

**ISSN 1454-9174**



**ANNALS  
OF THE  
UNIVERSITY OF PETROȘANI**

**MINING  
ENGINEERING**

**vol. 22 (XLIX)**

**UNIVERSITAS PUBLISHING HOUSE  
Petroșani – ROMÂNIA, 2021**

**EDITOR OF PUBLICATION**  
**Prof. PhD.eng. Sorin Mihai RADU**

---

**ADVISORY AND EDITORIAL BOARD OF MINING ENGINEERING**  
**ISSUES**

**ADVISORY BOARD**

Prof. PhD. Eng. Zacharis AGIOTANTIS	Technical University of Crete - Greece
PhD. Habil Eng. Marwan AL HEIB	Ecole des Mines de Nancy, INERIS, France
PhD. Eng. Horea BENDEA	Politecnico di Torino, Italy
Prof. PhD. Eng. Raimondo CICCUCO	University of Cagliari, Italy
Prof. PhD. Eng. Carsten DREBENSTEDT	Technische Universität Bergakademie Freiberg – Germany
PhD. Eng. Edmond GOSKOLLI	National Agency of Natural Resources, Albania
Prof. PhD. Eng. Victor HARCENKO	Moscow State Mining University Russia
Assoc. Prof. PhD. Eng. Ventsislav IVANOV	University of Mining and Geology – Sofia - Bulgaria
Assoc. Prof. PhD. Eng. Charles KOCSIS	University of Nevada, Reno, U.S.A
Prof. PhD. Eng. Andrei KORCEAK	Moscow State Mining University Russia
Prof. PhD. Eng. Gheorghe MORARU	Technical University of Moldova – Chişinău, Moldova
Prof. PhD. Eng. Roland MORARU	University of Petroşani
Prof. PhD. Eng. Jan PALARSKI	Silesian University of Technology, Gliwice, Poland
PhD. Eng. Raj SINGHAL	Int. Journal of Mining, Reclamation and Environment - Canada
Prof. PhD. Eng. Ingo VALMA	Tallin University of Technology – Estonia
Prof. PhD. Eng. Işik YILMAZ	Cumhuriyet University – Istanbul, Turcia

**EDITORIAL BOARD**

Editor-in-chief:	Prof. PhD. Eng. Ilie ONICA	University of Petroşani
Deputy editors:	Assoc. Prof. PhD. Eng. Dacian-Paul MARIAN	University of Petroşani
	Assoc. Prof. PhD. Gabriela DUMBRAVĂ	University of Petroşani
Associate editors:	Prof. PhD. Eng. Victor ARAD	University of Petroşani
	Assoc. Prof. PhD. Eng. Camelia BĂDULESCU	University of Petroşani
	Prof. PhD. Eng. Eugen COZMA	University of Petroşani
	Prof. PhD. Eng. Ioan DUMITRESCU	University of Petroşani
	Assoc. Prof. PhD. Eng. Emilia DUNCA	University of Petroşani
	Prof. PhD. Eng. Dumitru FODOR	University of Petroşani
	Prof. PhD. Eng. Mircea GEORGESCU	University of Petroşani
	Prof. PhD. Eng. Tudor GOLDAN	University of Petroşani
	Lecturer PhD. Eng. Ladislau RADERMACHER	University of Petroşani
	Prof. PhD. Eng. Ilie ROTUNJANU	University of Petroşani
Prof. PhD. Eng. Mihaela TODERAŞ	University of Petroşani	
Prof. PhD. Eng. Ioel VEREŞ	University of Petroşani	

---

**Editorial office address:** University of Petroşani, 20 University Street, 332006, Petroşani, Romania, Phone: (40) 254/54.29.94, 54.25.80, 54.25.81, 54.25.82, 54.97.49, Fax: (40) 254/54.34.91, 54.62.38, [www.upet.ro](http://www.upet.ro), E-mail: [ibol@upet.ro](mailto:ibol@upet.ro)

---

## CONTENTS

TERLECZKI A.E., GEORGESCU M. - <i>Solutions regarding the landscape framework of the Petrila post-closing mining perimeter</i> .....	5
NIMARĂ, C. - <i>Urban recovery of the industrial buildings in Romania</i> .....	35
MARIAN D.P., ONICA I. – <i>Land surface subsidence under the influence of the underground mining of the Ocnele Mari rock salt deposit</i> .....	41
ROMAN L. - <i>The influence of underground mining on the stability of land at Jiu Valley mine surface</i> .....	53
VANGU G.M., DIMA N. – <i>Making and exploiting a GIS database related to the surface mining areas</i> .....	81
MARIAN D.P., ONICA I. - <i>Analysis of the stability of the rooms and resistance structures at the Ocnele Mari – Cocenești Salt Mine, based on safety factor</i> .....	99
MARIAN D.P., ONICA I. - <i>Numerical modeling of the stability of the resistance structures from Ocnele Mari Salt Mine using the finite element method</i> .....	113
TOMUȘ V.A., GEORGESCU M. - <i>Solutions for isolating zone with danger of flood during period of mine closing</i> .....	127
MANGU S.I. - <i>Deposit of useful mineral substances - economic resource and factor of production</i> .....	135
MANGU S.I. - <i>Considerations on the rental system in the mining branch</i> .....	143
TIUZBAIAN I.N., HULEA L. - <i>Precious metals stocks investments. Status of precious metals in Romania</i> .....	151
BĂDULESCU C. - <i>Energy assessment of coal in the context of environmental protection</i> .....	157
CIOLEA D.I., BĂDULESCU C., BERCA M. - <i>The circular economy and the sterile sludge from Coroiești</i> .....	165
BĂDULESCU C. - <i>Use of industrial waste in the context of the circular economy Case study - power plant ashes</i> .....	175
SÎLI N., APOSTU I.M. - <i>Evaluation of Bâc River water quality</i> .....	185
NIMARĂ, C. – <i>Analysis of the thermal and pluviometric regime in Râmnicu Vâlcea, in the context of climate change</i> .....	195

NIMARĂ, C. - <i>The influence of urban climate on the residents of Râmnicu Vâlcea City</i> .....	201
MORARU R.I., POPESCU-STELEA M. - <i>Comparative risk assessment for „drilling rig operator“ in oil and gas onshore drilling company</i> .....	207
<i>Index of authors</i> .....	225
<i>Instructions for authors</i> .....	226
<i>Scientific reviewers</i> .....	229

## **SOLUTIONS REGARDING THE LANDSCAPE FRAMEWORK OF THE PETRILA POST-CLOSING MINING PERIMETER**

**Terleccki Andreea Eliza<sup>1</sup>, Georgescu Mircea<sup>2</sup>**

**Abstract:** *The work was elaborated in order to define a coherent way of landscape organization of the Petrila mining perimeter towards the orientation of the urban development of the city. After a presentation of the main constructions from mine yard and of the dumps, which may have a possible reuse, the paper proposes some solutions for post-closure redevelopment of the Petrila mine yard and related dumps, by creating a similar natural, anthropic and cultural landscape with the local one necessary for the development of an ecological tourism in the same area. The solutions presented are descriptive, without going into details of interior design that would require a diverse participation in some specialized in interdisciplinary fields. In the final part, an estimate is made of the costs necessary for the vegetation of the areas on the dumps that remain free after the execution of the proposed objective and a possibility is made to stagger the execution of the necessary works on the mine yard and in the dumps.*

**Keywords:** *Petrila mine, landscaping, post-closure*

### **1. INTRODUCTION**

Landscaping consists of a set of works combining natural factors with anthropogenic factors in order to achieve an artistic ensemble that fulfills the following functions: ecological function, public utility function and complementary function.

The landscape is the part of nature contained in a single glance and which forms a set of natural elements (relief, soil, water, air, vegetation) and/or anthropogenic (settlements, constructions, industrial exploitations) which has functionality and which manifests itself as a whole.

The legacy of the industrial age in Romania is often ignored or even completely erased in the name of the land resource or the scrap metal it has. Petrila's industrial site has a remarkable value in view of Romania's national industrial heritage. Petrila mining perimeter is a valuable ensemble from a patrimonial, social and economic point of view for this area, but also for the whole country. The conservation and transformation of parts of the industrial heritage ensemble creates a unique opportunity for reconciliation with the various stages in the history of this place, which goes back to the contemporary period.

Petrila mine, the oldest in the Jiu Valley, is the genesis of mining in this area. It is the only one that preserves elements from all the important stages of development of

---

<sup>1</sup> *Ph.D. Eng. University of Petroșani*

<sup>2</sup> *Univ. Prof. Ph.D. Eng. University of Petroșani*

the industry, from the first signs of industrialization and represents a clear reflection of the history of the mining complex.

## **2. GENERAL DATA ON THE PETRILA POST CLOSING MINING PERIMETER**

### ***2.1. Geographic position***

The Petrila mining perimeter is located in the eastern part of the Jiu Valley coal basin – Romania.

From an administrative point of view, the Petrila mining perimeter belongs to the city of Petrila where the Petrila mine is located (fig.1).

Access to the region is provided by the electrified railway Filiași - Simeria and DE Craiova - Tg. Jiu - Petroșani - Deva - Oradea, as well as the county road Petroșani - Lonea. [7]



**Figure 1.** Petrila mining perimeter location map [9]

The dump perimeter develops in the immediate vicinity of the mining precinct and continues to the southern slope of the Rusalin brook and the northern slope of the Maleia brook, both tributaries of the East Jiu river.

The land on which the dump is located is an old plateau that includes the balance area between the southern tributaries collected by the East Jiu and the northern tributaries of the Maleia brook. The surface of the plateau destined for the dump is of approx. 86 ha.

The altitude of the plateau is comprised between maximum values formed by the Maleia Mare points with Zănoaga peak (+745.46m) and Maleia Mică (+740.60m) and minimum values of 670-720m.

Initially, the plateau intended for landfill had a quiet morphology with small slopes not exceeding 10° (except for the southern area from the village of Maleia, where

the slope of the land exceeds 10°, but due to the influence of underground exploitation of coal layers has a completely modified morphology) [7].

## ***2.2. Geotechnical and hydrogeological features***

The bottom of this mining field is formed by the crystalline schists of the Getic domain. The oldest formations that make up the stratigraphic succession of the Petrila mining field belong to the lower conglomerate horizon. This horizon is also represented here, as in the rest of the basin, by conglomerates or large blocks, trapped in a red clay cement.

Over the bottom formed by crystalline schists of the Getic type, the lower conglomerate horizon, or the bed formation, lies discordantly and overlapping. Above the deposits of this horizon is the productive formation, whose thickness reaches approx. 500m [2].

Knowledge of the foundation of the dump and its geotechnical peculiarities is absolutely necessary, having a great importance both in choosing the location and in establishing the arrangement works, as well as in the design and especially in the construction of the dump.

The load-bearing capacity of the bottom rocks and especially their stability condition on the one hand the geometry of the dump, and on the other hand the construction mode.

The direct bottom of the dump belonging to Petrila mine consists of topsoil, which was not removed before the sterile material was deposited. The thickness of the vegetal soil layer is variable in the dump perimeter, reaching values of up to 2 - 5m.

The soil is represented by a clay-sand dust, the share of fine fractions, with a diameter of less than 0.05mm, being 54.1%, which determines a high sensitivity to water, and the water retention capacity can lead to worsening. significant increase in mechanical strength and load-bearing characteristics.

The basic bottom is the one characteristic of the Jiu Valley, being represented by microconglomerates, fine sandstones and non-stratified clays.

In the Petrila perimeter, no special hydrogeological problems were reported that would require special research in this direction. The source of supply of the aquifer horizons is, first of all, the atmospheric precipitations and, secondly, the water infiltrations that occur from the valleys of the East Jiu and Jieț streams. During periods of heavy rainfall, possible infiltrations into the mining works located near the outcrop areas of the coal seams are possible, without creating special situations. The speed of water flow is reduced, due to the rocks present in the area, which have permeability coefficients with low values. [9]

## ***2.3. Climate***

The whole area of Jiu Valley has an alpine microclimate, with a predominantly humid and cold character with significant amounts of precipitation in the form of rains and snow that vary during a year.

An important zonal phenomenon is that of stagnation and cooling of slippery air from the height on the bottom of the depression, the so-called thermal inversions, a phenomenon specific to the cold season, when large areas are covered with fresh snow that transmits a much lower temperature than the adjacent air from height.

Abundant rainfall (800 - 1200mm annually) is reported locally, particularly in June and July. Highly cloudy days reach over 200 annually. The annual relative humidity regime has a main maximum in December (93%) and a main minimum recorded in March - April (77%).

During the cold period of the year (November - April), some of the precipitation falls in the form of snow, and the snow layer has maximum values in January and February, constituting an important water reserve. Characteristic for the intermountain depression of the Jiu Valley is the low level of evaporation phenomenon due to the persistence of cloudy days.

The multiannual monthly averages of air temperature are shown in Figure 2.

Observations on the climate of the Petroșani Depression show a gradual decrease in thermal values and increase in precipitation with altitude, a relatively mild climate on the depression to a rather harsh one specific to the Parâng, Retezat or Șureanu Mountains. [5]

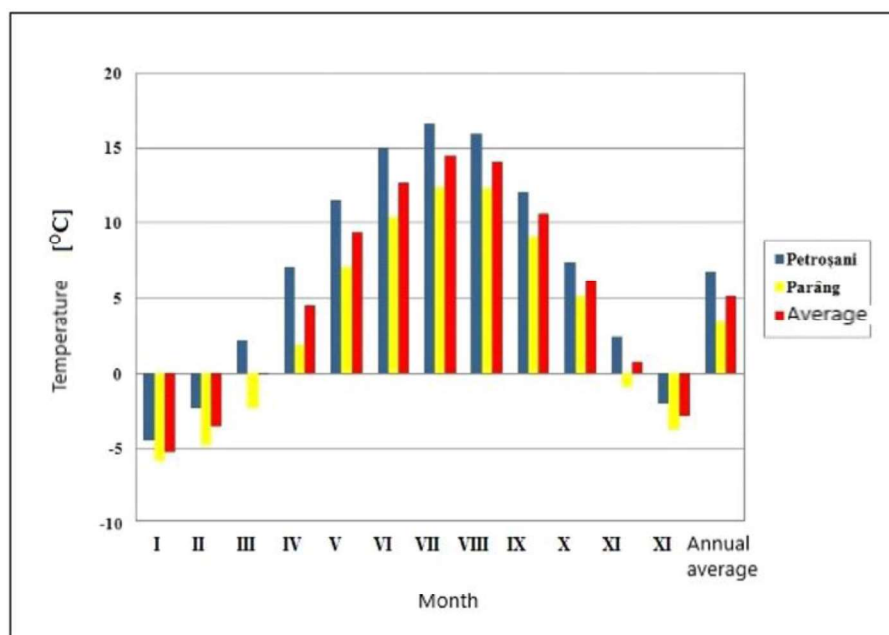

**Figure 2.** Multiannual averages temperature [5]

The climate encountered in the dump area is similar to the Petroșani depression area, but due to biological and biochemical processes that occur in the soil and primarily decomposition of organic substances, the quality of telluric air is different from that of atmospheric air, the percentage of oxygen being higher, low and carbon dioxide, higher.

Following the wind frequency (%) and its speed (m/s) on directions, the following situation is found (see table 1.)



**Table 1.** Wind regime

<b>Direction</b>	<b>N</b>	<b>NE</b>	<b>E</b>	<b>SE</b>	<b>S</b>	<b>SV</b>	<b>V</b>	<b>NV</b>	<b>Calm</b>
Frequency, %	4,9	1,5	0,6	2,8	12,6	6,1	2,7	5,0	64,9
Speed, m/s	2,0	1,2	0,4	1,5	3,6	2,5	1,8	2,3	-

#### **2.4. Pedological characteristics**

The soil and subsoil consists of a crystalline foundation and molasses sedimentary deposits of cover. The crystalline foundation appears up to date on the basin frame, being made up of metamorphic rocks with different degrees of metamorphism belonging to the native Danubian as well as the Getic canvas. The Getic crystalline arises in the northeastern frame and partially in the southern one and is represented by gneisses, schists, quartzites and amphibolites. The Danubian crystalline lens is developed in the southern frame and partially in the northern one and is represented by gneisses, crystalline limestone, shales and quartzites.

The geological works of prospecting, exploration and exploitation highlighted the existence of 22 seams of coal, characterized by areas of spread, thickness and variable quality.

The zonal soils formed on sedimentary rocks (gravels, sands, sandstones, marls) located at the edge of the depression with the mountain, but also on the slopes with medium and low inclination, there are brown soils, or with transition character from the brown ones to the acid brown ones.

Acid brown soils are present at the base of mountain slopes and reach in some sectors on the main peaks. They are usually found either on acidic and intermediate rocks, but also on limestone, if the soil is greasy. They have a sandy-loamy or even sandy texture, without accumulation of clay in the lower horizons and are generally covered with beech forests, on the northern peak of Vâlcan and Parâng and by the mixture of beech with spruce and spruce.

In the sectors where the meadow vegetation predominates, there has been a transformation of the superficial horizons of the profile by humus enrichment and enrichment on an appreciable thickness.

In the higher parts of the Petroșani Depression, on acid rocks, there are subalpine acid brown soils, with a transitional character to the brown soils, which are characterized by a large amount of acid humus, but with very little mineral material in the upper horizons.

The petrological mining perimeter from the lithological point of view, in the upper part, has a layer of vegetal soil with an average thickness of 0.30m, followed by a coarsely consolidated coarse gray sandstone.

Soils with variable thicknesses form a continuous layer throughout the region, consisting of sandy clays, gray, yellowish-green, sporadically black. For areas with excess water, the algorithm based on texture and degree of packaging predicts high vulnerability (extremely vulnerable) compared to the other algorithm that predicts moderate values of vulnerability (stable / unstable). [5].

## 2.5. Pedological characteristics

### 2.5.1. The natural environment

The Petrila city is located in the eastern part of the Petroșani Depression, an area that, in the last century, has been identified with the mining industry, whose decline, however, since the post-December period has caused the worsening of the entire regional system.

The components of the environment were strongly affected by the mining activity, taking into account its special magnitude. As a result, a significant part of the natural environment, especially at lower altitudes, has undergone drastic changes with the most unfortunate results. Rivers and air were heavily polluted, vegetation was affected by deforestation and other operations, and soil was contaminated.

In particular, tailings dumps represent an environmental damage with significant risks due to the possibility of slipping. They are, in fact, large agglomerations of waste resulting from the transport, sorting and processing of coal.

The Petrila mine used the Ramura I-V Petrila dumps located in the southern part, on the nearby hill. It has an area of 195,900m<sup>2</sup>, a designated volume of 3,755,454m<sup>3</sup> and a used volume of 336,231m<sup>3</sup>. Anthropogenic and natural conditions are characterized by the presence of households, the existence at a distance of about 500m south of the DN7A road, connecting routes with limited traffic and restricted movement of people. The lake on the north side belongs to the Pro Pescar Organization and Lake Știurț is on the south side. The land includes poor vegetation, pastures, bushes and shrubs especially birches, willows and acacias; erosion and landslides also occur [4].

The space inside the unit, in some places, is characterized by massive agglomerations of industrial waste, especially rubble, boulders, equipment debris, wagons, railway rails, etc.

The spaces in the vicinity of the mine were also affected by the former industrial activity, containing dilapidated buildings, remains of equipment, and the land is soaked with residual materials and overgrown with spontaneous vegetation (fig.3).

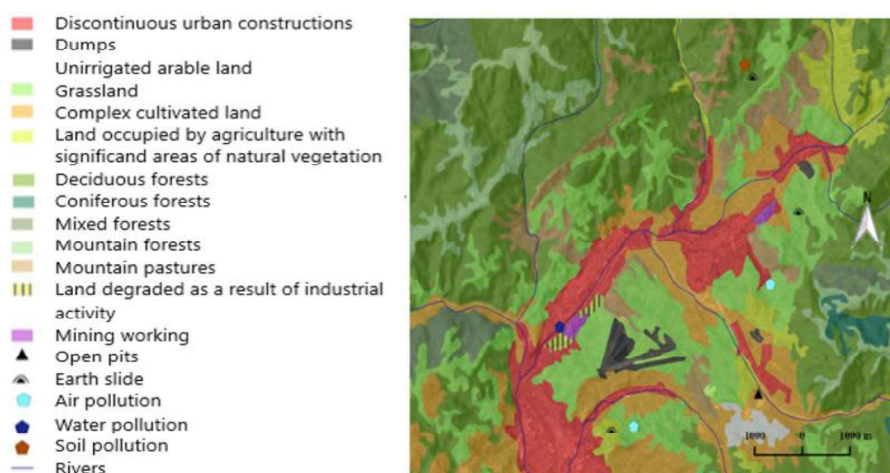

Figure 3. Map of environmental risks in Petrila area [11]

### *2.5.2. Wealth management*

Petrila mine stands out for the special value of its industrial heritage, due to its pioneering quality in mining, being the first official mining operation (December 1869) and implicitly, the objectives that mark important stages in the history of this activity, most of which have been preserved. Probably a factor as to why they're doing so poorly.

Among the most valuable objectives are those from the beginning of operation: Deak Shaft (1868), Mechanical Workshop buildings.

Another series belongs to the 1930s: the Old Preparation (1931), the Center Shaft and the Access Hall (1938), the Administration buildings. The most recent are: the sorting building and the Shaft with Skip (1987).

The current situation of the mining perimeter is unpleasant. The recent turmoil and uncertainty, which has resulted in repeated destruction, has left a deep imprint on the objectives.

### *2.5.3. Framing in the territory*

Analyzing the location of the Petrila mine in relation to the residential space (fig.4), a significant fault is noticed. The location of the prime minister on the outskirts of the city aimed to protect the inhabitants from its negative effects, but also to carry out a series of processes indispensable to the industry, which could not be carried out in the immediate vicinity of the city. The proximity of the East Jiu river, as well as the southern Piedmont area ensured an efficient supply of the necessary natural resources.

Against the background of the closure of the unit, however, this state of isolation contributed significantly to the worsening that occurred. The lack of contact with the public space, allowed the inhabitants not to have access to the demolitions and other damages produced in the mining area. The gradual degradation of this space thus occurred, unhindered.

Considering the strong recognition that the mine enjoys in the local community, as a true identity factor and observing the location of other sites with cultural value in the locality, it can be deduced that mining is fractured by public space. This situation has negative implications due to the lack of an efficient connection of the site with the locals, but also if we take into account the fact that the only alternative designed proposes a sustainable development in which the mining space is integrated into the public space. The element that separates the mining area from the locality is East Jiu river, which is crossed by a street that enters the unit and several bridges. These are the only access roads to the Petrila mine area.

However, some positive aspects can also be listed which, through appropriate management methods, can contribute to improving access and integrating this area into the public space. Probably the most important aspect is the existence of a parallel alley of the Eastern Jiu that can be redesigned and used as a link between the community area and the industrial-mining area. Moreover, the Bosnia district, located at the eastern end of this alley, will be removed from isolation.

Another favorable factor is the existence of vacant spaces near the mining precinct which, under favorable landscaping conditions, can contribute to increasing the attractiveness of the area. However, this space also has negative aspects by finding some ruins, traces of the old activity. The land is rather in a state of disrepair, abandonment, which contributes to the strengthening of that state of distance from the local community.

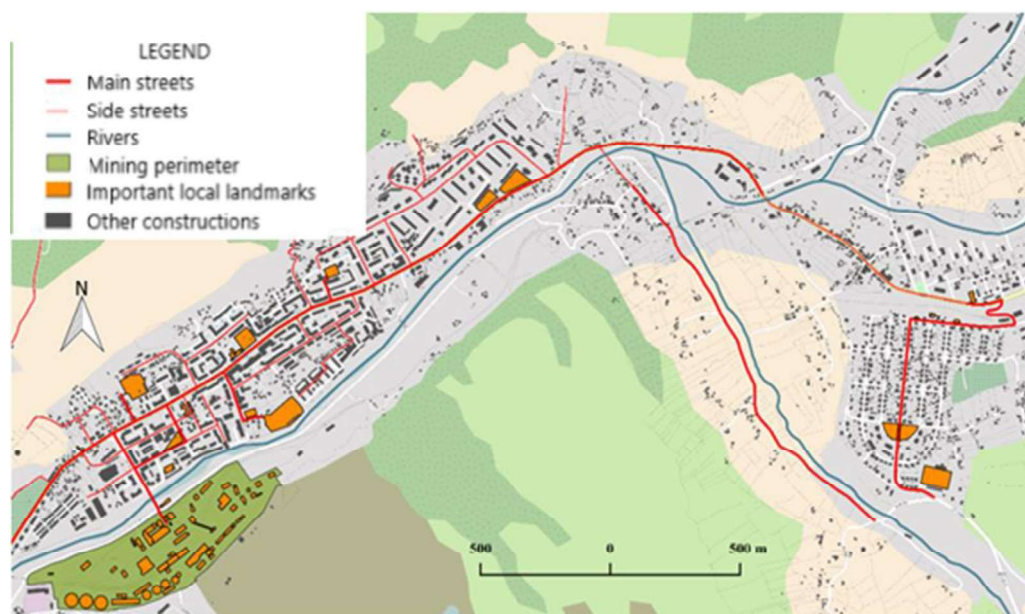

**Figure 4.** The main objectives o Petrila municipality and the connections between them,  
Source: Open Street Map

### **3. GENERAL CONSIDERATIONS REGARDING LANDSCAPE REINTEGRATION**

#### ***3.1. Landscape reintegration of technostructures***

Over time, countless definitions of the concept of landscape and geographic landscape have been imposed. Most of them refer to the objective landscape, i.e. to the concrete elements of the landscape and to the relations between them, avoiding its subjective reality. Even if the emphasis is on the objective reality of the landscape, i.e. on what is measurable, palpable, concrete, it becomes at some point a subjective reality [1].

The post-industrial land area is that area used in the past for a certain industrial activity of production, transport or storage that is currently unused or decommissioned and which in the past played an important role in the economic development of the region.

The term ecological rehabilitation implies more than a simple ecological restoration of the functions that the ecosystem had before the anthropic intervention and whose effects were felt on the relief, soil, water, microclimate and biodiversity. This term implies a reconstruction of the affected area both by its insertion in the environment and in the economic circuit.

The landscape obtained from the reconstruction of the area affected by anthropogenic activities should be aesthetically or visually compatible with the nearby natural landscape. It is also necessary that the land be gravitationally stable and not subject to wind or rain erosion, representing a suitable substrate for vegetation.

In the ecological arrangement of a territory, the parameters that must be taken into account are: the local economic system, the specifics of the activities created so far, the characteristics of the elements of the natural system, the characteristics of the social and urban system and the regional aesthetic aspects.

Many specialists both in the country and abroad using different procedures and ways of thinking have tried to solve the problem of ecological planning by establishing a set of ecological planning principles:

- *The principle of globality or intercausality*
- *The principle of environmental autonomy*
- *The principle of minimum sizing and reversibility*
- *The principle of economy*
- *The principle of respecting tradition*
- *The principle of transparency and democracy*

There are modern data collection and processing techniques today that lead to easy, fast and accurate planning operations. It is therefore an obvious need that the population resident in that area also participate in the realization and control of the planning activity, the whole community being in discussion in this process of territorial planning.

In order for this process to be truly completely democratic, the following will be pointed out:

- *Simplicity of the process* - which means not to get lost in terms of specialty or various digressions;
- *Be clear and transparent* - the planning process is therefore organized and managed in broad daylight, not closed in files and studies inaccessible to residents;
- It must also be *common* - any resident citizen must therefore be seen as the first person in their own environment;
- To be *objective* - which therefore means that all operations must be justified by precise requirements and resolved on the basis of objective scientific criteria;
- And be *legible* - meaning that anyone can read it easily and easily understand the solutions, even those who do not participate in the development of any project, to be able to evaluate them and even apply them. [5]

Underground mining does not involve a direct visual impact, if we refer to changes that occur only in the structure and dynamics of the underground. However, the post-exploitation effects give both the environmental elements and the landscape a discordant note, and the possibilities for reconstruction are limited.

In the international specialized literature there are a series of methods, concepts and models of land rehabilitation degraded by mining activities, ideas that were taken over by Romanian specialists, but often used incorrectly, representing only simple translations.

Although they aim at the sustainable development of the region, these post-extraction rehabilitation measures sometimes determine the continuation of the degradation process, which is reflected in the economic efficiency. In order to avoid this phenomenon, special attention should be paid to the choice of redevelopment methods.

The mining activity usually has as final result a type of anthropic landscape characterized by two forms of manifestation from a structural point of view: a positive form of relief (tailings dumps, anthropic terraces, etc.) and several forms of negative relief (coal open pits, craters, excavation canals, uncovered lands, excavations etc.). The basic principle regarding the rehabilitation of these degraded lands starts from the idea of compensating or balancing the material masses, in the sense that the forms of sub surveying relief must be filled, and the forms of supra surveying relief must be leveled.

Landscape architecture has its own means of work, often using the plant element as a "building material".

Post-exploitation reconversion ( $R_p$ ) requires in-depth studies based on recreational landscape development, using techniques specific to landscape architecture ( $A_p$ ) and industrial design ( $D_i$ ), i.e.:

$$R_p = f(D_i, A_p) \quad (1)$$

The anthropic mining relief can be part of the process of functional and aesthetic reorganization through simple or complex programs, depending on: the available financial resources, the degree of damage to the environmental components and the local specificity. Fast solutions with low costs are accepted, which will transform degraded territorial complexes into spaces with recreational values.

Completion of mining activities and ecological reconversion of degraded areas requires a complex of administrative and engineering measures. After the technical operations specific to the closure and conservation of the mining fields, the functional rehabilitation and the landscape reintegration of the former mining field follow.

An approach that takes into account the specificity of the site, the latest techniques and methods in terms of ecological reconversion and the expectations of the local community is needed. It is also important that the final shape of the rehabilitated land is as close as possible to the shape of the natural land, taking into account the fact that the four important characteristics of aesthetics are: shape, line, color and texture.

If the territory on which the anthropogenic factor carried out its industrial activity does not present high potential from the landscape point of view nor harmonious links with other tourist resources, then the degraded lands can be recovered or improved by building public parks and gardens, artificial lakes, water parks and botanical gardens (fig.5).

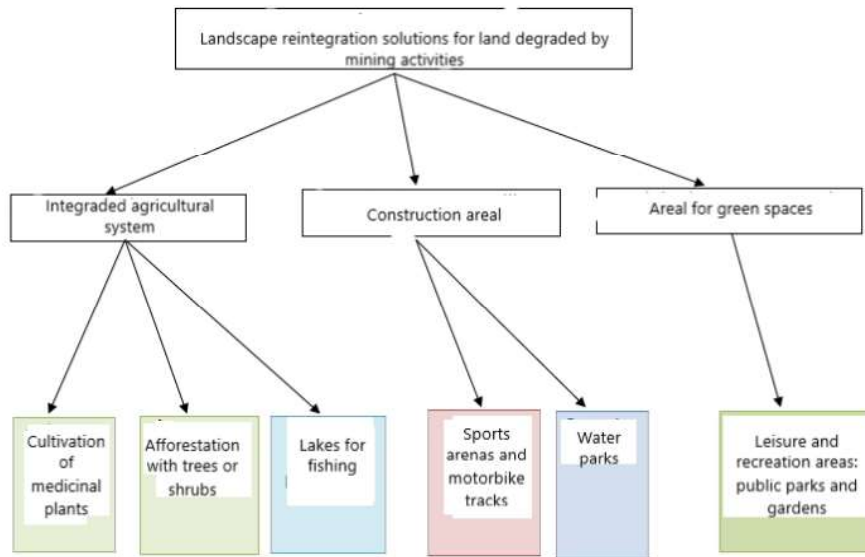

**Figure 5.** Landscape reintegration solutions for lands degraded by mining activity [5]

### 3.2. Restoration of heritage buildings

According to Government Ordinance 68-1994 on the Protection of the National Cultural Heritage, Article 1 provides: „the natural environment and the historical environment constituted on the territory of Romania, of the national and universal history and civilization.....real estate or ensembles of real estate that present value from an archaeological, historical, architectural, religious point of view, urban, artistic, landscape or technical-scientific are historical monuments”.

Thus, when referring to "Protection of buildings with heritage status", it means any provision, idea, measure, law, code or even intervention that ultimately leads to the rescue from degradation or even destruction of a building that is part from the national or universal cultural heritage.

Three stages can be defined, with specific content and objectives, these stages are strictly followed in the restoration process: analysis, diagnosis and intervention/therapy.

The object of the critical *analysis* is to obtain initial information on the construction (location, materials used, construction techniques, structural design) as well as data related to the construction history or the state of degradation in the elements that can influence the structural behavior and provide useful data on the specific mechanism. degradation or damage.

The critical analysis formulates a first evaluation of the construction, having a strong interpretive character of the complex symptoms that affected the construction, specifying also the necessary investigations for a more correct diagnosis.

The *intervention* method, the materials to be used and the installation techniques in case of constructions with historical value to be protected must be in accordance with the technological characteristics of the structure to be restored, characteristics determined in stages of construction analysis.

In the desire to make the best choice, the use of traditional materials and techniques is the most appropriate when this is possible, but not excluding the parallel use of modern materials and techniques. The use of modern techniques must be shown to be appropriate and necessary in relation to other techniques compared to other techniques, even traditional ones.

The final stage of the restoration of a construction is the construction site, place where the first analyzes were made and from which information used in the process of evaluation and realization of the project was gathered, and also the place where the application takes place (implementation). of the established intervention solutions. It should be emphasized that due to the special character of the structural restoration works, once the works on the site start, the design stage is practically not completed, whenever changes are possible during the execution in any of its phases [6].

#### **4. PRESENTATION OF THE ENCLOSURES AND ADJACENT SURFACES**

##### ***4.1. The Center Shaft***

The Center Shaft of the Petrila mine (fig.6) has been built since 1943. The electrical part was taken care of by Siemens Berlin, and the mechanical part was provided by Demag. It was that turbulent period of the war, when coal was an important and by no means marginal resource, as it is now considered.

On November 18, 1943, the mounting of the hoisting engine of the Center Shaft began, which were interrupted in 1944 and resumed in the period 1947-1948 when the works on the new extraction complex were completed - the Center Shaft [2].

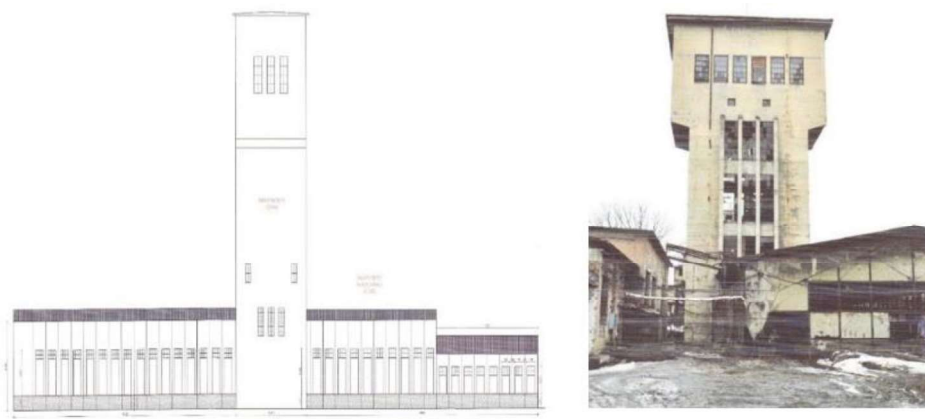

**Figure 6.** Center Shaft head frame [9]

##### ***4.2. The Center Shaft***

The qualification school (fig.7) was built in the mine yard, in order to train the skilled workers in all the trades necessary for the proper functioning of the activities at the Petrila mine. [2]

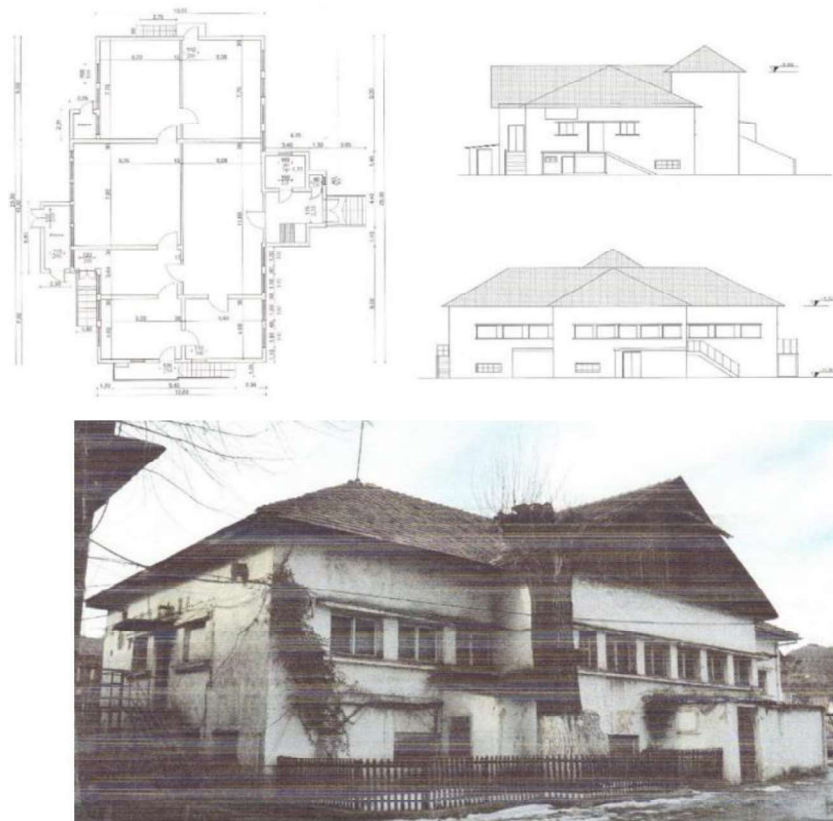



**Figure 7.** Qualification school and dispatching office (main front) [9]

### **4.3. The Center Shaft**

For the execution in the underground of the mine of the works that were carried out in optimal conditions, participation in interventions in case of damages, rescue in case of mining accidents or catastrophes, at the Petrița mine the mining rescue station was built (fig.8), being one of the best organized in the Jiu Valley, staffed with professionally trained staff, mentally, physically and morally [2].



**Figure 8.** Rescue station [10]

#### **4.4. The mechanical workshop**

In the immediate vicinity of the Deak adit, the construction for the mechanical workshop (fig.9) of the new mine with a built area of 800m<sup>2</sup> was completed. Mine-car were made here.

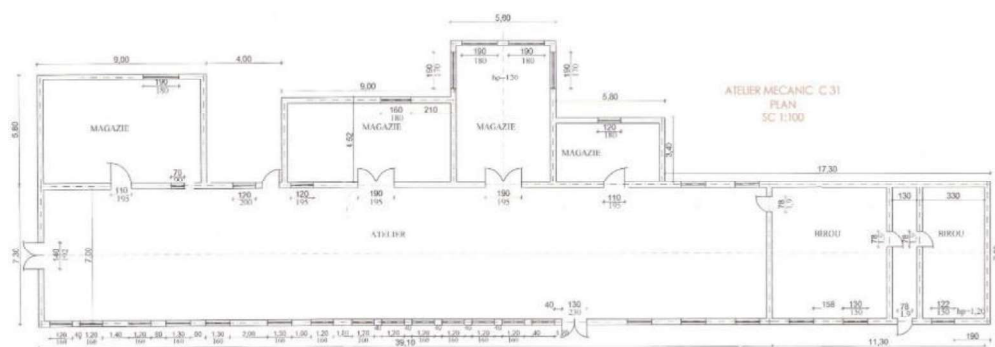
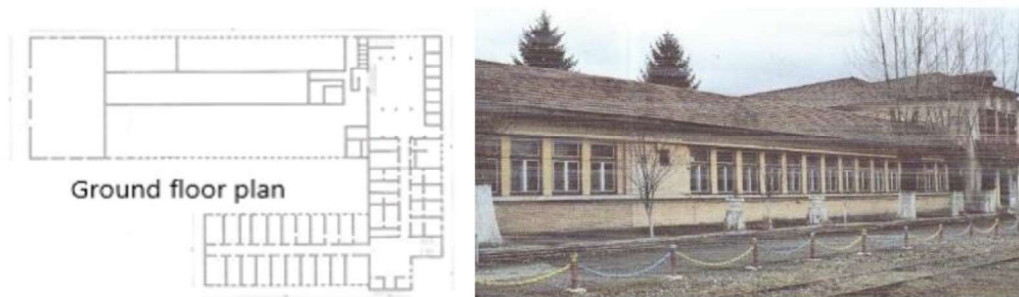

**Figure 9.** Mechanical workshop [9]

#### **4.5. Administrative building**

The administrative building (fig.10) of the mine was built together with the central shaft, the construction services being executed by the Nicolau company from Braşov in the years 1947-1949.

It has a built area of 3415m<sup>2</sup>, and the developed one of 6345m<sup>2</sup>.



**Figure 10.** Administrative building [9]

#### **4.6. *Sorting station***

To sort the extracted coal, this station was built (fig.11) with a processing capacity of 70m<sup>3</sup>/h. The installation was provided with a Westfalia type vibrating screen system, driven by a 26HP electric motor, which sorted the coal into sizes: 0-10; 10-20; 20-30; 30-40; 40-80 and over 80mm [2].



**Figure 11.** Overview of the sorting station [2]

#### **4.7. *The old Preparation 1927-1931 (fig.12)***

In 1929, the contract with the Czechoslovak company "Skoda" from Pilsen was concluded for the execution of the preparation, and the company "Astra" from Arad took care of the construction and assembly of the metal parts.

Over time, the Preparation has undergone a series of technical changes, through the implantation of new installations, such as forging coal for forging, drying and

flotation. The changes brought in the installations after 1938 referred to the size of the degree of recovery, the increase of the possibilities of obtaining a superior quality and of intermediate products that were capitalized, the purification of the waters. The works started in this field after 1938 led to the increase of the processing capacity from 310t/h, as it was initially foreseen, to 450t/h, after 1943 [2].



**Figure 12.** Overview of the old Preparation [2]

#### **4.8. Technostructures**

The direct bottom of the dumps consists of clayey-dusty rocks whose resistance characteristics are influenced by humidity due to the high content of pelitic material.

The dump consists of a mixture of soft rocks and hard rocks deposited in a single step with heights between 8 - 10m and 30m through funicular installations.

The petrographic nature of the dumped material highlights the presence of clayey rocks (30%), marls (6.6%), clayey sandstones (59%), coal shales and coal fragments (4.4%), generally rocks that crumble easily.

As a result of the study of the topographic plans, the main geometric elements of the five dump branches were determined (table 2) [5].

**Table 2.** Geometric elements of dump branches

<b>No. crt.</b>	<b>Name of dump body</b>	<b>Length (m)</b>	<b>Area (ha)</b>	<b>Height (m)</b>
1	Angular station	-	3.1784	29.62
2	Branch I	800	7.5	17.32
3	Branch II	850	8.5	18.42
4	Branch III	900	9.5	19.04
5	Branch IV	1,714	3.7010	16.84
6	Branch V	1,560	2.1965	14.44
<b>TOTAL</b>		<b>5,824</b>	<b>34.5759</b>	<b>-</b>

## 5. SOLUTIONS REGARDING THE LANDSCAPE FRAMEWORK OF THE PETRILA MINING PERIMETER

The landscaping of the Petriřa mining perimeter has as main objective the regeneration of urban landscapes with a special positive impact on the cultural and social environment.

This complexly designed rehabilitation aims to raise the attractiveness of the city of Petriřa, increase the quality of the landscape and at the same time stimulate the cultural component.

From a social point of view, the purpose of the reclassification is to stop the decrease of the population by increasing the local jobs, developing several types of tourism valid throughout the year, a historical tourism of the industry and a tourism around the new designed space.

### 5.1. Solutions for arranging the premises

For the arrangement of the mining premises, I propose the following model of landscape reintegration (Table 3 and fig.13.) as follows [8]:

**Table 3.** Reconversion of mining premises

No.crt.	Current precinct	Future uses
1	Center Shaft	Escalade /climbing hall
2	Qualification school Administrative building	Museum
3	Rescue station	Library
4	Mechanical workshop	Concert hall land public place
5	Sorting station	Hotel
6	Old Preparation	Supermarket



**Figure 13.** Landscape and functional reintegration of the enclosures related to Petriřa mine [8]

### *5.1.1. For the Center Shaft*

Arranging the outer walls of the head frame of the Center Shaft for climbing; this sector of activity consists especially in the ascent or descent on buildings or any other structure with difficult access using the climbing equipment (fig.14). This activity will be mainly tourist-recreational, attracting people eager for adventure [8].



**Figure 14.** Overview of the Center Shaft head frame [8]

In this building will be arranged kiosks, toilets, as well as the center for renting climbing equipment (fig.15).

Qualified personnel will be provided to present the basics of safety, main climbing and retreat techniques and first aid.



**Figure 15.** View of the equipment and kiosk rental center [8]

*5.1.2. For the qualification school and the administrative building*

The buildings will be transformed into a museum dedicated to mining in Petrila, in them will be found elements that will transpose the visitor into the world of coal mining (fig.16) [8].

By opening this museum, the visitor wants to follow the exploitation route from the entrance to the premises, to the entrance to the underground.

Inside the future museum, rooms will be set up for exhibitions as well as film screenings.



**Figure 16.** Front (a) and side view (b) of mining Museum [8]

*5.1.3. For the rescue station*

In this enclosure will be arranged a library in which to carry out activities such as: book launches, art workshops, reading clubs (fig.17).



**Figure 17.** Side view of Library [8]

Culturally, participating in a reading club brings a number of advantages: the development of analytical thinking, the stimulation of the imagination, the development of compassion, the improvement of the ability to concentrate, the development of vocabulary (fig.18).

Economically, the opening of a library will create new jobs and implicitly generate higher revenues to local authorities through taxes.



**Figure 18.** Space for the Reading Club [8]

#### *5.1.4. For the mechanical workshop*

This precinct will have the role of restaurant as well as public place (fig.19 and 20a).

The warehouses related to the workshop will be restored and will be converted into bathrooms.

A stage will be built where different musical concerts will be held (fig. 20b).

Arranging a relaxation space in the immediate vicinity of the stage.



**Figure 19.** Overview of future restaurant [8]





**Figure 20.** Entrance to the restaurant (a) and view of the music scene (b) [8]

#### 5.1.5. For the sorting station

The sorting station will be transformed into an ecological hotel (fig.21) and will meet the following criteria:

- it will be energy efficient - the water will be heated using solar panels, also the heat losses will be limited by the superior thermal arrangement;
- exclusive use of recycled paper, use of ecological cleaning products;
- economically, the costs of building air conditioning are considerably reduced.

Currently, the city of Petrita does not have a hotel, its arrangement will increase the attractiveness of the city, will encourage and develop tourism.



**Figure 21.** Front (a) and overview of the eco-friendly Hotel [8]

#### 5.1.6. For the old Preparation

This precinct will be transformed into a supermarket (fig.22a), activities will be carried out for the sale of products, market services and public catering.

A space for recreation will be arranged in the immediate vicinity of the shopping complex (fig.22b)

The arrangement of this commercial complex brings a plus in view of the socio-economic aspect by accelerating the creation of jobs.



Figure 22. Supermarket: front (a) and terrace (b) [8]

### 5.2. Solutions for arranging dumps

Starting from the western part of the dump plate, the morphostructure is in the form of a fan with 5 branches. The five branches are arranged from west to south in the following order: branch III, I, II, V and IV, forming angles of  $9^\circ$ ,  $14^\circ$ ,  $16^\circ$  and  $24^\circ$ , respectively [7].

The functional and aesthetic reintegration of the geomorphological environment affected by the anthropic activities within the meadow sector of the Eastern Jiu implies the accomplishment of a redevelopment that must create the necessary conditions for the regeneration of the soil fertility or conditions for constructive purposes.

For the arrangement of tailings dumps, the following model of landscape and functional reintegration is proposed (fig. 23) [8].

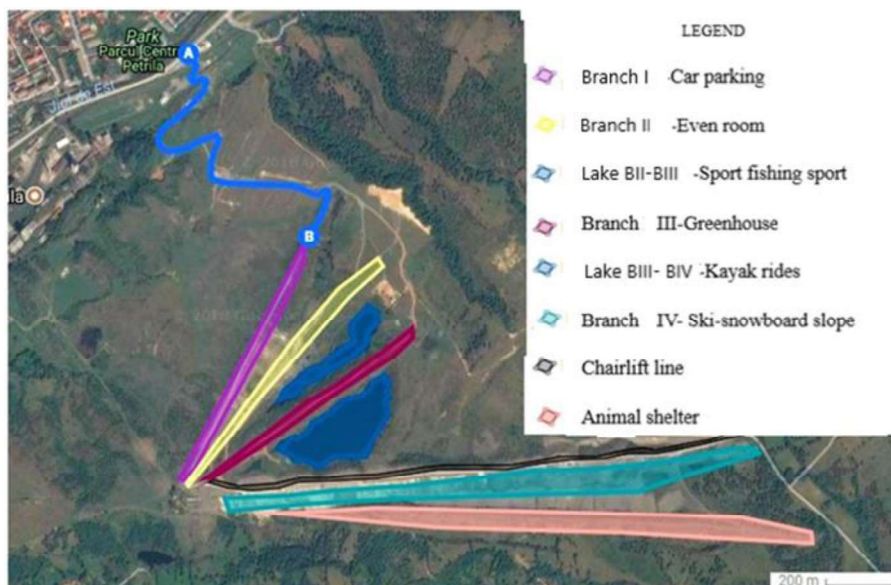

Figure 23. Landscape and functional reintegration of dumps Petrila mine [8]

For the landscape and functional reintegration of the tailings dumps, the following works will be carried out:

- construction of the access road to the future recreational space for vehicles, and creation of a bicycle track;
- arranging the pedestrian sidewalk to facilitate access to all proposed objectives;
- construction of parking spaces on the Branch I (fig. 24);
- on Branch II a building will be arranged which will become a public space, according to the community events on a larger scale. An event hall will be built; forest protection curtains will be planted around this room to significantly reduce noise; a bathroom will be set up (fig.25);
- the lakes between Branch II, III and IV will be arranged for recreational purposes. The lake between Branch II and Branch III will be arranged for sport fishing, there will also be two centers for renting fishing equipment (fig.26). The lake between Branch III and Branch IV will be arranged for recreational purposes, with boats available (fig. 27). A rental center and a bathroom will be built here. In terms of flora, species of native origin will be planted around this water basin. Infiltration and surface water management works will be carried out for the permanent supply of the lakes.
- arranging a greenhouse with diversified flora on Branch III (fig. 28);
- arranging Branch IV in the form of a ski / snowboard slope during the cold season, and in the rest of the year it will be possible to practice cycling on this plateau;
- transformation of the funicular into a chairlift in order to increase the tourist accessibility during the winter;
- arranging the Branch V in the form of a children's park and building an animal shelter (fig. 29).



**Figure 24.** Arrangement Branch I: a-parking space; b-landscaping [8]



a) b)  
**Figure 25.** Arrangement Branch II, Event hall: a-façade; b-lateral vision [8]



**Figure 26.** The lake between Branch II and Branch III [8]



**Figure 27.** The lake between Branch III and Branch IV [8]



**Figure 28.** Arranging a greenhouse with diversified flora on Branch III [8]



a) b)

**Figure 29.** Arranging the Branch V [8]  
a-children's playground; b-animal shelter

## 6. TECHNICAL-ECONOMIC CONSIDERATIONS ON THE PROPOSED SOLUTIONS

### 6.1. Forest recultivation of dumps

After achieving the objectives proposed in point 5.2, there are areas in the dump between 2.19 ha (Branch V) and 9.5 ha (Branch III) that will be recultivated in the forest.

Given that the dumps belonging to the Petrila mine are dumps from a mountainous region from the beech and spruce subzones, of mining origin, formed by sedimentary rocks (clays, marls) mixed with organic rocks (coals), the technical solution is proposed, regarding afforestation, the one shown in table 4.

**Table 4.** Technical solutions for dumps afforestation

Branch	Species used	Land preparation and consolidation	Improvement and afforestation procedures
0	1	2	3
I	Me; Mo.ag.; Mo; Mc; Tu	± N; Ma; ±T	± S; ± F; ±A; ±Pv; Pp
II	Mc; Tu; Pi; Sc; Me		
III	Tu; Mc; Mo; Gv		
IV	Pi; Mo.ag; Mo		
V	Sa; Sc; Pi; Mc		

Meaning of symbols:

Col.1. Me - birch; Mo.ag - silver spruce; Mo - spruce; Mc - brier; Tu - thuja; Pi - wild pine; Sc- acacia; Gv- hedge; Sa - willow.

Col. 2. N - leveling the land with the bulldozer; Ma - mobilization of the soil by plowing; T - terraces.

Col. 3. S- fertile soil deposited on the afforestation surface; F - fertilizer application; A - Amendment; Pv - topsoil; Pp - seedlings grown in ethylene bags

Note: The ± sign indicates whether or not to opt for that solution

The most suitable mixture is the one in bouquets of 50-100m<sup>2</sup> or in pure alternating strips 5-10m wide. In all cases, planting will be done in pits of 30x30x30cm at a distance between seedlings of 0.8-1.0m per row 1.5-2.5m between rows.

Table 5 provides an estimate of the total cost for afforestation of the 5 Branches of the Petrila mine dumps.

**Table 5.** The cost of afforesting the 5 Branches of the dumps from Petrila mine

Branch	Species used	Number of seedlings per hectare pcs./ha	Percentage of afforested %	Area to be afforested, ha	Number of seedlings required pcs.	The cost of seedling lei/seedling	Total cost lei/€
0	1	2	3	4	5=2x3x4	6	7=5x6
<b>I</b>	Birch	2500	30	7,5	5625	0,50	2812.5
	Silver spruce	3000	10		2250	2	4500
	Spruce	3000	20		4500	1,50	6750
	Brier	2500	20		3750	1	3750
	Thuja	2000	20		3000	5	15000
<b>II</b>	Brier	2500	30	8,5	6375	1	6375
	Thuja	2000	25		4250	5	21250
	Wild pin	2000	15		2550	3	7650
	Acacia	2500	10		2125	0,50	1062.5
	Birch	2500	20		4250	0,50	2125
<b>III</b>	Thuja	2000	30	9,5	5700	5	28500
	Brier	2500	30		7125	1	7125
	Spruce	3000	20		5700	1,50	8550

	Hedge	810000	20		1539000	0,20	307800
IV	Wild pin	2000	50	3,7	3700	3	11100
	Silver spruce	3000	25		2775	2	5550
	Spruce	3000	25		2775	1,50	4162.5
V	Willow	2500	30	2,19	1642,5	0,80	1314
	Acacia	2500	20		1095	0,50	547.5
	Wild pin	2000	20		876	3	2628
	Brier	2500	30		1642	1	1642
<b>Total cost of afforestation dumps from Petrila mine</b>							<b>450,194/ 90,000</b>

### 6.2. Scheduling of works

Tables 6 and 7 show the execution schedules of the works for the arrangement of the premises and dumps, according to the proposals presented in point 5. The times allocated to each work were estimated based on data obtained from companies with similar objectives. They, of course, have an indicative character, which can be established exactly only when there will be technical projects for each work.

**Table 6.** Execution schedule for mine yard

Name of works	Years and months of execution and monitoring												
	Year I				Year II				Year III				Years IV-VIII
	Jan.-Mar.	Apr.-Jun.	Jul.-Sept.	Oct.-Dec.	Jan.-Mar.	Apr.-Jun.	Jul.-Sept.	Oct.-Dec.	Jan.-Mar.	Apr.-Jun.	Jul.-Sept.	Oct.-Dec.	
Feasibility study													
Geotechnical study													
Decommissioning and demolition of premises													
Decommissioning of the railway													
Land clearing													
Purchase / transport / spreading soil													
Surface leveling													
Enclosure rehabilitation works													
Arrangement of the access road													
Monitoring													

**Table 7.** Execution schedule for dumps

Name of works	Years and months of execution and monitoring												
	Year I				Year II				Year III				Years IV-VIII
	Jan.-Mar.	Apr.-Jun.	Jul.-Sept.	Oct.-Dec.	Jan.-Mar.	Apr.-Jun.	Jul.-Sept.	Oct.-Dec.	Jan.-Mar.	Apr.-Jun.	Jul.-Sept.	Oct.-Dec.	

Pedological study	■												
Cleaning slopes and platformi		■	■										
Slope leveling / reduction works				■	■								
Construction of the access road						■	■						
Arrangement of the pedestrian sidewalk						■	■						
Realization of parking spaces								■					
Construction of precincts						■	■			■	■		
Chairlift arrangement						■	■						
Purchase / transport / spread of fertile soil								■					
Application of organic fertilizers								■					
Planting seedlings									■				
Sowing surfaces									■				
Putting into service											■		
Monitoring												■	

## 7. CONCLUSIONS

The main objective of the work is to create a landscape similar to the local one necessary for the development of an ecological tourism in the city of Petrila and also proposes the arrangement of the landscape in all its components: the natural landscape, the anthropic and cultural landscape.

From a social point of view, the purpose of the reclassification is to stop the decrease of the population by increasing the local jobs, developing several types of tourism valid throughout the year, a historical tourism of the industry and a tourism around the new designed space.

We proposed an arrangement plan for the premises: the center well, the qualification school, the rescue station, the mechanical workshop, the administrative building, the sorting station and the old preparation; this plan will raise the attractiveness



of the city of Petrila, increase the quality of the landscape and at the same time stimulate the cultural component.

We proposed solutions for the arrangement of tailings dumps as well as for the two lakes formed between dumps.

The species chosen for the arrangement of the Petrila mining perimeter are: Scots pine (*Pinus sylvestris*), birch (*Betula pendula*), acacia (*Robinia pseudacacia*), willow (*Salix babylonica*), silver spruce (*Picea Pungens*), rosehip (*Rosa canina*), spruce (*Picea Albies*) and Thuja (*Thuja*) these species have good resistance to anthropogenic aggression and minimal maintenance efforts.

We created 3D models of landscape and functional reintegration for the seven mining enclosures as well as for the geomorphological structures with the help of the Realtime Landscaping Architect 2 program.

The 3D models were created in order to provide a more objective description of the proposed solutions.

In the final part of the work we performed a technical-economic calculation to see what is the necessary investment for the landscaping of the Petrila mining perimeter.

## 8. REFERENCES

- [1]. Bold, O., Nimară., C. - Natural and anthropic landscape, (in Romanian) Universitas Publishing House, Petroșani 2016;
- [2]. Jujan, Ctin., Svoboda, T. - Petrila Mine 150 years of activity in industrial mining, (in Romanian) Cetate Deva 2009.
- [3]. Lazăr Maria - Rehabilitation of degraded lands, (in Romanian) Universitas Publishing House, Petroșani, 2010;
- [4]. Lazăr, Maria, Apostu, Isabela, Faur, F. - Methodology for assessing the environmental risk due to mining waste dumps sliding - Case study of Jiu Valley, (in Romanian), Carpathian Journal of Earth and Environmental Sciences, vol.10, nr.3/2015
- [5]. Nimară, C. - Research on the landscape reintegration of the anthropically affected areas within the Petrosani mining basin, doctoral thesis, (in Romanian) University of Petrosani, 2011
- [6]. Petrescu, V. - Protection of buildings with heritage status through modern methods of intervention, doctoral thesis, (in Romanian), Technical University of Constructions Bucharest, Bucharest 2014.
- [7]. Terleczi Andreea - Study on the landscaping of tailings dumps in the Jiu Valley, (in Romanian), Petroșani 2016.
- [8]. Terleczi Andreea- Solutions regarding the landscaping of the Petrila post-closure mining perimeter. Master's dissertation, (in Romanian), University of Petroșani, 2018
- [9]. \*\*\* Hunedoara Energy Complex
- [10]. \*\*\* S.N.I.M.V.J. Petrosani
- [11]. \*\*\* [www.land.copernicus.eu](http://www.land.copernicus.eu) (CLC 2012)
- [12]. \*\*\* [www.zhd.ro](http://www.zhd.ro)



## URBAN RECOVERY OF THE INDUSTRIAL BUILDINGS IN ROMANIA

Nimară Ciprian <sup>1</sup>

**Abstract:** *At the urban level, in Romania, deindustrialization has left behind huge derelict areas both inside the towns and in peripheral areas, coming into conflict with the neighborhood from an urban and social point of view. In most cases, the long presence of industrial sites in the immediate vicinity of residential areas is fixed in the collective memory of the place. However, industrial areas were harder for the city to absorb. In most cases, industry was the basis for the development of cities rich in useful mineral resources and with the industrial bankruptcy, the city gradually died. Behind them are wounded spaces, alveoli that digest the remaining constructions, until they disappear.*

**Keywords:** *urban recovery, landscape, industrial heritage, industry, Romania*

### 1. INTRODUCTION

Industrial regeneration is an important current issue and the opportunity to convert built funds in general, industrial objectives in particular and the reuse of abandoned sites is increasingly being pursued. But seeing the beauty in the architecture of industrial buildings is a critical point to be able to save them. The simple, open spaces of the factories, with the clear expressiveness of the construction materials and the structural elements, invite to an industrial restoration, preserving their identity and historical character even after their functional conversion.

A common practice today, globally, is the refurbishment of industrial buildings, many of them being transformed into cultural centers, museums, living spaces or offices. The opportunity that they discover in terms of urban regeneration is even to target a limited budget on the path of some key areas, with the means available.

Through the model of including the abandoned industrial territories in the daily circuit of the city, the balanced integration of these constructions in the urban fabric is achieved. Reduced at the site level, the conversion process is based on the ability to implement new, current features in an existing building and installation framework. It is about the co-presence of the surviving construction of an outdated function and the image of the new inserted function.

Disused industrial complexes are found in most Romanian cities, of different sizes, located differently from the city centers and their boundaries, developed over shorter or longer periods of time, with a greater or lesser number of constructions, in which only one kind of industry worked, or several worked. Industrial heritage is one of

---

<sup>1</sup> lecturer Ph.D., University of Petroșani, Mining Faculty, Department of Environmental Engineering and Geology (E-mail: ciprian.nimara@yahoo.com)

the richest resources in the urban environment, a resource that should be exploited, but at the same time, post-industrial areas in an urban setting are a problem for cities.

At the national level, since 1990, large industrial complexes, intensively developed during the communist period, have gradually ceased to function. They are located in or near central areas and although they have lost their ability to meet the initial requirements for various reasons (economic, location, non-compliance with current operating rules etc.) where the buildings are located in good condition, they could be refurbished and the regeneration of post-industrial areas could have an impact on the entire urban environment. If a city has an abandoned built environment, it must be rationally reused and although the industrial heritage is very vast, its immovable testimonies, especially industrial constructions, are those that can acquire new functions and bring benefits to the built environment, natural, inhabitants, investors, cities in their entirety. [6]

## **2. PRINCIPLES OF URBAN RECONVERSION**

Historic industrial sites, which were functional and structural urban nuclei, have today lost their key role in the city. Many of these industrial constructions have been abandoned and forgotten due to functional wear and tear and industrial decline. As a result, the architectural environment of these small industrial towns has lost its spatial integrity, soon becoming fragmentary and expressionless. Today, the architectural context of these cities is destroyed due to the lack of social awareness of the significance of industrial heritage in its signature and spatial structure. Industrial buildings that do not appear in the category of historical monuments, an integral part of the built heritage, are in a dangerous position, without having a privileged treatment, and are often considered parasitic on the urban space of which they are part. [7] Former industrial buildings have a special status. While the purpose for which they were built has disappeared, their usefulness seems to be completely out of date. Wrongly, the value they represent and the potential contribution to the enrichment of the technical heritage are overshadowed.

The rehabilitation and logical conversion of these spaces is an action that has become more and more widespread in recent decades, which contributes to mitigating the negative effects on the environment and safeguarding the built heritage. The orientation is towards the ways of reusing abandoned industrial buildings, capitalized either as residential or office spaces, or as cultural spaces: theaters, exhibition halls, museums or art centers. [1]

At the heart of these actions, however, is the reactivation of the memory of the place and the understanding of the potential for the reintegration of these entities into contemporary life.

In the case of abandoned industrial sites, previous experiences have led to the definition of five basic principles:

- *integration*, understanding of the space in which the studied area is located, as an area of a larger territory, characterized by social realities and an individual historical evolution;

- *multidisciplinary*, representing the multisectoral approach, from an economic, social and ecological point of view, without overestimating the role of urbanism;
- *coordination*. Political, economic and social factors must be involved in the process, seeking to reach a consensus;
- *flexibility*, the conversion process is a long one, which does not end with the launch of the project, but continues after this moment, with analysis of the results and interventions to improve them;
- *adaptability*, assuming that, once an action program has been established, it will be seen rather as a set of indications, of approach criteria. [5]

### 3. ADVANTAGES OF INDUSTRIAL BUILDINGS CONVERSION

Romania benefits from a vast and very varied industrial heritage, remarkable for Southeast Europe, which is neglected, abandoned and often demolished to make way for new constructions, thus losing both valuable architectural objects, as well as important parts of the history of the Romanian industry and defining elements for the history and identity of the urban areas of which they are part. Of course, the development of some industries had a major direct impact on the development of the city. Over time, industrial areas have been able to be an engine of urban development, taking on the dual role of spaces that serve urban needs, especially important from an economic point of view, and serviced spaces, which precisely through their existence and function, being generators of transformation and urban evolution.

This feedback relationship communicates a complex function of the industry. More than an economic instrument, the industrial ensemble has itself been a factor of development, a generator of urbanity, with a major impact on large areas at the territorial level. Thus, industrial areas are no longer just “urban accidents”, necessary presences (but at the same time undesirable) for the immediate neighborhood, but significant and current manifestations in the urban fabric. [3]

Their location becomes a pole of identity, able to determine, often, a definite character of the area and the factory is no longer imposed as a necessity, but manages to deliberately pronounce the configuration of the urban structure in general. On a large scale, the industrial site is perceived as a significant presence of the place. There is a permanent reciprocal conditioning, a dialogue between the industrial area and its direct neighborhood, but with amplified effects on the latter. Even if without monumental value, the factory acquires, through all its evocative aspects, heritage value. The impression of the place, much stronger than the strictly visual impression, is reflected in the preservation of the memory of a certain epoch, of a certain type of production, and especially the memory of a human existence. [8]

Functional conversion is a pragmatic method of building intervention. It must assess, following a broad criteria analysis, the potential for transformation of the existing one and identify the intervention methods that offer the best investment-quality ratio.

Urban quality depends more on the standard of maintenance and improvement of existing buildings than on the standard by which new buildings are built. Recycling means saving by reusing materials, and other kinds of savings, because new buildings generally involve the use of many materials such as glass, steel and aluminium, materials

that require high energy consumption to be produced. One way to improve a city is to save as much as possible from its past by adapting to the past. [5]

The conversion involves a lot of labour and, implicitly, the employment of many people, while the construction of a new building tends to be more economically and can be done, for the most part, with automated systems that consume more energy. At the same time, the old buildings are themselves an energy saving due to the massive construction system and the small windows.

The process of reusing an industrial building can present a number of advantages, but at the same time a series of technical, functional, financial and sometimes aesthetic difficulties, which vary depending on its nature and character, but also depending on the importance of higher or lower the criterion used to evaluate the final result. [4]

In general terms, the advantages of such process can be:

- the actual location: as an architectural program, a media library, public library or multimedia centre will be a fundamental part of integrated urban design and should become a polarizing centre. A better location improves the aspects of its influence on the community. Most heritage buildings are located in first class locations, such as the city centre, where land is either hard to reach or exorbitantly priced. However, there are also situations in which buildings with historical-industrial value are located outside the city, away from the hustle and bustle of the central area. This can be beneficial, provided that the future ensemble can act as a link between the city centre and the developing peripheral area;

- the symbolic value refers to the historical prestige of the construction through which it is viewed;

- architectural interest.

In addition, a successful reuse process may include the following positive features:

- rediscovering the identity of the municipality;
- conservation and maintenance of the building, but also of the entire industrial ensemble;

- improving the building by adapting it to a new function;

- revitalization and urban regeneration - in some cases the reuse of a single building can be the starting point for the renovation and maintenance of neighbouring areas;

#### **4. ISSUES OF INDUSTRIAL HERITAGE IN ROMANIA**

Intensive industrial development, often artificially encouraged politically, has given rise to huge new industrial sites (some of which have assimilated the older ones). Some of them were closed soon after 1989, causing major social problems and creating major destructured areas. The precarious economic situation of many of the companies that own industrial patrimony determines them either to abandon the patrimony whose maintenance is too expensive.

In addition to a certain lack of civic spirit, people are not attached to this subject, sometimes considering the "factory" a symbol of the restriction of personal freedom, of

subordination and hardly accepting to see it, for example, in illustrated postcards, along with consecrated monuments, such as the monasteries in northern Moldova. On the other hand, some former or current workers are beginning to become interested and sometimes decide to take a stand in favour of preserving industrial memory (as a group of former workers and engineers at the Reșița Steel Plant recently did to save the last Furnace from destruction). Some owners of industrial sites have also begun to understand the potential of old industrial buildings for the image of a traditional brand, even deciding to make small factory museums (as is the case of the Timișoara Brewery, producer of the Timișoreana brand Brewery, or the conversion of a former tram depot in Bucharest). [2]

At present, the legal protection of industrial heritage is ensured mainly by Law 182/2000 on the protection of movable cultural heritage and Law 422/2001 on the protection of historical monuments, as subsequently amended and supplemented. The two laws set out responsibilities and some facilities for property owners and those who want to invest in restoration. According to the second (recently amended and supplemented by Law 259/2006) the protected monuments in Romania are those registered in the List of Historical Monuments. Out of a total of 29425 monuments, ensembles and sites, a number of 716 are industrial or related to industrial development.

Although the first valuable steps were taken in the 80's, especially in the Banat area, through the efforts of some historians or archaeologists, industrial archaeology is still a new field and not very well defined in Romania. Research in the field is illustrated by some studies and articles on particular sites or developments. Extensive synthetic studies have not been published.

The precarious economic situation of many of the companies that own industrial patrimony determines them to either abandon the patrimony whose maintenance is too expensive (a sad case is that of the Assan Mill in Bucharest belonging to a company in liquidation, which left more or less accidentally, the monument is prey to destruction), or to “re-functionalize” it, with cheap and low-quality destructive investments. For convenience or lack of a forward-looking strategy, new constructions are preferred to more demanding interventions for restoration and restoration, valuable equipment is scrapped and destroyed due to refurbishment. These initiatives are all the more damaging to the large ensembles, divided by the hasty privatizations of the early 1990s, ensembles whose initial coherence will soon be decipherable. [2]

## **5. CONCLUSIONS**

The impact of reuse can go beyond the building itself, or the building complex involved, and can positively affect an entire neighbourhood or even an entire city and by destroying old industrial buildings to replace new buildings, traditions are virtually abandoned. The built environment must be preserved in such a way that it does not destroy or alter the history of a civilization.

For convenience or lack of a forward-looking strategy, new constructions of more demanding interventions for restoration and restoration are preferred, valuable equipment is scrapped and destroyed due to refurbishment. In Romania, these initiatives are all the more detrimental to the large ensembles, divided by the hasty privatizations of the early 90's, ensembles whose initial coherence will soon be decipherable.

Representing an impressive percentage of the surface of the cities and being now relatively close to the centres, the destructured industrial areas, former brand industries of the city, are seen as a huge urban reserve waiting for destinations.

## **6. REFERENCES**

- [1]. Berens, C., *Redeveloping Industrial Sites, A Guide for Architects, Planners and Developers*, John Wiley and Sons, Hoboken, New Jersey, USA, 2011;
- [2]. Iamandescu Irina, *Arheologia industrială - repere internaționale și contribuții românești*, UAUIM, București, 2005;
- [3]. Lichfield Dalia, *Urban regeneration for the 1990s*, London Planing Advisory Comitee, London, 1992;
- [4]. Nimară, C., Buia, Gr., *Elemente de urbanism și geografie urbană*, Editura Universitas, Petroșani, 2018;
- [5]. Palmer M, Neverson P, *Industrial archaeology, principles and practice*, Routlege, London, 2000;
- [6]. Roberts P., Sykes H., *Urban regeneration - a handbook*, Sage Publication Ltd., London, 2006;
- [7]. Stratton, M., *Industrial Buildings: Conservation and Regeneration*, Taylor and Francis, UK, 2000;
- [8]. \*\*\* *The Moscow Charter for the Industrial Heritage*, The International Committee for the Conservation of The Industrial Heritage (TICCIH), 2003;



## LAND SURFACE SUBSIDENCE UNDER THE INFLUENCE OF THE UNDERGROUND MINING OF THE OCNELE MARI ROCK SALT DEPOSIT

Marian Dacian-Paul<sup>1</sup>, Onica Ilie<sup>2</sup>

**Abstract:** *The rock salt deposit from Ocnele Mari-Cocenești, since 1996, has been exploited with small rooms and square pillars, at the level of horizons + 226 m and + 210 m, and now it is opening the horizon + 190 m. Since 2012, topographic monitoring of the subsidence of the land under the influence of underground voids has been carried out. Following the analysis of the data on subsidence and subsidence speeds, with the aid of some prognosis functions, the deformation of the land in the future was established, as a result of the exploitation of the horizons + 190 m (year 2030) and + 170 m (year 2040).*

**Keywords:** *rock salt, topographic landmarks, subsidence, subsidence speed, prognosis function*

### 1. INTRODUCTION

The rock salt deposit from Ocnele Mari - Cocenești is located in the region of the sub-Carpathian hills of Oltenia and belongs to the Getic Depression, with a hilly relief with heights between 300 and 360 m. This deposit was formed in a halogen basin consisting of a suite of bays and lagoons. The age of the deposit is Middle Badenian, and the sedimentary formations correspond to the Paleogene-Quaternary range. It has the shape of a lens, measuring approx. 7.5 km, after E-W and 3.5 km, in the N-S direction. The thickness of the sedimentary deposits in the roof varies between 20 m and 50 m, to the south, up to 700-800 m, in the northern side. The rock salt body has variable thicknesses, reaching a maximum value of 450 m, in the central part of the lens (Hirian & Georgescu, 2012; Marica, 2011).

The exploitation of this deposit has been known since Roman times, but a systematic underground mining began only in the 19th century, through bell shape type rooms. In 1959, the exploitation of rock salt in the central-western area of the deposit began, through dissolution wells (Hirean & Georgescu, 2012; Marica, 2011).

In 1996, the solid way exploitation of the Ocnele Mari - Cocenești deposit began, using the underground mining method with small rooms and square pillars (on a 30 x 30 m network), in a descending way. Until 2020, two levels were extracted, 16 m high, corresponding to the horizons +226 m and +210 m. The depth of location of the horizon +226 m is  $H=75-135$  m. In the west side, the dimensions of the rooms are 16 m wide and the pillars 14 x14 m, and in the east side, the rooms are 15 m, and the pillars 15x15 m. The ceiling between the two horizons is 8 m of thickness. At present,

---

<sup>1</sup> *Assoc.Prof.PhD.Eng.* University of Petroșani, Romania, dacianmarian@upet.ro

<sup>2</sup> *Prof.Habil.PhD.Eng.* University of Petroșani, Romania, onicai2004@yahoo.com

under a 12 m ceiling, the horizon +190 m is opening. This horizon is designed to be fully exploited with 15 m wide rooms and 15x15 m pillars.

After the extraction of a volume of rock salt from the deposit, the state of stresses and strains in the massif changes, having the effect of destroying the stability of the rock salt massif and the surrounding rocks. After the mining of the + 226 m level began, following the change of the natural state of stresses and strains, there were vertical deformations of the pillars, within their elastic limits, and reduced subsidence of the ceiling of the rooms, which were then transmitted to the crown pillar from the ridge of rock salt and further into the overlying rocks. Due to the low deformations of the pillars, their vertical displacements were taken over by the expansion/dilatancy capacity of the rock salt and the covering rocks, and the surface deformation was of the order of tens of millimeters, in a trough with a certain extension produced in 2001, when the exploitation began with the horizon +210 m. The exploitation of the rock salt deposit followed, level by level, until the complete extraction of the horizon +210 m, when the subsidence trough reached its maximum extension, for a total extraction height of the deposit of 24 m.

The subsidence of the land from the surface occurred cumulatively, by overlapping the effects generated by the deformation and vertical displacement of the pillars following the successive exploitation of the levels + 226m, then + 210m. Along with the cumulative vertical displacements of the overlapping pillars, there was an extension of the surface of the land affected by the underground mining, respectively of the subsidence trough (Fig.1).

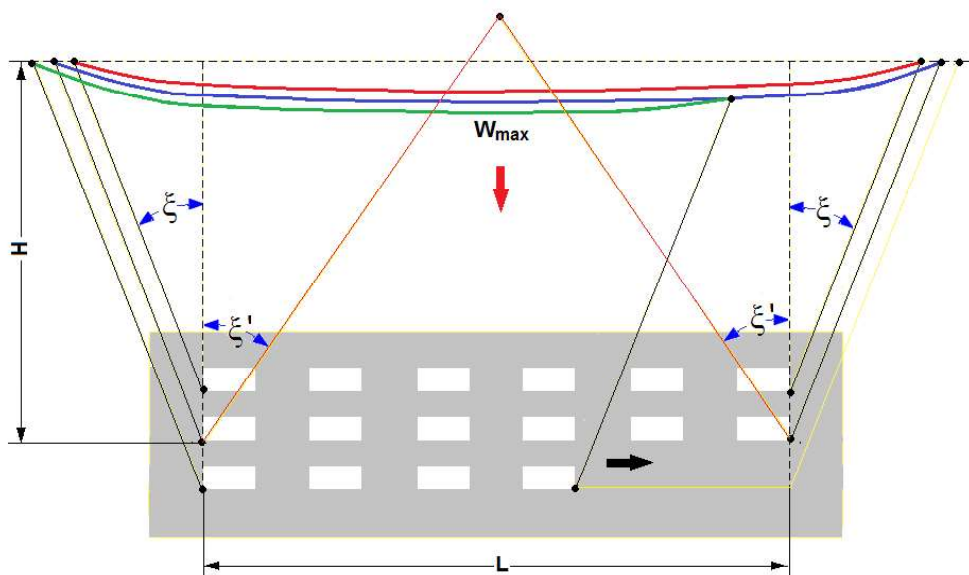

**Figure 1.** Development of the subsidence trough following the successive exploitation of the levels

The phenomenon described above is specific to continuous subsidence, which is also found in the exploitation of coal deposits and other deposits of sedimentary

origin. However, discontinuous subsidence, which occurs suddenly on the surface in the form of sinkholes, is less common in the case of solid exploitation of salt deposits and, in particular, in the presence of dissolution voids in the salt deposit (Brady & Brown, 2005).

Depending on the degree of damage to the land surface, the subsidence troughs can be subcritical, critical and supercritical. In the case of supercritical trough (see fig.1), the supercritical exploited space  $L$  is very wide in relation to the depth  $H$ , so that the lines delimiting the interior angles of influence  $\xi'$  intersect above the land surface. The maximum possible subsidence  $W_{max}$  is obtained at all points between the intersections of the surface and the lines of the interior angles of influence. In this case:

$$L / H > 2 \cdot tg\xi' \quad (1)$$

The main parameters that define the subsidence trough are the following: vertical displacement or subsidence, horizontal displacement, tilt, horizontal strain and vertical curvature (Singh, 1992; Marian, 2012).

Prediction/prognosis of land deformation is made by two categories of methods: empirical and phenomenological. The most used empirical methods for predicting subsidences are the following: graphicals, profile functions and influence functions (Singh, 1992; Marian, 2012).

The diagram in Fig. 2 shows the organization of information about the analysis of land deformations of the Ocelele Mari Salt Mine, inspired by a subsidence management scheme for two potassium mines in northeastern Spain, presented in the paper (Sanmiquel et al., 2018).

The organization of the topographic works at Ocelele Mari Saline, in terms of monitoring the subsidence, was carried out in a practical way, respecting the basic principles presented in this diagram.

The purpose of the topographic measurements on the relief of the land surface was to monitor the vertical displacements of several topographic landmarks, placed in the area of influence of underground mining excavations, and to present representative displacements for the perimeter of Ocelele Mari - Cocenești Salt Mine. In this sense, a series of fixed points were marked, with control coordinates, at which the points with time-varying coordinates were reported, for which the topographic office of the salt mine was carried out the actual monitoring of the movements of the land surface.

The information on the subsidence of the terrain, located in the area of influence of the salt mine, is based on the measured values in time of the coordinates of the monitored points, supported on the fixed coordinates of the points. From the difference of coordinates were obtained the relative values, defined in time, of the subsidences (vertical displacements) and subsidence speeds. This information on subsidence, corroborated with data and information on underground mining workings form a basis of results/data, presented in graphical and tabular form.

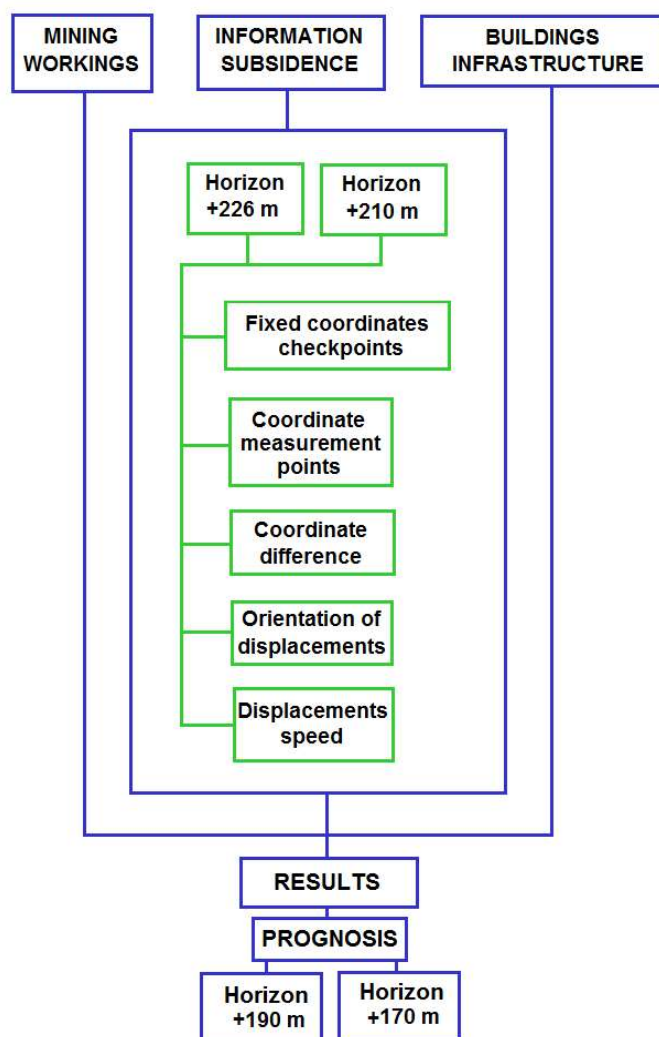

Figure 2. Surface subsidence analysis diagram of the Ocnele Mari Salt Mine (modified after Sanmiquel et al., 2018)

## 2. ANALYSIS OF THE DEFORMATION OF THE LAND SURFACE IN THE CONDITIONS OF THE EXPLOITATION OF THE ROCK SALT DEPOSIT FROM OCNELE MARI, AT THE LEVELS +226 M AND +210 M

In order to monitor the stability of the deposit and the land surface, starting with 2012, the surface topographic monitoring system was restored in the area of influence of the mine, a system consisting of 42 topographic landmarks installed in measuring points, distributed over the entire surface of the land, corresponding to the underground workings. On these landmarks, topographic leveling measurements are performed annually, in order to follow the movement of the land surface under the influence of the exploited underground space, calculating the level differences, the

speed of land movement and the subsidence gradient. The zero measurement was performed on 25.06.2012. We note that the monitoring of the subsidence trough was done only up to the limit of the mining field, the subsidence trough exceeding by about 100 -150 m, around it, the surface of the mining field.

Following the measurements, the differences in level  $\Delta Z$  were calculated, with subsidence and subsidence speed of the land surface being recorded.

The time interval from the zero measurement is 100 months for all landmarks, except the landmarks R2, R22, R36 and R37, which have a time interval from the zero measurement of 34 months. The time interval compared to the previous measurement, from 2019, is 11 months. The last measurement was made on 20.07.2020.

A first analysis of all the graphical and tabular information related to the measurements carried out in 2020, both in terms of subsidence and subsidence speeds, shows that the highest values of these parameters are in the eastern part of the mining field and approximately along the northern boundary of the mining field. For the landmarks located in these areas, higher  $Z$  elevations of the land can be observed, respectively higher depths of the exploitation horizons than the surface and implicitly some more important values of the gravitational stresses. Moreover, with regard to the eastern area of the mining field, the main factor that contributed to the emergence of subsidence and higher subsidence speeds, compared to the rest of the mining field, is the higher volume of underground voids, respectively the volume of reserves extracted from this area and the larger size of the mining field.

The highest values of the subsidences ranging between 100 and 125 mm and are represented by the landmarks R9, R13, R14, R16, R19, R27, R32 and R36 (fig.3 and 4) which are located towards the northern limit of the mining field, culminating with landmarks R38 and R39, from the east, with subsidences of 140 mm and 177 mm respectively. The subsidence speeds corresponding to these landmarks are 1-1.2 mm / month, with a maximum of over 1.8 mm/month at landmarks R39 and R42 (fig. 5 and 6).

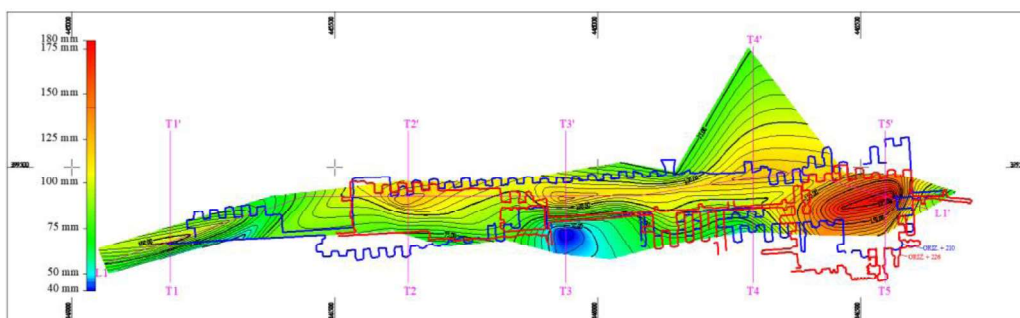

**Figure 3.** Subsidence measured in 2020 - scalar representation in the plan

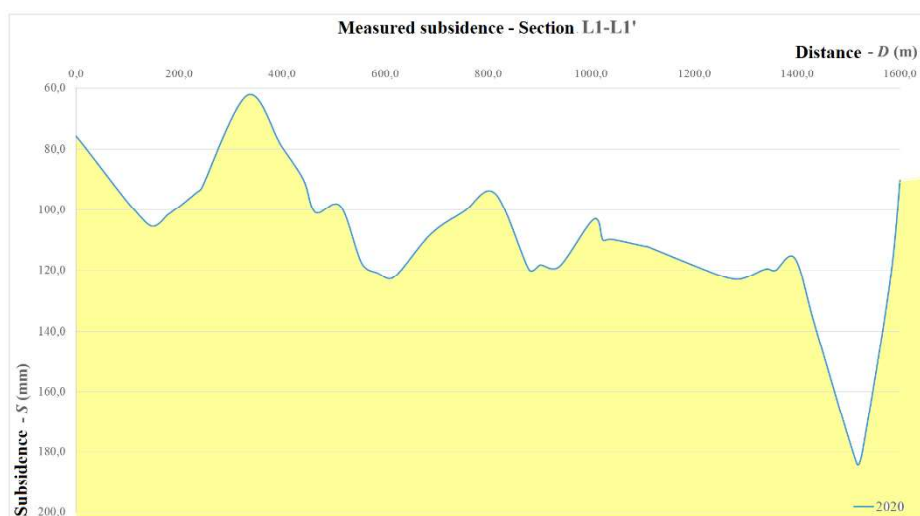

Figure 4. Subsidence measured in 2020 - E-W longitudinal section

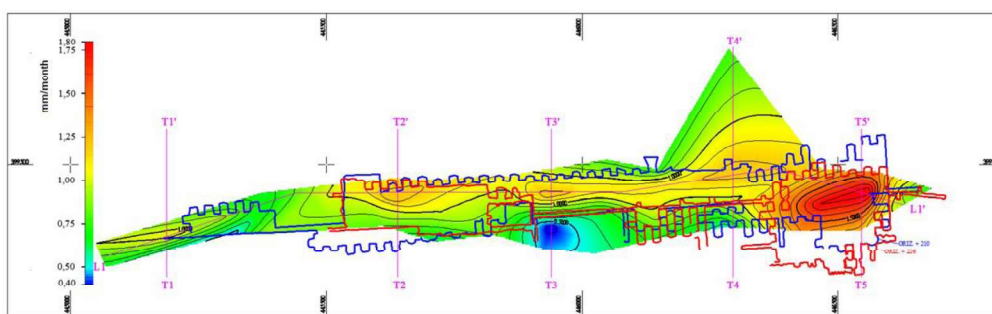

Figure 5. Subsidence speed measured for 2020 - scalar representation in the plan

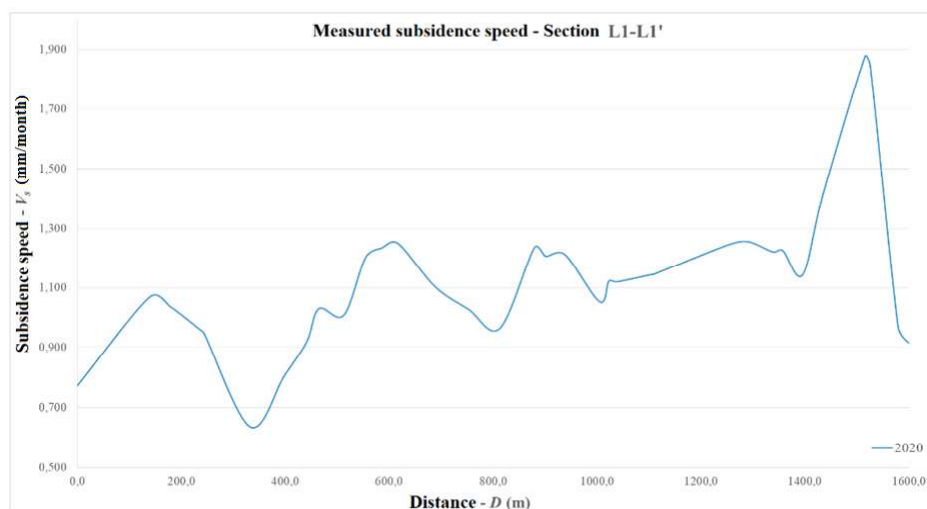

Figure 6. Subsidence speed measured for 2020— Longitudinal section E-W

### 3. PROGNOSIS OF LAND DISPLACEMENT FOLLOWING FUTURE EXPLOITATION OF THE LEVELS + 190M AND + 170M

In addition to the interpretation of the database, which contains the evolution in time of the coordinates of the landmarks on the surface of the Ocnele Mari Salt Mine, it is necessary that, starting from the analysis of the land subsidence in time by 2020, to make a prognosis/ prediction of the land movement, at least at the end of the exploitation of the horizons +190m (year 2030) and +170m (year 2040). In order to achieve the above-mentioned objective, an approximation was made of the evolution of the subsidence of each landmark over time ( $i=1 \div 42$ ), with the help of power and logarithmic prognosis functions, with the general form:

$$S_{(t)i} = a_i \cdot t^{b_i} \quad \text{și} \quad S_{(t)i} = c_i \cdot \ln(t) - d_i \quad (2)$$

where:

$i$  represents the landmark number;  $S_{(t)i}$  - subsidence in time of the landmark  $i$ ;

$a_i, b_i, c_i$  și  $d_i$  - the regression coefficients of the power type function, respectively of the logarithmic function, for each landmark  $i$ .

The approximation functions determined for each landmark, for 8 successive annual measurements, between 2013 and 2020, respectively for a monitoring period of 98 months, are presented in table no.1. The determination coefficients  $R^2$  of the approximation functions are relatively high for most landmarks ( $R^2 = 0.7 - 0.992$ ), which confirms that the degree of accuracy of the prognosis functions is relatively good.

**Table 1.** Table with prognosis functions for vertical displacement of the landmarks

Power type prognosis function $S_{(t)i} = a_i \cdot t^{b_i}$						Logarithmic prognosis function $S_{(t)i} = c_i \cdot \ln(t) - d_i$					
Land mark	Regression coefficient		$R^2$	Land mark	Regression coefficient		$R^2$	Land mark	Regression coefficient		$R^2$
	$a_i$	$b_i$			$a_i$	$b_i$			$c_i$	$d_i$	
<b>R1</b>	0.5228	1.0045	0.966	<b>R21</b>	1.8105	0.817	0.839	<b>R2</b>	58.671	174.71	0.895
<b>R3</b>	10.774	0.4499	0.433	<b>R22</b>	0.0257	1.374	0.800	<b>R30</b>	29.871	78.659	0.675
<b>R4</b>	5.2473	0.5993	0.766	<b>R23</b>	14.690	0.4603	0.841	<b>R31</b>	45.308	123.2	0.938
<b>R5</b>	0.7096	0.8711	0.738	<b>R24</b>	0.117	1.1584	0.354	<b>R32</b>	46.951	117.94	0.857
<b>R6</b>	3.0174	0.6391	0.842	<b>R25</b>	0.7693	0.8908	0.733	<b>R35</b>	36.882	106.8	0.635
<b>R7</b>	1.0781	0.8481	0.909	<b>R26</b>	0.5778	1.0849	0.823	<b>R36</b>	69.388	202.32	0.955
<b>R8</b>	5.5373	0.5545	0.569	<b>R27</b>	3.7406	0.7311	0.976	<b>R39</b>	87.737	253.41	0.830
<b>R9</b>	5.4245	0.6442	0.935	<b>R28</b>	0.6974	0.9897	0.827	<b>R40</b>	76.681	254.58	0.721
<b>R13</b>	4.4670	0.6961	0.922	<b>R29</b>	6.3408	0.4289	0.759	<b>R42</b>	82.46	213.13	0.932
<b>R14</b>	2.7065	0.8213	0.903	<b>R33</b>	0.5169	1.0296	0.941	<b>R44</b>	39.172	96.468	0.921
<b>R15</b>	1.6905	0.8280	0.992	<b>R34</b>	1.0687	0.7224	0.522				
<b>R16</b>	1.3443	0.9693	0.927	<b>R37</b>	9.0139	0.4203	0.710				
<b>R17</b>	3.7614	0.6805	0.817	<b>R38</b>	2.9082	0.8204	0.907				
<b>R18</b>	1.7871	0.7228	0.587	<b>R41</b>	1.8853	0.9118	0.963				
<b>R19</b>	1.9233	0.8439	0.857	<b>R43</b>	4.601	0.7498	0.969				
<b>R20</b>	0.9350	0.9864	0.924	<b>R45</b>	6.7763	0.5341	0.579				

The calculation of the predicted values of subsidence and subsidence speeds, at the level of each landmark, using the prognosis functions (2), represented tabularly and graphically (scalar representation in plan, through representative cross sections N-S and longitudinal E-V) was performed for the following scenarios:

a) if the exploitation would have stopped in 2020, when the reserves of rock salt from the horizon + 210 m were fully extracted. For this situation, the prediction calculations of subsidence and subsidence speeds were performed after annual intervals, until 2040;

b) at the end of the full exploitation of the reserves from the horizon + 190m - approximately the year 2030;

c) for the year 2040, when it is assumed that the reserves from the horizon +170 m will be fully exploited.

Although the scenario (a) is not realistic and the exploitation of the Ocele Mari rock salt deposit will continue at least at the horizon level +190m, these calculations were necessary (at least to obtain the prognosis values for 2030 and 2040), which are the calculation basis for scenarios (b) and (c).

For a better analysis of subsidences and subsidence speeds, measured and predicted, the distribution of these parameters was represented in the plan, in scalar form, by interpolating the values stored in the table, accompanied by a vertical longitudinal section L1-L1' (in the E-W direction) and five representative T1-T1' ÷ T5-T5' cross-sections (N-S direction). Also, in order to be able to correlate these values with the exploited areas, on these graphical representations in the plan the exploitation limits of the mining field were marked.

In case (a), if the mining activity were to cease now, analyzing the trend of increasing the predicted subsidence, by longitudinal profile, for the distance  $D=1,516$  m, a maximum subsidence is highlighted in the eastern part of the mining field; if in 2025 this subsidence is expected to be 271mm, in 2040 it will be 487mm, and in 2070, 851mm.

Correspondingly, for  $D=1,516$ m, subsidence speeds of 1.725mm/month are predicted in 2025, which will attenuate to 1.44mm/month in 2040, tending to the value of 1.218mm/month in 2070.

These values of subsidence and subsidence speeds demonstrate a stabilization of the subsidence phenomenon, if the rock salt mining will end with the horizon +210 m. As the exploitation of the deposit continues in depth, starting with the horizon +190 m, the subsidence phenomenon will be amplified with the expansion of the mining field, until the reserves of this horizon are exploited. Therefore the measured values must be adjusted by a coefficient, which takes into account the volume of reserves exploited, which for case (b) has the value  $k_{+190}=1.71$ .

Then, each new horizon exploited in depth will contribute to the amplification of the phenomenon of deformation of the land surface, depending on the volume of exploited reserves. Thus, if we take into account the full exploitation of the horizon +170 m, then the value of the amplification coefficient of the subsidence phenomenon for this new exploited horizon is  $k_{+170}=2.42$ .

The volume of extracted reserves (voids on each level) is:  $V_{+226} = 495,833 \text{ m}^3$ ;  $V_{+210} = 1,052,778 \text{ m}^3$ ;  $V_{+190} \cong V_{+170} = 1,100,000 \text{ m}^3$ . So, the reserves from the horizon.



+190 m and those from the horizon +170 m, at an average production capacity of approx. 110,000 -120,000 tons / year, will be exploited each in about 9-10 years.

In order to obtain the prediction of the subsidence and the subsidence speed of the land produced at the end of the extraction of the horizon +190 m, respectively +170 m, the values of subsidence and subsidence speeds will be multiplied on the predicted date in case (a), for each landmark, respectively for 2030, for horizon +190 m and for the year 2040, for horizon +170 m, with the coefficient  $k_{+190} = 1.71$ , respectively  $k_{+170} = 2.42$ .

Analyzing the predicted values, thus calculated, it can be seen that the maximum subsidence, in the area near the surface close to landmarks R39 and R42, in 2030 (after the exploitation of horizon +190 m) will be approx. 550-600 mm, for an average subsidence speed of 2.5-2.7 mm/month, and in 2040 (after full mining of the horizon +170 m) will be approx. 1,100-1,200 mm, for an average subsidence speed of 3.2-3.5 mm/month.

The predicted subsidences on landmarks were represented scalar in the plan, for the year 2030 (fig.7), for the year 2040 (fig.8) and in a longitudinal section E-W (fig.9) with the predicted subsidences in the years 2030 and 2040, compared with those measured in 2020.

The predicted subsidence speeds were adequately represented in figures 10 and 11, and compared to those measured, in the E-W longitudinal section (fig. 12).

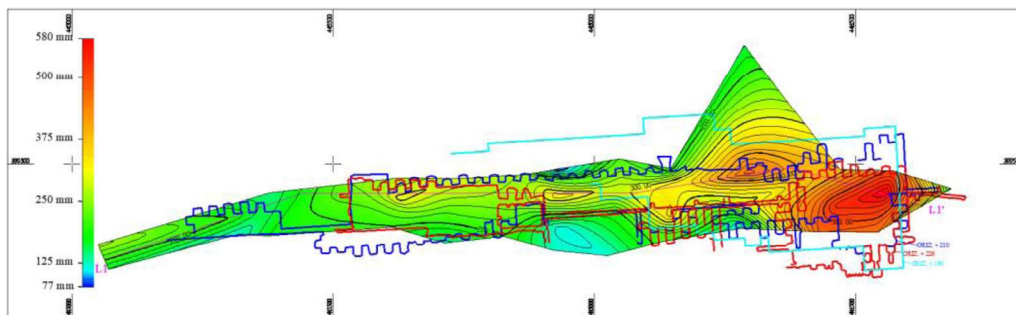

**Figure 7.** Predicted subsidence for 2030 (after mining of horizon +190 m) - scalar representation in plan

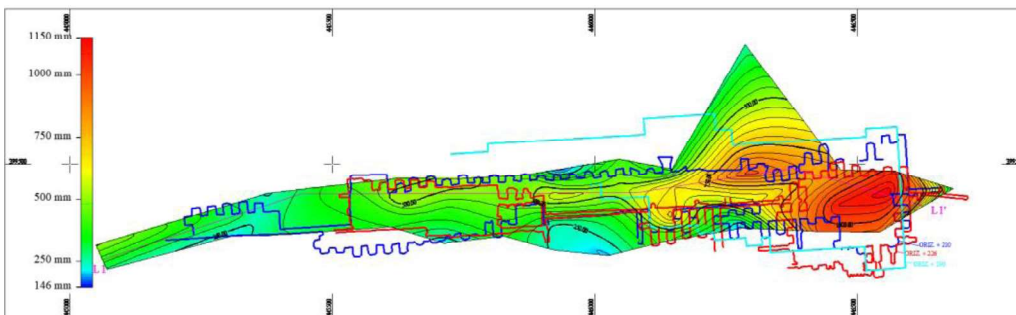

**Figure 8.** Predicted subsidence for 2040 (after mining of horizon +170 m) - scalar representation in plan

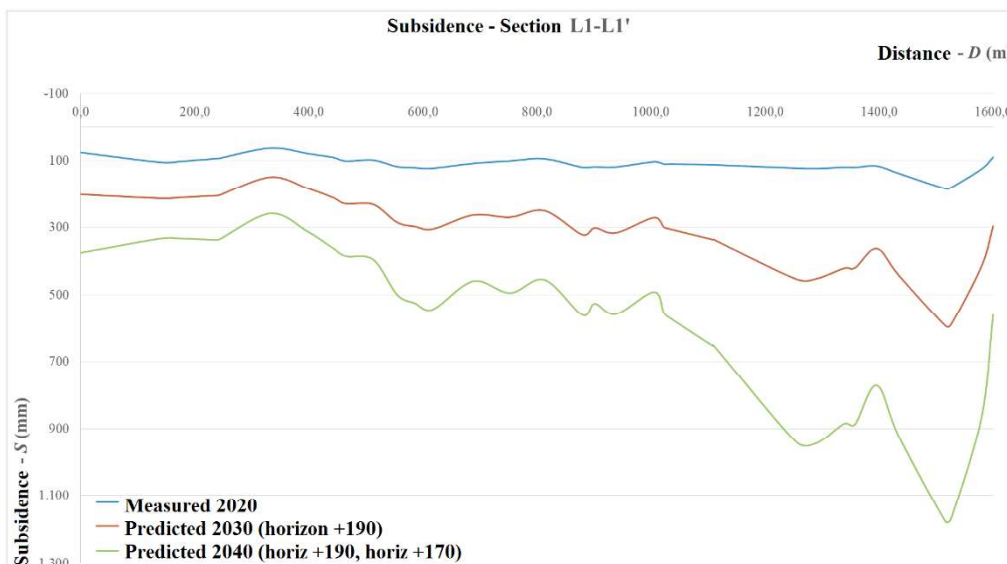

Figure 9. Subsidence measured for 2020 and predicted for 2030 and 2040 - E-W longitudinal section

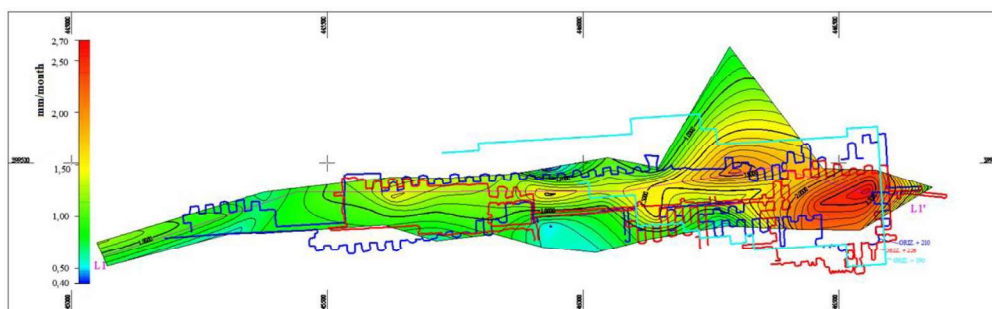

Figure 10. Predicted subsidence speed for 2030 (after mining of horizon +190 m) - scalar representation in the plan

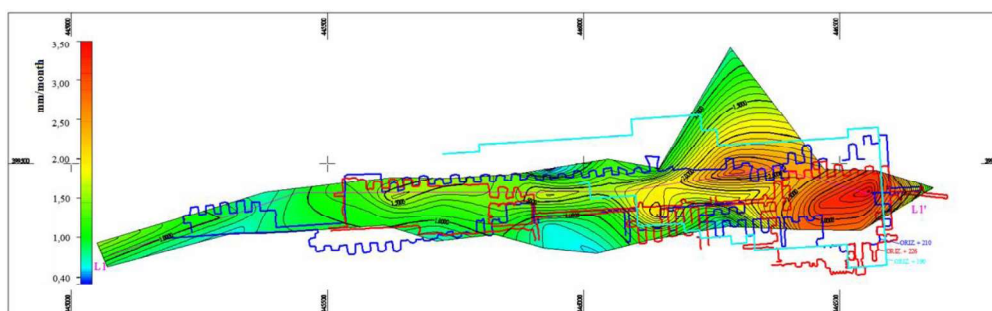
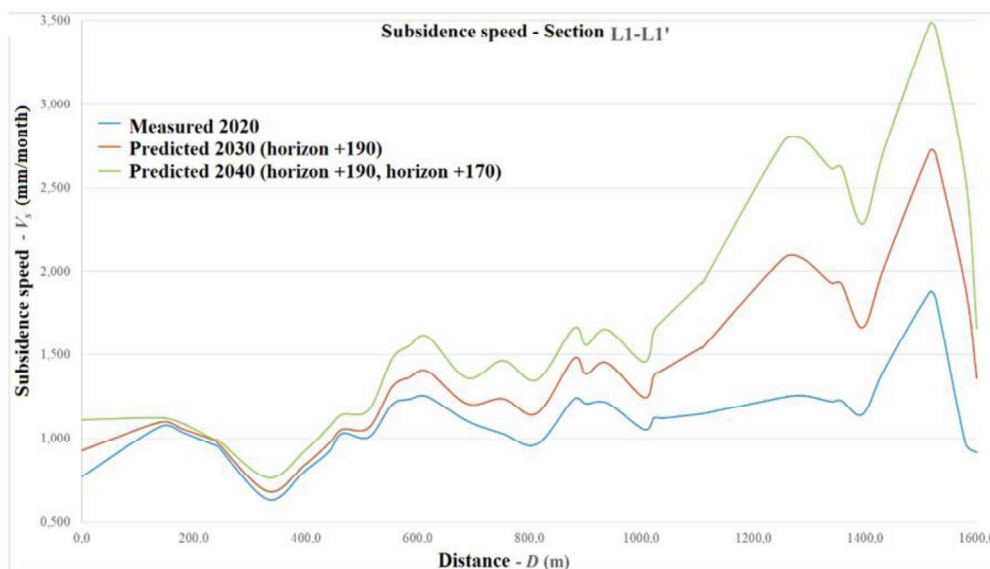

Figure 11. Predicted subsidence speed - year 2040 (after mining of horizon +170 m) - scalar representation in the plan



**Figure 12.** Subsidence speeds measured for 2020 and predicted for 2030 and 2040  
- Longitudinal section E-W

### 3. CONCLUSIONS

The solid way mining of the rock salt deposit from Ocnele Mari - Cocenești started in 1996, through the horizons + 226 m and + 210 m. The mining method used is with small rooms and square pillars. From 2020 it is opening horizon 190 m, and the exploitation will be completed in approx. the year 2030, when the exploitation will start horizon. +170m.

Since 2012, the subsidence of the land surface has been monitored by annual topographic measurements, performed on 42 surface landmarks, inside the mining field.

In 2020, the highest values of subsidence are between 100 and 125 mm and are represented by the landmarks located towards the northern limit of the mining field, culminating with the landmarks from the east, with subsidences of 140 mm and 177 mm respectively. The subsidence speeds corresponding to these landmarks are 1-1.2mm/month, with a maximum of over 1.8 mm/month, at the level of the eastern landmarks.

As the topographic landmarks did not cover the entire surface of the subsidence trough, it is proposed that, in the future, the monitoring of land deformation be extended, around the contour of the exploitation perimeter, by another 100 -150 m, depending on the depth and diving angles. Also, to make the works more efficient, it is recommended to monitor the land surface with the help of aerial photogrammetry and laser scanning techniques.

Based on the information obtained, regarding subsidence and subsidence speeds, power and logarithmic prognosis functions were developed for each landmark. These approximation functions, together with some coefficients of amplification of the

deformation phenomenon, depending on the volume of the extracted reserves ( $k_{+190} = 1.71$  and  $k_{+170} = 2.42$ ), were the basis for the elaboration of the annual maps with the subsidence of the land and subsidence speed, predicted in time.

Analyzing the predicted values, thus calculated, it can be seen that the maximum subsidence in 2030 (after the exploitation of horizon +190m) will be approx. 550-600mm, for an average subsidence speed of 2.5-2.7 mm/month, and in 2040 (after full mining of the horizon +170 m) will be approx. 1,100-1,200 mm, for an average subsidence speed of 3.2-3.5 mm/month.

#### **4. REFERENCES**

- [1]. Brady, B.G.H., Brown, E.T. (2005), Rock Mechanics for underground mining, Third edition, Kluwer Academic Publishers, New York, Springer Science + Business Media, Inc.
- [2]. Hirian, C., Georgescu, M. (2012), Stability of old salt salines in Romania-condition of their use for various fields (in Romanian), Universitas Publishing House, 2nd Edition.
- [3]. Marian, D.P. (2012), Topographic monitoring and analysis of the deformation of the land surface affected by underground exploitation, Universitas Publishing House, Petroșani.
- [4]. Marica, D. (2011), Study of the stability of mining excavations at the Ocnele Mari salt mine in order to increase the degree of work safety (in Romanian), PhD Thesis, University of Petroșani.
- [5]. Sanmiquel, L., Bascompta, M., Carla Vintró, C., Yubero, T. (2018), Subsidence Management System for Underground Mining, Minerals, 8, 243.
- [6]. Singh, M.M. (1992) Mine subsidence, Chapter.10.6., SME Mining Engineering Handbook, 2nd Edition, Volume 1, Senior Editor, Howard L. Hartman Published by Society for Mining, Metallurgy, and Exploration, Inc. Littleton, Colorado, pp.938-971.

## THE INFLUENCE OF UNDERGROUND MINING ON THE STABILITY OF LAND AT JIU VALLEY MINE SURFACE

Roman Liliana <sup>1</sup>

**Abstract:** *The paper is part of a larger research on the effects of mining in Jiu Valley on the environment, the state of the land at the surface of the mines being a component part of it. It includes a synthetic theoretical part, known and accepted in the literature, regarding the study of subsidence phenomena that may occur following the underground mining of a deposit and research conducted over many years in the case of eight mining perimeters in the Mining Basin of Jiu Valley, using the results highlighted in numerous studies and doctoral theses developed to study the phenomenon of subsidence, focusing on the effects of underground mining on surface objectives without detailing the methods of tracking subsidence phenomena applied and known in the literature.*

**Keywords:** *Jiu Valley, subsidence, effects on the environment*

### 1. INTRODUCTION

The underground mining of a deposit inevitably leads to the deformation of the land surface as well as to the destruction of the objectives located in the area of influence of the exploitation.

Consequently, the surface land will be affected by underground mining, causing the phenomenon of subsidence.

With the pit coal working in Jiu Valley, there was a need to assess the stability of some constructions and analyze the condition of the surface lands affected by the influence of underground exploitation.

In the area of Jiu Valley mining basin, over 20 ha of land can no longer be used for construction or agriculture because, due to the collapse of the land from the surface, the groundwater level was lowered, which caused desertification and extinction of local flora and fauna. The fractured and unstable land affected almost 70 individual households and, in some cases, caused the destruction of a large number of houses and the community center of Dâlja Mare [2].

There were other incidents: the displacement of the auxiliary tower no.1 from Livezeni mine, which led to its abandonment; partial destruction of the ventilation shaft no.2 Petrila, which led to its deallocating; the presence in the area of influence of the Lonea mine of the metal pillars of the Valea Arsului cable car which led to the abandonment of the project; the presence in the area of influence of the Lonea mine of 80 houses, several of which had to be demolished [2].

---

<sup>1</sup> Student Ph.D. Eng. University of Petroșani

Depending on the geological and mining conditions, the coal mining operations in the Jiu Valley led to the submergence of the surface land (vertical displacements) at levels ranging from 1 meter (in the case of coal seams with reduced thickness and inclination) and tens of meters (in the case of thick and very sloping coal seams) as is the case from Lonea mine and Lupeni mine [2].

In the case of the mines from Jiu Valley, the monitoring of the surface subsidence phenomenon as a result of underground mining was done by classical topographic methods, the determination of the height of the points forming the monitoring station is done by topographic methods, namely middle geometric leveling and/or trigonometric leveling.

Because these methods make it less possible to predict the effects of underground mining on the surface of the field, researchers have recently been using methods to predict sinking phenomena, such as mathematical-analytical methods (empirical or model-based).

This paper is part of a larger research on the effects of mining in the Jiu Valley on the environment, the state of the land at the surface of the mines being a component part of it.

It includes a synthetic theoretical part, known and accepted in the literature, on the study of subsidence phenomena that may occur from the underground exploitation of a deposit and a part of analysis of these phenomena that occurred in the mining perimeters of Jiu Valley putting -the emphasis is on the effects produced by the underground exploitation on the surface objectives without detailing the methods of following the subsidence phenomena applied and known in the specialized literature

Given the complex and long-term nature of the land surface deformation processes under the influence of underground mining in the case of the mines in the Jiu Valley Mining Basin, the paper briefly presents the research conducted over many years in eight perimeters using the results highlighted in numerous studies and doctoral theses developed to study the phenomenon

Given the complex and long-term nature of the land surface deformation processes under the influence of underground mining in the case of the mines in Jiu Valley Mining Basin, the paper briefly presents the research conducted over many years in eight perimeters using the results highlighted in numerous studies and doctoral theses developed to study the phenomenon of subsidence.

## **2. THEORETICAL CONSIDERATIONS REGARDING THE DEFORMATION OF THE LAND SURFACE FROM THE SURFACE UNDER THE INFLUENCE OF UNDERGROUND MINING**

The underground mining of a deposit inevitably leads to the deformation of the land surface as well as to the destruction of the objectives located in the area of influence of the exploitation.

The most important factors on which the movement of the surface depends are: the dimensions of the gap resulting from the exploitation, the depth of exploitation, the thickness and inclination of the useful mineral seam, the mining method and the applied technology, the pressure direction, the geomechanical characteristics of the rocks. and

tectonics of the deposit, duration of exploitation, etc. Most of the times, following the movement of the rock mass, on the surface of the land, a cavity called subsidence bed will appear, the main parameters of which, defined in the specialized literature by several authors [12], are (fig.1 and 2):

- subsidence angles:  $\beta_s$  downstream,  $\gamma_s$  upstream,  $\delta_s$  in the direction;
- breaking angles:  $\beta_r$ ,  $\gamma_r$ ,  $\delta_r$ ;
- subsidence or vertical displacement:  $W$ , in mm;
- horizontal displacement:  $U$ , in mm;
- specific horizontal deformation:  $\varepsilon$ , in mm/m;
- inclination:  $T$ , in mm/m;
- curvature:  $K$ , in  $m^{-1}$ .

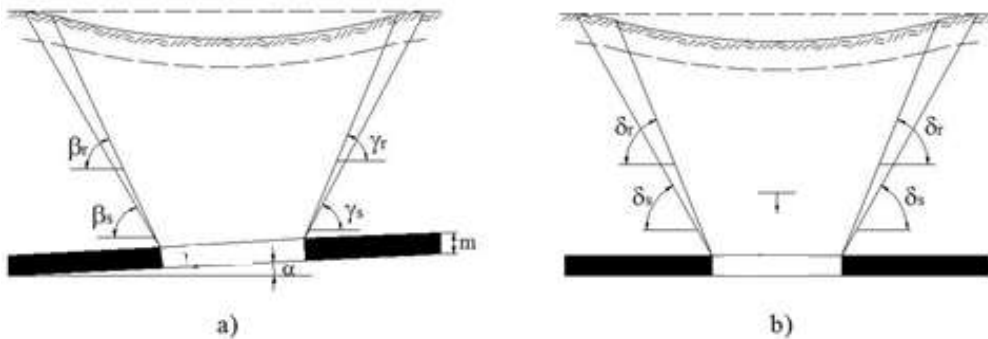

**Figure 1.** Representation of subsidence and breaking angles [12]:  
a) on inclination; b) on the direction

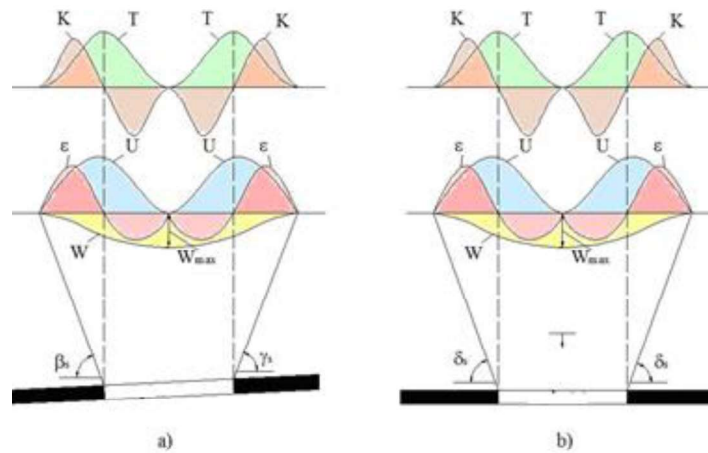

**Figure 2.** Displacement and deformation curves of the ground surface for horizontal seams and of low inclination: a) on inclination; b) in the direction [12]

$W$  - curve of vertical displacements (subsidence bed);  $U$  - horizontal displacement curve;  $\varepsilon$  - curve of specific horizontal deformations;  $T$  - the slope curve of subsidence bed ;  $K$  - the curve of the curvature of subsidence bed.

In the case of the working methods currently used in Jiu Valley, the rocks from the roof of the working seam collapse with the advancement of the coal face (fig.3), this process being the most destructive process of directing the mining pressure.

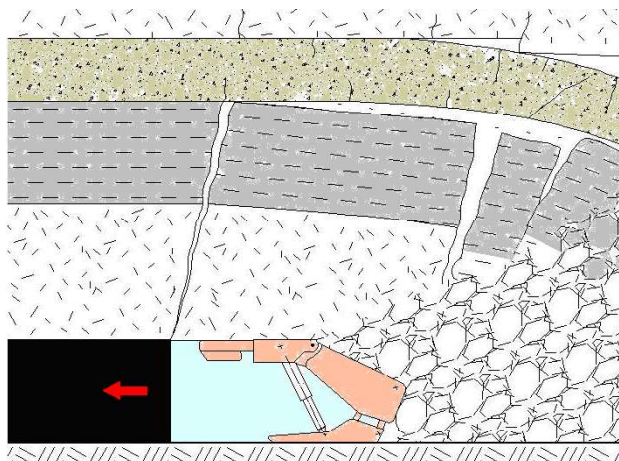

**Figure 3.** Behavior of the rock mass above and behind the coal face [12]

The main methods of studying the problems related to the movement and deformation of the land from the surface under the influence of underground workings can be divided into two groups, namely [12]:

- *Topographic methods used to track the movement of the land surface*

These were the first methods that highlighted the movement of the surface as a result of underground exploitation and are the most used methods to track the subsidence phenomenon.

They consist in placing on the surface of the land, in the area of influence of the exploited space, some topographic alignments. These alignments consist of topographic points, materialized on the surface of the land by metal poles.

Direct topographic measurements determine the parameters  $W$  (subsidence) and  $U$  (horizontal displacement), and the other parameters are determined indirectly by calculation.

Due to the current technological level, the methods for monitoring the subsidence phenomenon have been improved, thus reducing the time to perform the measurements. Of these the most used, largely only worldwide, in pursuing the phenomenon of subsidence are:

- Monitoring the subsidence phenomenon with the help of GPS technology;
- Monitoring the subsidence phenomenon through photogrammetry;
- Use of interferometry to monitor ground diving.

- *Mathematical-analytical methods used in forecasting*

These methods consist in adopting forecast calculation relations of the main parameters that define the subsidence bed. For this, one of the calculation methods that have been developed for geological-mining conditions similar to the conditions of the deposit to be exploited is applied, a method that has been verified and led to satisfactory



results. In order to know the phenomenon, the formation of the diving bed and the construction of the mathematical model, one must consider the real bed that conforms to the conditions accepted by the given theory and describes the diving process.

Currently, in the literature there are a multitude of methodologies for calculating the prediction of these parameters, the results of which have been confirmed in practice: *empirical prediction methods, graphical prediction methods, methods of profile functions, methods of influence functions, methods forecasting based on models (physical, stochastic), numerical methods (continuous differential-finite elements and finite differences-, continuous integrated- boundary elements-, discontinuous- distinct elements- and hybrid methods)* [12].

### **3. SUBSIDENCE PHENOMENA IN THE MINING PERIMETERS OF JIU VALLEY**

#### ***3.1. General considerations regarding the monitoring of subsidence phenomena in Jiu Valley***

In the case of the mines from the Jiu Valley, the classical topographic methods were used to highlight the displacements and deformations of the land surface, which require the design and materialization of tracking stations consisting of transverse and directional alignments to the direction of the deposit or alignment networks [14]. The shape and type of alignments or topographic tracking networks were chosen according to the purpose and local conditions regarding the morphology of the surface land.

The networks or alignments located above the mining fields form a station for tracking the movement and deformation of the surface.

Follow-up alignments include: main connecting marks, supporting marks (stable or end) and working marks (mobile).

The main connecting landmarks are topographic points that are part of the triangulation network of the mine or basin. They must be present throughout the measurements and must be stable.

The supporting landmarks (stable or end) shall materialize for each alignment and shall be located outside the areas of influence of the operation, in some cases belonging to the local triangulation network of the mine.

Work or mobile landmarks are located at certain distances from each other, depending on the depth of operation, between the end landmarks.

The topographic landmarks were made of railway rail with a length of 1.1-1.2m, to be below the frost limit. The distance between the landmarks was taken according to the depth of the deposit (seams) from the land surface ( $H$ ):  $\sqrt{H}$ .

With the help of topographic methods the absolute and differential movements of the surface for certain given conditions are determined.

In the mining perimeters of Jiu Valley, direct topographic methods were applied using the tracking alignments with one or two stable ends.

These methods consisted in measuring the absolute movements of the parts, which resulted in the direct measurement of the distances between the parts with the help

of 50m roulette stretched at the ends with weights of 10daN and in determining their dimensions by high precision leveling using Koni 007 levels and special rod of invar.

To determine the parameters of displacement and deformation, tracking stations were placed in each mining field (mine).

In the following will be presented the results of the measurements performed over time in eight mining perimeters Jiu Valley mining basin (fig.4), where tracking stations were located.

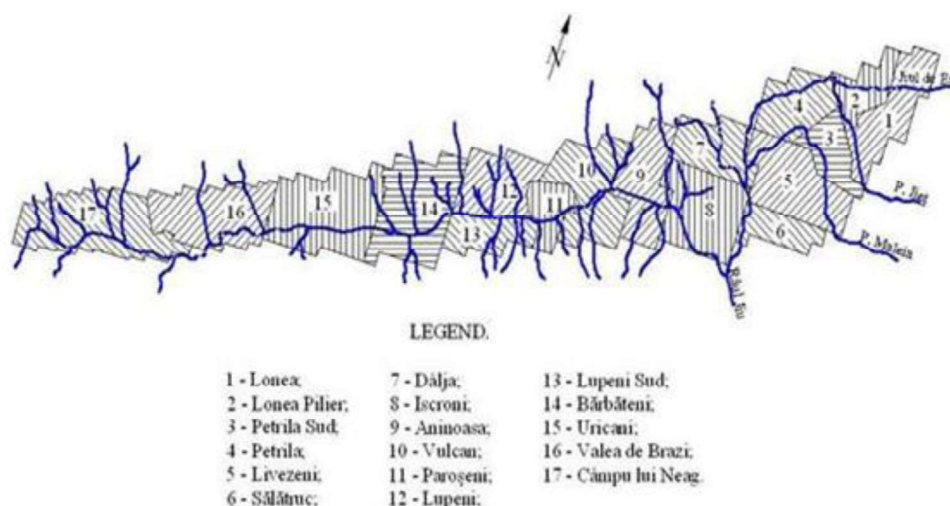

Figure 4. Mining perimeters within the Jiu Valley mining basin

The configuration of the seams in the mining basin of Jiu Valley is presented in figure 5.

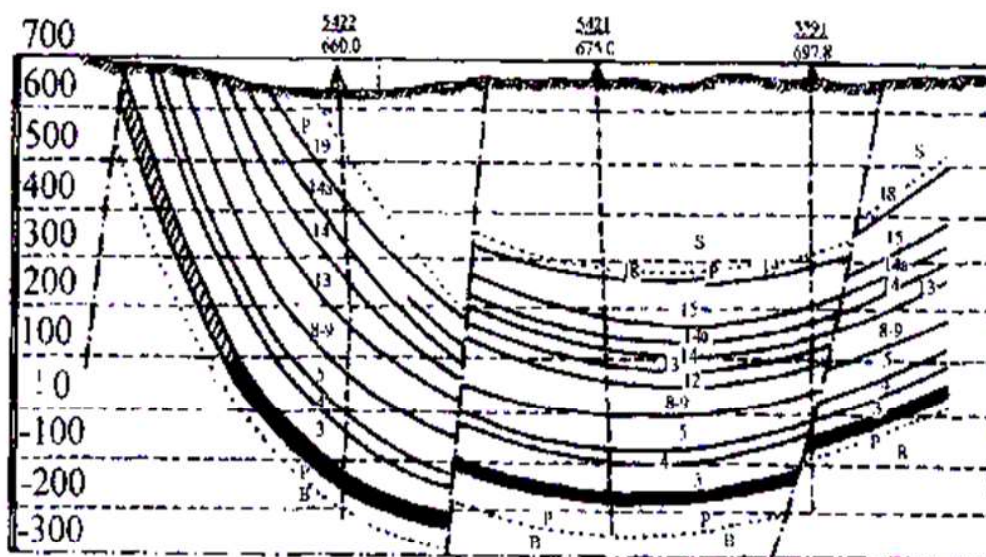

Figure 5. Structure of coal seams in the Jiu Valley mining basin

### 3.2. Subsidence phenomena in Lonea mine

The Lonea mining perimeter is located in the northeastern extremity of the basin, east of the Jieț brook, which separates it from the Petrila and Livezeni perimeters.

The deposit is compartmentalized in blocks of predominantly transversal faults, the directional ones being proved by the research works in the northern area / 9 /.

The seams of economic importance, which are the object of working are 3 and 5. For the working of seam 3, over time, the following methods have been applied:

- mining method with short front in horizontal slices;
- mining method with longwall in horizontal slices;
- mining method with undermined coal bank.

The tracking station located in the Lonea mining field (fig.6) had as objectives the establishment of the parameters of displacement and deformation of the surface from the roof seam 3, block VI and of the diving limit angle [14]. The station was composed of a diagonal alignment materialized and followed by ICPMC since 1979, and in 1985 was materialized, by the Department of Mining Topography of the Institute of Mines (today the University) of Petroșani, a station for monitoring the phenomenon of sinking at the Lonea mine in the case of seams 3 and 5, block VI [10] consisting of two alignments: one directional, with a single stable end consisting of 14 tracking marks (with a total length of 380m) and a transverse one, with a single stable end consisting of 35 landmarks (with a total length of 558m).

The directional alignment was followed until 1987, when the stable landmark of the alignment disappeared, and observations were made on the transverse alignment until 1996.

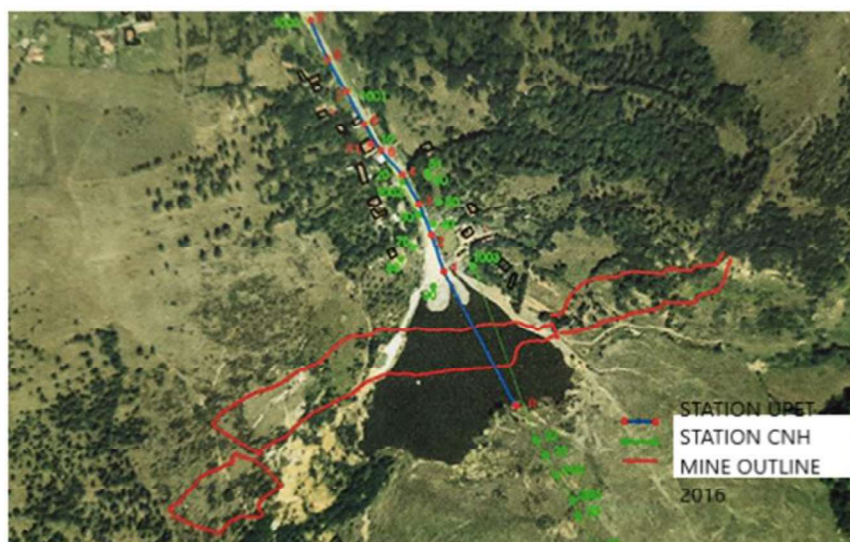

**Figure 6.** Tracking station at the Lonea mine [10]

This monitoring station provided data on the displacement and deformation of the land surface following the exploitation of seams 3 and 5 of block VI. The inclination

of the layers is approx. 300, and the thickness of seam 3 of approx. 28-42m, and of seam 5 of approx. 4-5m. (fig.7).

The mining method applied at that time was in descending horizontal slices, with pressure control by total collapse of the surrounding rocks.

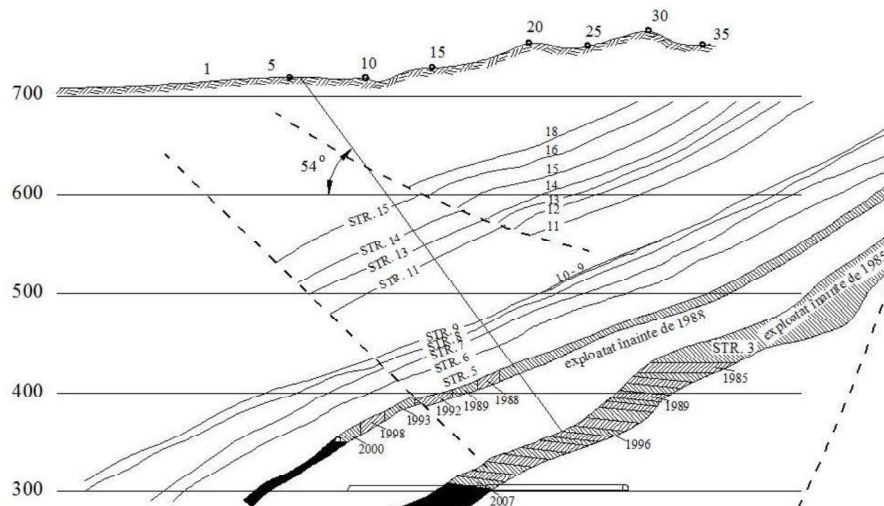

Figure 7. Cross section at the Lonea mine [9]

The diving curves measured in time and their statistical approximation with the help of the general profile function (established by the authors of the paper /10/) are represented in fig.8.

It is observed that due to the deep advancement of the exploitation of the deposit, the position of the point that reaches the maximum submersion, for each intermediate submersion, changes, and the submersion develops asymmetrically and far to the side.

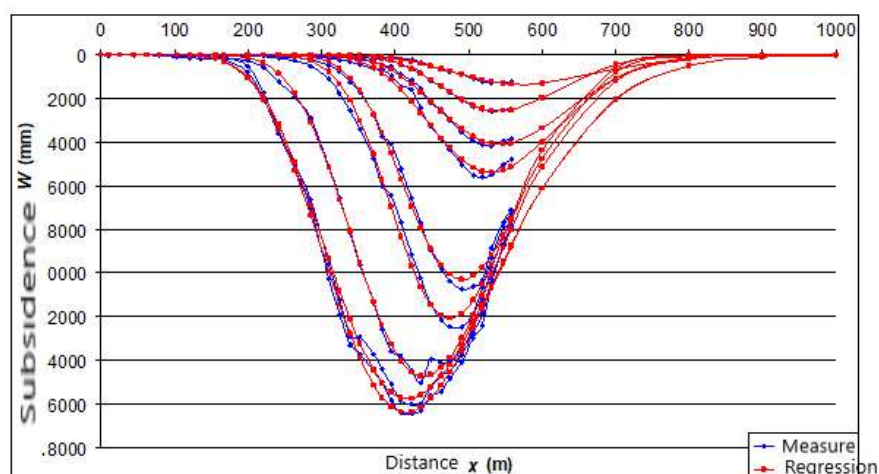

Figure 8. Measured and approximated diving curves, as a function of time, in the case of seams 3 and 5, block VI, from Lonea mine [9]

The displacements and deformations of the land as a result of the exploitation of seams 3 and 5 produced cracks, fissures and even collapses on the surface of the land, and cracks and fissures in buildings (fig.9)



**Figure 9.** Subsidence phenomena in Lonea mine

### ***3.3. Subsidence phenomena in Petrila mine***

The Petrila mining perimeter is located on the northeastern frame of the basin and is bounded on the north by the East Jiul, on the south by the Maleia brook, which separates it from the Livezeni perimeter, on the east by the Jieț brook and a conventional boundary, which separates it from the perimeter. Lonea mining, and to the west the Jiul de Est river, which separates it from the Dâlja mining perimeter [10].

It is divided into blocks by a fault system, mostly transverse to the deposit.

The main seams that are exploited are 3 and 5 and with a lower weight 4, 7, 8/9, 12 and 13.

Since 1978, the exploitation of seam 3, below the horizon. + 300m, was made by the method of exploitation in horizontal slices with the direction of the pressure by hydraulic backfilling, up to the elevation of + 250m. Since 1989, the exploitation of seam 3, at the level of the 138 and 139 abatements was carried out by the method of exploitation with frontal abatements, with the direction of the pressure by total collapse of the rocks.

The method of exploitation of seam 3 with high inclination is with undermined coal bank.

In 1981, a diving tracking station was built at the Petrița mine, consisting of a single alignment with 16 tracking landmarks arranged at a distance of 250m to observe the subsidence phenomena caused by the exploitation of seam 3, below the horizon 300, by the method of operation in horizontal slices at the level of the abatements 138 and 139 with the control of the pressure by total collapse. During 1991, in the 139 slaughterhouse, the total backfilling was performed at the level of the horizon 200 /10/ (fig.10).



**Figure 10.** Tracking station at the Petrița mine [10]

Since 2011, the subsidence phenomenon at the Petrița mine has been monitored through a tracking station consisting of three alignments: one transverse with 12 landmarks and two longitudinal with 17 landmarks (east) and 11 landmarks (west), respectively.

The curves of the dives and those resulting from the time-dependent profile function are represented in fig.11.

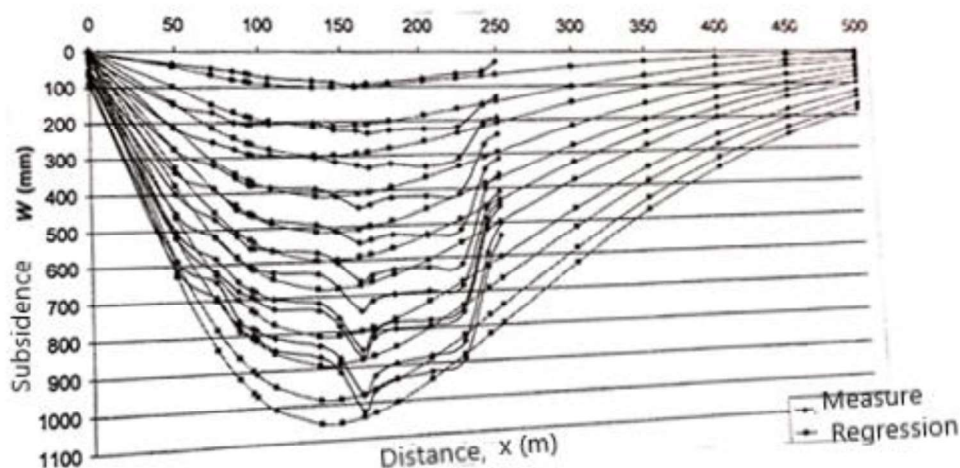

**Figure 11.** Diving curves and approximate needles using the profile function for the case of seam 3, front faces 138 and 139, from the Petrila mine [10]

Although seam 3, mined at the Petrila mine, has a thickness of 35m and a large inclination, the submergence at the surface is somewhat reduced, being 1032mm. This is due to the fact that, for the most part, the exploited space has been completely backfilled.

### 3.4. Subsidence phenomena in Dâlja mine

The phenomenon of displacement of the land surface, as a result of the underground exploitation, at the Dâlja mine, is not followed at present because the activity at this mine has been stopped since 1999, entering the closure program in 2004.

The measurements performed on a tracking station that was materialized in 1975, consisting of a transverse profile with two stable ends, comprising a number of 33 landmarks, arranged over a distance of 841.8 m [10].

The observations on this tracking station were made biannually, until 1981. This station had the role of tracking the displacements and deformations of the land surface caused by the exploitation of seam 3, block III, exploited in horizontal slices with total collapse of the surrounding rocks. In this block seam 3 had a thickness between 2m and 11m and a large slope of approx. 600-680 /10/.

The measured and statistically approximated diving curves, developed over time, are represented in fig.12.

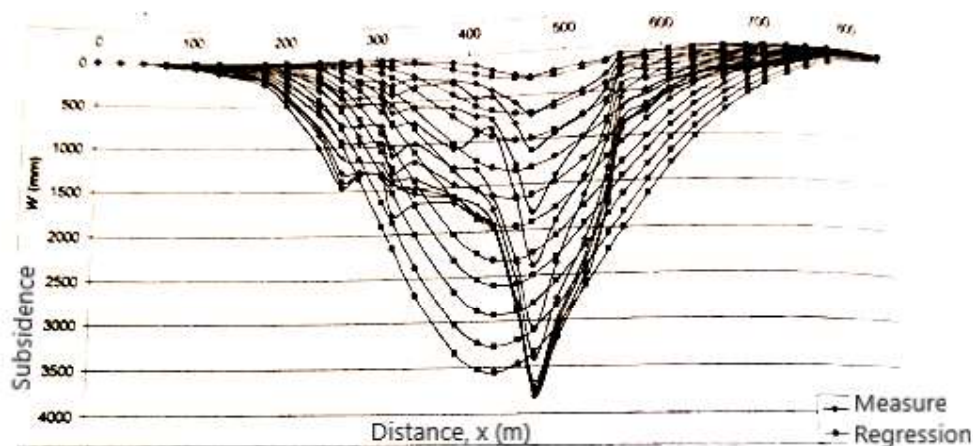

**Figure 12.** Diving curves, developed over time, in the case of seam 3, block III, from the Dâlja mine

As can be seen from fig.12 the diving curves at the Dâlja mine have a slightly irregular shape due to the complex diving phenomenon generated by the exploitation, over time, of several successive slices and several abatements. Also, the high inclination of almost 70° can be another factor that explains the contribution of some secondary phenomena to the development of complicated subsidence phenomena, such as the slipping of rocks, both from the roof and from the bed of seam 3.

The maximum immersion measured in this tracking station is 3814mm.

### 3.5. Subsidence phenomena in Livezeni mine

The Livezeni mining perimeter is between the Petrila and Lonea mining perimeters to the north and northeast and Sălătruc to the south, Dâlja and Iscroni to the west (closed mining perimeters).

The deposit is fragmented into blocks.

The most economically important coal seams are 3 and 5.

At the Livezeni mine for the exploitation of 3rd street, the method of exploitation in slice on inclination was applied with the total collapse of the rocks from the roof, at great thicknesses of the layer and the method of exploitation with undermined coal bank, at inclinations up to 22° of the layer.

The tracking of the displacement and deformation of the land from the surface under the influence of the underground exploitation at Livezeni mine is carried out by means of a tracking station consisting of 50 landmarks with a total length of 1485.9 m (fig.13). Their arrangement was made along the road that makes access to the tourist areas of the Parâng Mountains [11].



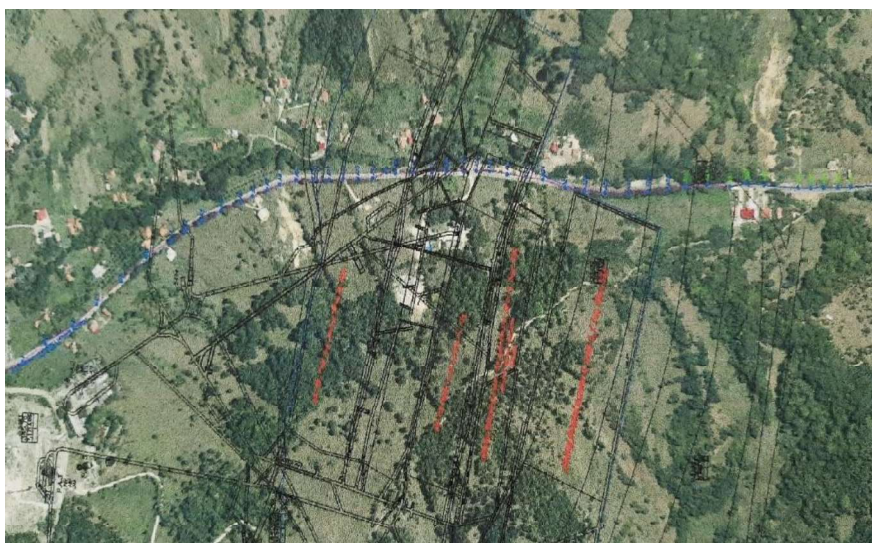

**Figure 13.** Tracking station at the Livezeni mine [11]

This tracking station provides data on the displacement and deformation of the land surface following the exploitation of seam 3, block VI A, panels 3-4, 5, and 6 (fig.14).

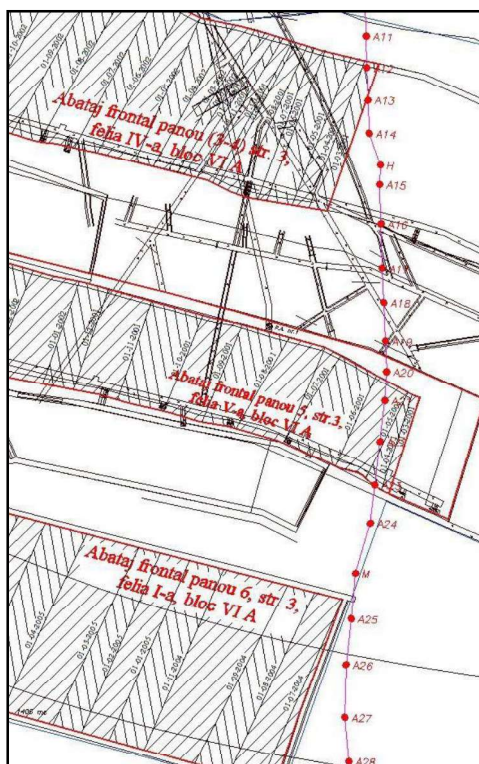
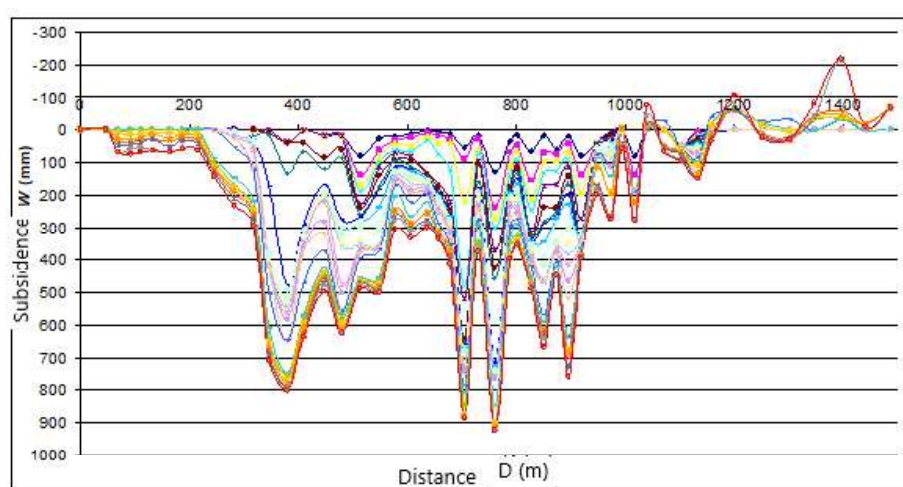

**Figure 14.** Situation plan for the exploitation of seam 3, block VI A, panels 3-4, 5, and 6 at the Livezeni mine

The topographic observations were made every 3 months, starting with 2001. Over time, most of the initial landmarks that formed this tracking station disappeared and were replaced with new ones. For this reason, the interpretation of the measurements made on this tracking station was cumbersome and did not provide satisfactory results in terms of the extent of surface degradation in this area.

The measured diving bed is a composite bed (fig.15), resulting from the exploitation of the three abatements. This dive bed has an irregular (somewhat sinusoidal) shape because the four individual dive beds (of each exploited space) intersect, but also because the tracking station was located at the edge of the exploited spaces, area where the transverse deviations are maximum.

The maximum immersion measured in this tracking station is 924mm.



**Figure 15.** The diving curves followed in time at Livezeni mine [9]

### **3.6. Subsidence phenomena in Paroşeni mine**

The Paroşeni mining perimeter is comprised between the perimeters: Lupeni in the west and Vulcan in the east, in an area where the deposits of Horizon III are eroded, and on some surfaces even a part of horizon II up to the level of seam 15.

The deposit in this area is strongly tectonized, an important transversal fault, located on Valea Lupului, separating the western part of the basin from the eastern one.

The seams with economic importance are: 3, 5, 8/9, 13, 14, 15 and 18, and the object of exploitation in the Paroşeni mining perimeter was formed by seams 18, 15, 13 and more recently seams 5 and 3.

The mining method applied for thick layers is in long-sloping slices.

The monitoring of the land deformation phenomenon, as a result of the underground exploitation at the Paroşeni mine, was carried out through an alignment with a total length of 1600m composed of a number of 63 landmarks, with the aim of monitoring the access road to the return station. of the tailings funicular /5/.

In that area were exploited seam 3, in panels 1, 2, 3 of block VI and seam 5 in panel 6, block III and panels 6 and 7, block V (fig.16).

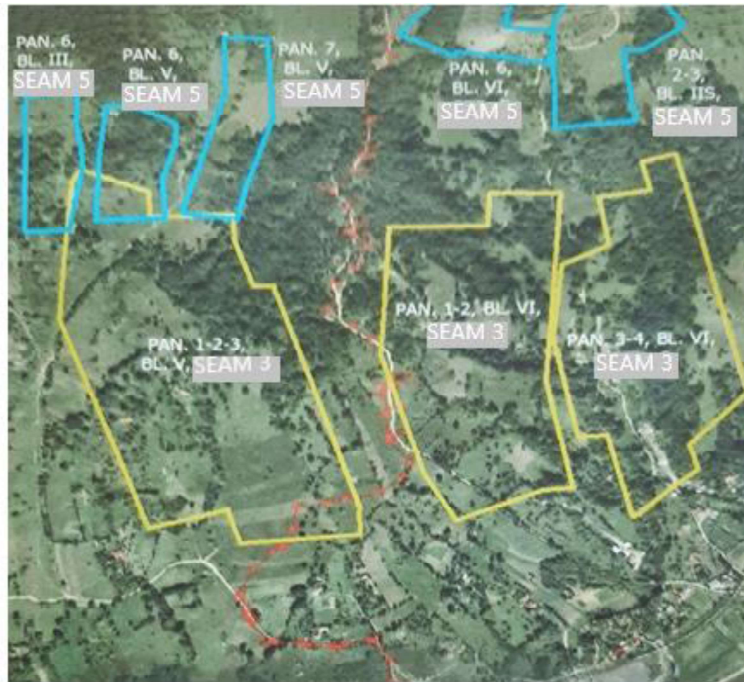
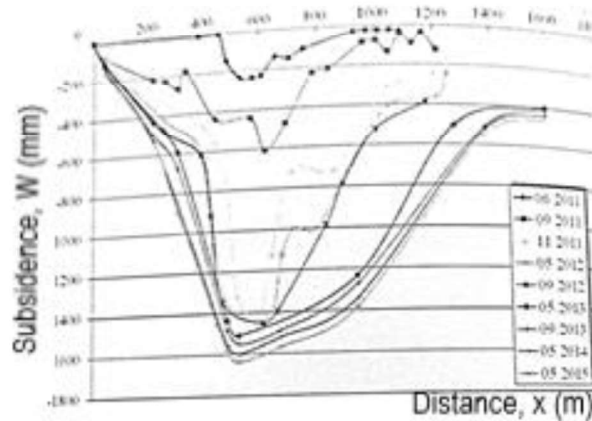

**Figure 16.** Monitoring area at the Paroşeni mine [6]

The monitoring period was between June 2011 and May 2015, and because during this period some of the initial landmarks disappeared, only the remaining points during the monitoring of the phenomenon of monitoring were taken into account in the graphical representation of the sinkhole. subsidence.

From the processing of data obtained from field measurements, the maximum immersion of the surface was 1638mm (in May 2015).

Fig. 17 shows the development over time of the diving bed obtained from field measurements [5].



**Figure 17.** Graph of the subsidence bed resulting from measurements at the Paroşeni mine [5].

### 3.7. Subsidence phenomena in Vulcan mine

The Vulcan mining perimeter is framed between the Lupeni and Paroşeni mining perimeters to the west and Aninoasa to the east.

The deposit is tectonized, the system of transverse and directional fractures divided it into 10 tectonic blocks, which tend to descend to the east.

Seams of economic importance are 3, 5, 7, 8/9, 13, 15 and 18. Seams 18, 15 and 13 have been exploited between horizons 480-320m over large areas, and seams 8/9, 7, 5 and 3 they were exploited only at the upper horizons (fig.18).

The most frequently applied mining method is the one with coal bank undermined especially at medium inclinations of the seams [9].

The tracking of the land surface movement under the influence of underground mining at the Vulcan mine was performed through a tracking station consisting of 16 landmarks located on an alignment with a total length of 620.8 m [10].

The topographic observations were performed every 3 months, starting with June 2008. This tracking station provided data on the displacement and deformation of the land surface following the exploitation of seam 3, block VII-VIII, coal face 366 and 376 (fig.19).

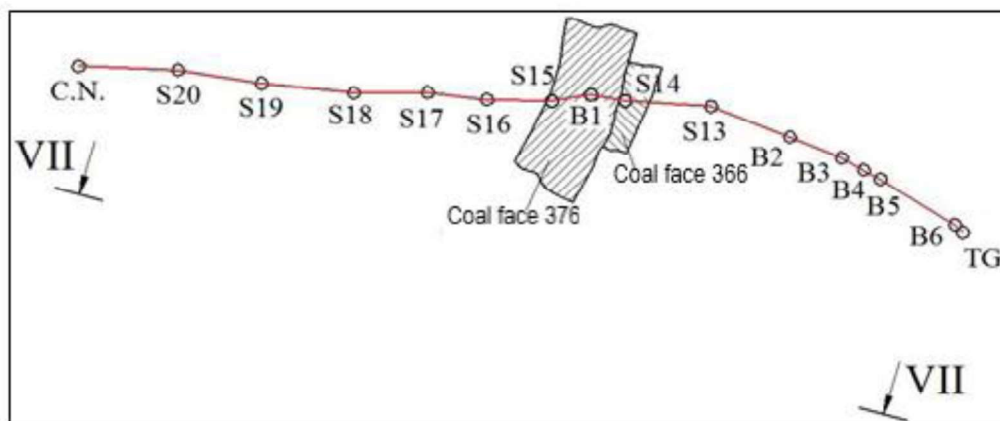

Figure 18. Surface displacement tracking station at Vulcan mine [9]

The exploitation of seam 3 at the Vulcan mine, with an average horizontal thickness of 50m, started in 1964 applying the method of exploitation in descending horizontal slices with the collapse of the surrounding rocks.

Seam 3, corresponding to the two abatements (366 and 376), was exploited in horizontal slices, with undermined coal bank.

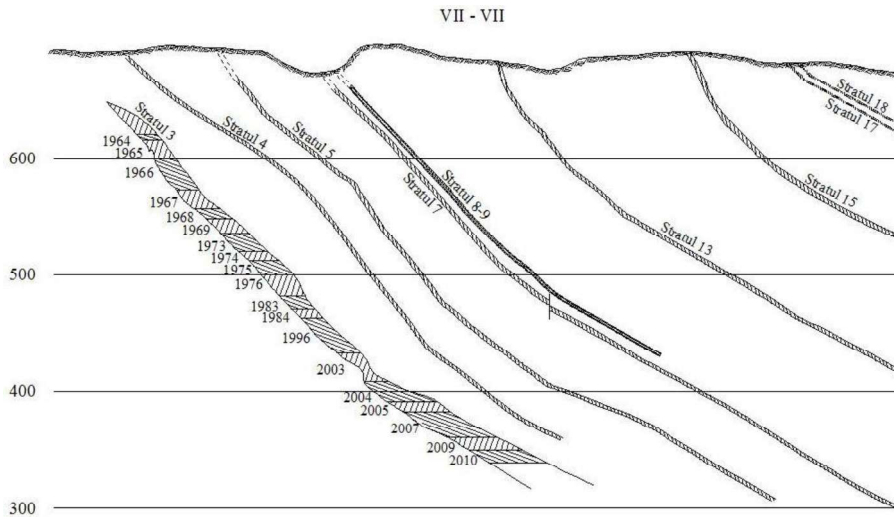

Figure 19. Vertical cross section, Vulcan mine [9]

The diving curves, measured in time, as well as the approximation curves of the time-dependent profile function are presented graphically in fig.20.

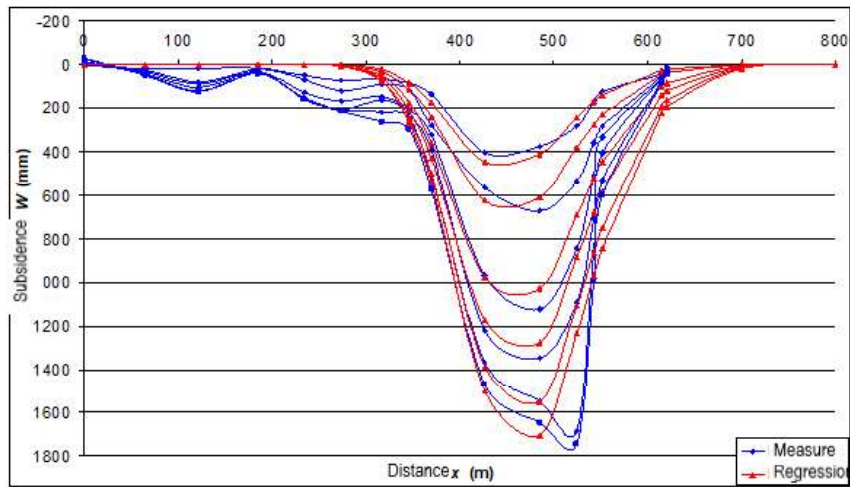

Figure 20. Real-time diving curves and time-dependent profile function for street 3, block VII-VIII, abatements 366 and 376 at the Vulcan mine [9].

As can be seen from fig.20, as the cutting edge advances, the position of the point that reaches the maximum submersion, for each intermediate submersion, changes. The maximum immersion is 1782.9mm.

The phenomenon of displacement of the land surface in the case of the Vulcan mine is in the active phase, the exploitation being completed. According to the research results recorded in the paper [9] the average immersion speed determined is 102.4 mm/month.

### 3.8. Subsidence phenomena in Vulcan mine

#### 3.8.1. Phenomena of continuous subsidence

The Lupeni mining perimeter is delimited by the Vulcan and Paroşeni mining perimeters to the east, and to the west by the Bărbăteni perimeter (closed).

The coal layers that are of economic importance are the seams: 3, 4, 5, 8/9, 13, 14 and 15, which are currently exploited between the horizons 800 ÷ 300m.

The underground exploitation of the coal layers from the Lupeni mining field has major implications in terms of the stability of the land, but also of the surface constructions.

Seam3, block IV was exploited by collapsing the roof rocks, using mechanized complexes (Panel 1C) and undermined coal bank (Panel 3, Panel 3E, Panel 4E, Panel 8A, Panel 8B and Panel 8C), total height of the resulting exploited space being between 25m and 30m.

In order to monitor the phenomenon of land deformation, as a result of the underground exploitation of seam 3, a route was made composed of a total number of 14 points, arranged on a total length of 665m (fig.21). Measurements performed on the alignment points were performed at irregular intervals (6 months, 3 months and 5 months) /3/.

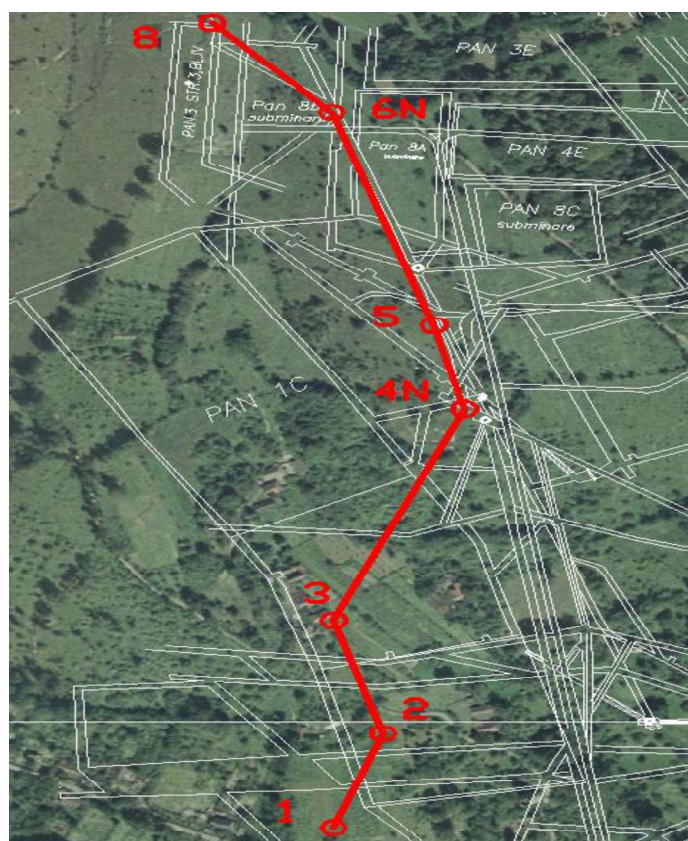
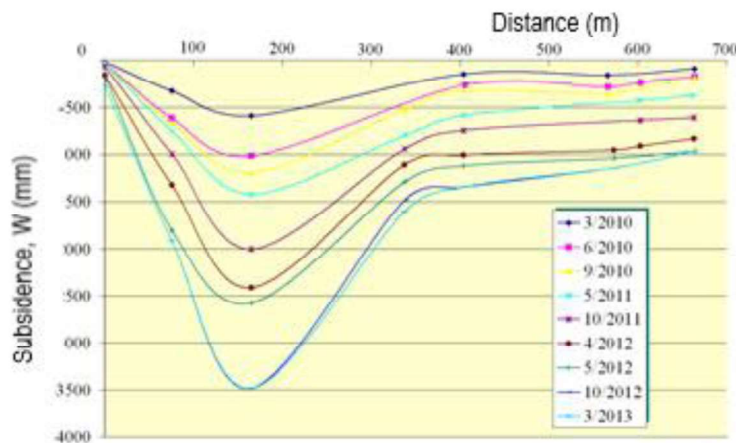

Figure 21. Diving follow-up alignment at Lupeni mine [3]

It should be mentioned that this monitoring route is the only one on which systematic topographic measurements were carried out, in the perimeter of the Lupeni mine and which offers indications on the intensity of the subsidence phenomenon in the area of influence of the frontal mines with undermined coal bank, from this mine [12].

After processing the data obtained from the measurements performed in the field, it resulted that the maximum immersion of the field is 3 483 mm (in March 2013) [3].

The development in time of the diving bed, based on the measurements performed, is presented in fig.22 [3].



**Figure 22.** Graph of the diving bed resulting from measurements at the Lupeni Mine [3]

From the graphical representation of the evolution in time of the maximum diving (fig.22) it can be seen that this tracking station was made when the phenomenon of land diving had already begun to manifest itself, it being in the second stage namely the main stage (development) of the phenomenon. During this period, the ground diving rate calculated as the ratio between the diving of the landmark and the time period between two measurements is between 142mm/month, in the first period of tracking the phenomenon and 181mm/month, in the last period.

It can also be seen that between September 2010 - May 2011 (the period between 12 and 20 months of monitoring), October 2012 - March 2013 (the period between 40 and 45 months of monitoring), the rate of decrease is significant. reduced from 142mm/month, in the first monitoring period, to 27mm/month, which may lead to the erroneous conclusion that the phenomenon has entered the final phase (extinguishing phase) [3].

In order to ensure that the underground operation does not affect the surface objectives, a series of safety pillars have been delimited, so that, in terms of major industrial and civil objectives (hospitals, schools, compressor station, degassing station etc.), they should not be affected by underground mining. As for the individual civil constructions, they were affected by the underground exploitation, but they were not carefully monitored by the Lupeni mine, after 1989, it being satisfied only to compensate the people who suffered damages due to the underground exploitation.

Some of the effects of the land subsidence phenomenon on the constructions located in the area of influence of the underground exploitation of the coal layers located in the perimeter of the Lupeni mine, are presented in fig.23.

As can be seen in the images in fig.23, most of the affected buildings (residential houses) are with a single level, made of brick walls, on monolithic concrete or river stone foundations and are over 50 years old.

Due to the differentiated displacements of the surface, generated by the underground exploitation, the movement propagated through the foundation of the buildings, to their superstructure, initially causing traction and shear cracks, which progressed gradually over time until the structural elements are completely decomposed.

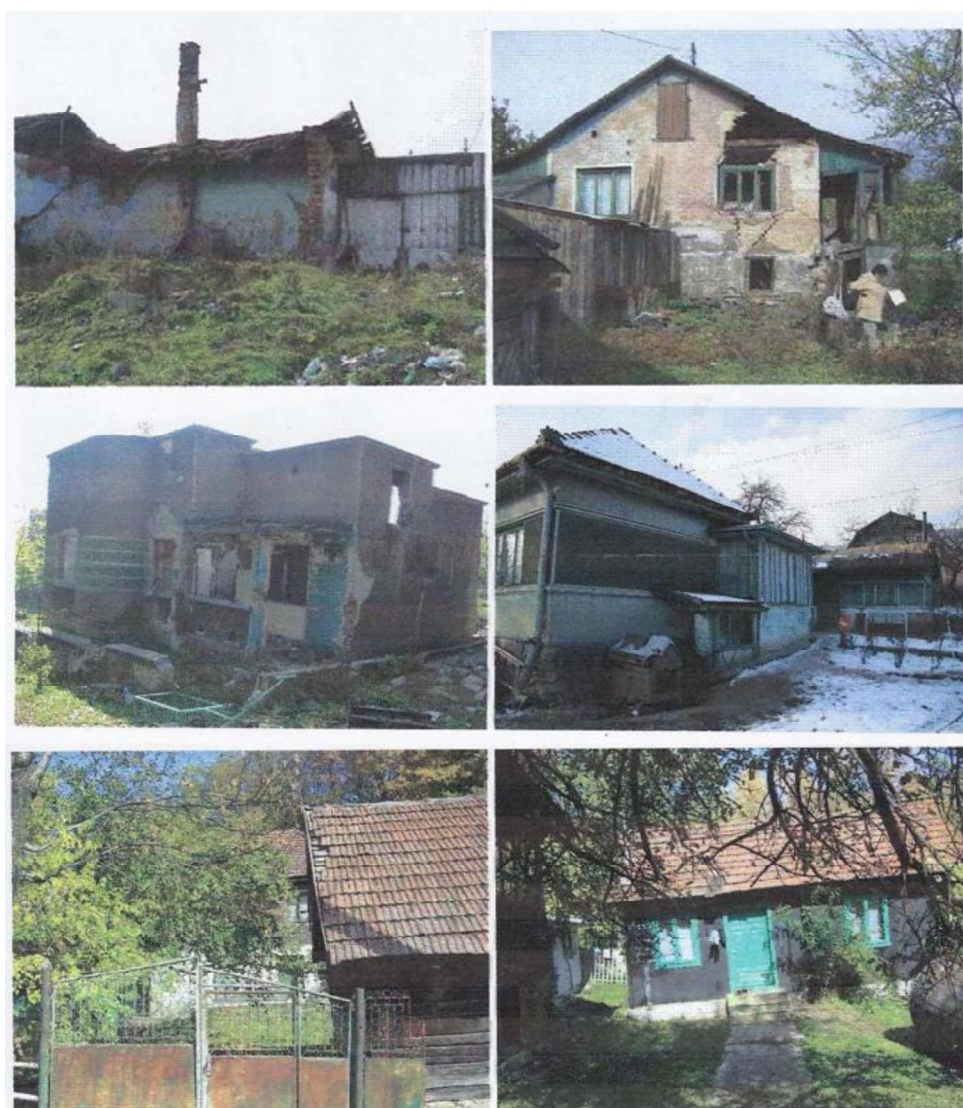

**Figure 23.** The influence of underground mining on some constructions, in the case of Lupeni mine [6]



3.8.2. The phenomenon of discontinuous subsidence

Starting with 2008, in the perimeter of block V, from EM Lupeni, three pits appeared successively on the surface of the current land, in the areas of influence of panels P6 / I, P9, P7 and P10, atypical for the geo-mining conditions in Jiu Valley (see fig.24):

- in 2008: Pit 1 of Panel 6/I;
- in 2014: Pit 2 in Panel 10;
- in 2018: Pit 3 between Panel 9 and Panel 6/I.

Block V is located in the eastern extremity of the perimeter, being delimited to the west, by a fault, by block IV, and to the east, by a conventional limit, by the development-exploitation perimeter Paroşeni. Characteristic of the V block is the accentuated microtectonics. In all the panels in operation, many faults were highlighted, whose amplitude varies between 0.5 and 7.0m. The inclination within the block is  $8^{\circ} \div 10^{\circ}$ . (fig.25).

The phenomenon of chimneys/potholes at Lupeni Mine is unique in the Valea Jiului coal basin, since the beginning of mining in the Jiu Valley. Therefore, no research work has been undertaken so far, having as subject this type of discontinuous subsidence phenomena.

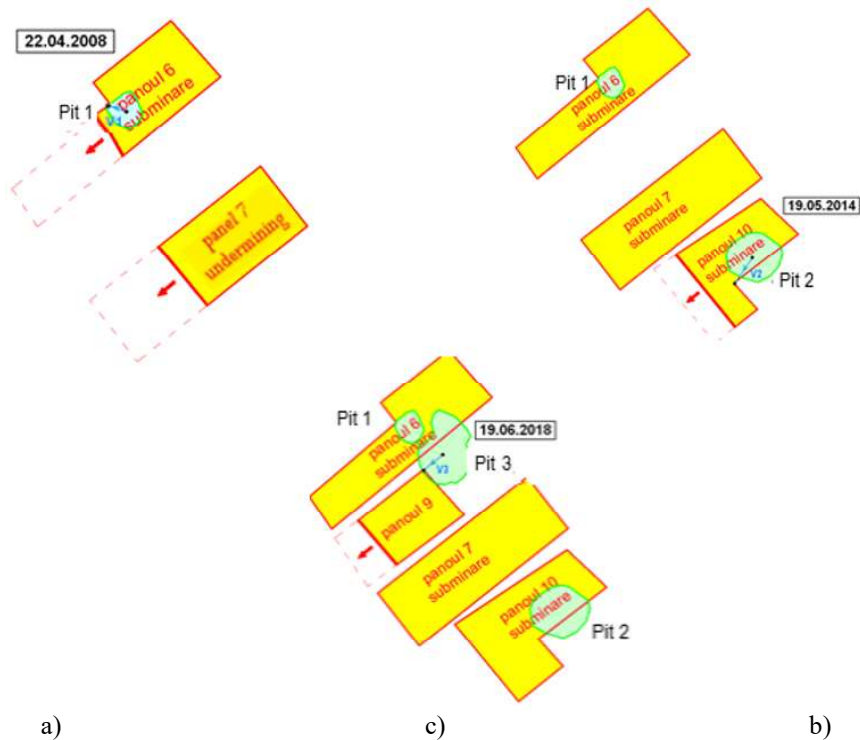

**Figure 24.** Situation plan for the operation of the panels at the date of the appearance of the landslides [12]

a. Pit 1: 2008; b. Pit 2: 2014; c. Pit 3: 2018

V1, V2 and V3 - gravitational displacement of rocks on landslides

The appearance of the three chimneys/potholes in the perimeter of the Lupeni mine was determined by the overlap of three causes: an average depth of location of the level of exploitation of approx. 242 - 275m; mining in sloping slices, with a high height undermined coal bank, 15-35m; the presence of normal faults near the exploited panels; concentration of stresses on the corners of the pillars between the panels.

The decipherment of the geomechanical phenomenon and the causes that led to the appearance of these collapses / potholes and to the evaluation of the risk of similar phenomena, at least in the analyzed area of block V, from the Lupeni mine was performed by specialists from the University from Petroșani [12].

The authors of this study [12] claim that all the mentioned causes (none of them being excluded) contributed cumulatively to the appearance of the geo-mechanical phenomenon of the chimneys/potholes from the Lupeni mine.

All three collapsing pits appeared during the exploitation process with front deflections and undermined coal bank of the panels: Pit 1 - panel P6 / I; Pit 2- panel P10; Pit 3 - panel P9. Therefore, it can be noticed that the phenomenon of the appearance of collapsing pits was triggered in the exploited spaces where the movement of the rocks was not completely stabilized.

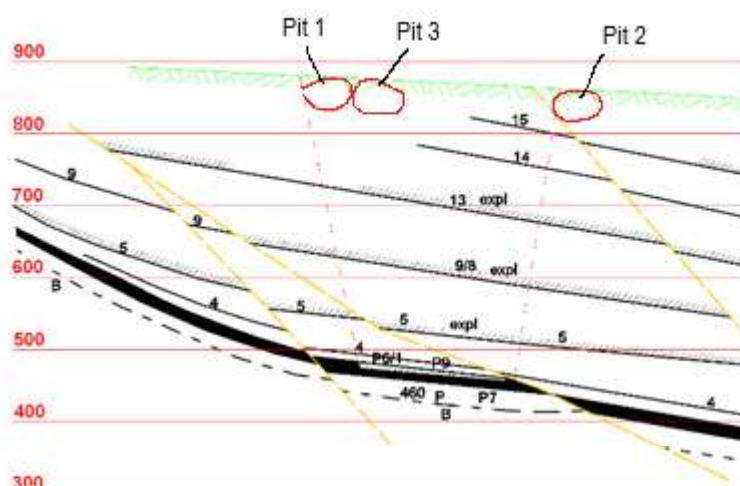
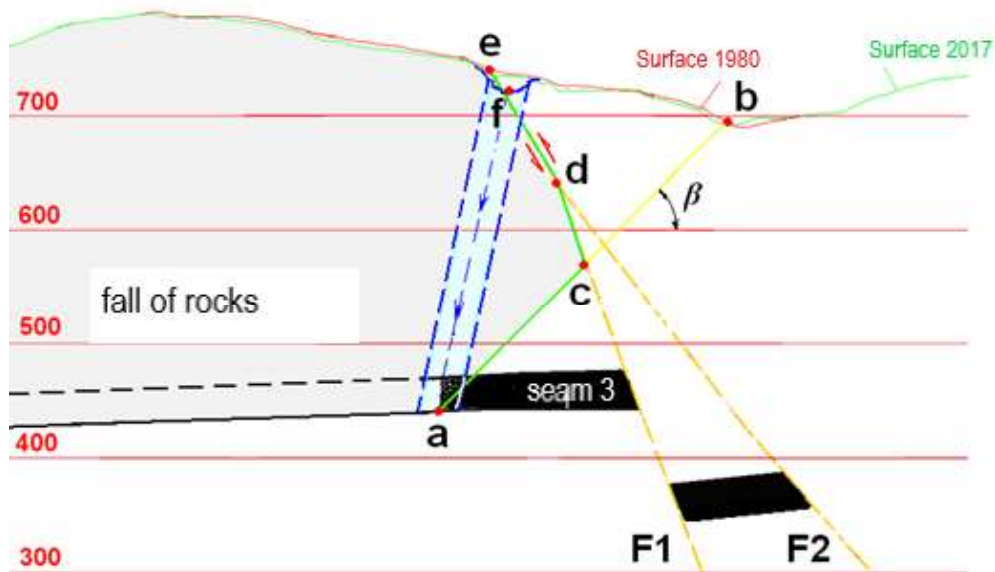

**Figure 25.** Representative section through deposit with the main tectonic accidents [12]

Figure 26 summarizes the appearance of the three landslides in the perimeter of the Lupeni mine.

During the exploitation with undermined coal bank of layer 3, respectively successively in panels P6, P10 and P9, after a certain distance from the starting line of the abatement the rocks from the roof of seam 3, set in motion by some ellipsoids, at each 1.25m advance step, they continued their tendency to move after an „ab” diving plane, inclined at an angle  $\beta$  to the horizontal. However, reaching the plane of the F1 fault, in point „c”, they determined the detachment of the rocks on the fault plane, then they continued their movement until point „d”, where the moving rocks met the plane of

the F2 fault, thus deviating the displacement after the inclination. to this fault, up to the surface, at the „e” point of outcrop of the F2 fault. Thus, due to the shearing and detachment of the rocks according to the fault planes, the breaking surface marked by the „acde” points delimited a partition wall between the moving rocks (vertical and horizontal displacement), located above the operating panel, and the massif of intact rocks [12].



**Figure 26.** Mechanism of formation of collapse chimneys following the exploitation of seam 3, block V

F1, F2 - major faults; a, b - the diving plane inclined at an angle; a, f - the axis of the collapse basket; a, c, d, e - the area delimiting the area of rock movement from the area of the rock massif [12]

If there had been no faults at the boundary with the exploited panels, then the rocks in the direct and main roof would have moved according to the "ab" sinking plan, would have loosened progressively, and would have led to the total movement of the rocks and implicitly to the deformation of the land from the surface, where some continuous sinkholes would have formed. The presence of faults determined the change of the behavior of the rocks in the roof, generating the appearance of discontinuous deformations at the surface of the land from the day.

At the end of the study [12] the authors found that there are almost all the conditions for a new sink / pit to appear between panel P9 and panel P7, during the extraction of coal from panel P9. If so, then the latter would join pit no. 3, producing a huge pit, with an elliptical profile, oriented in the direction of the major faults in block V. However, this phenomenon may not occur, due to the de-stressing of the rocks following the collapses that caused pit no. 3, which exceeded the plan of the faults, thus bringing an additional contribution of loose rocks from the bank of rocks located above the fault, so that the outcrop of the fault.

Fig.27 shows the three pits at different stages of their formation.

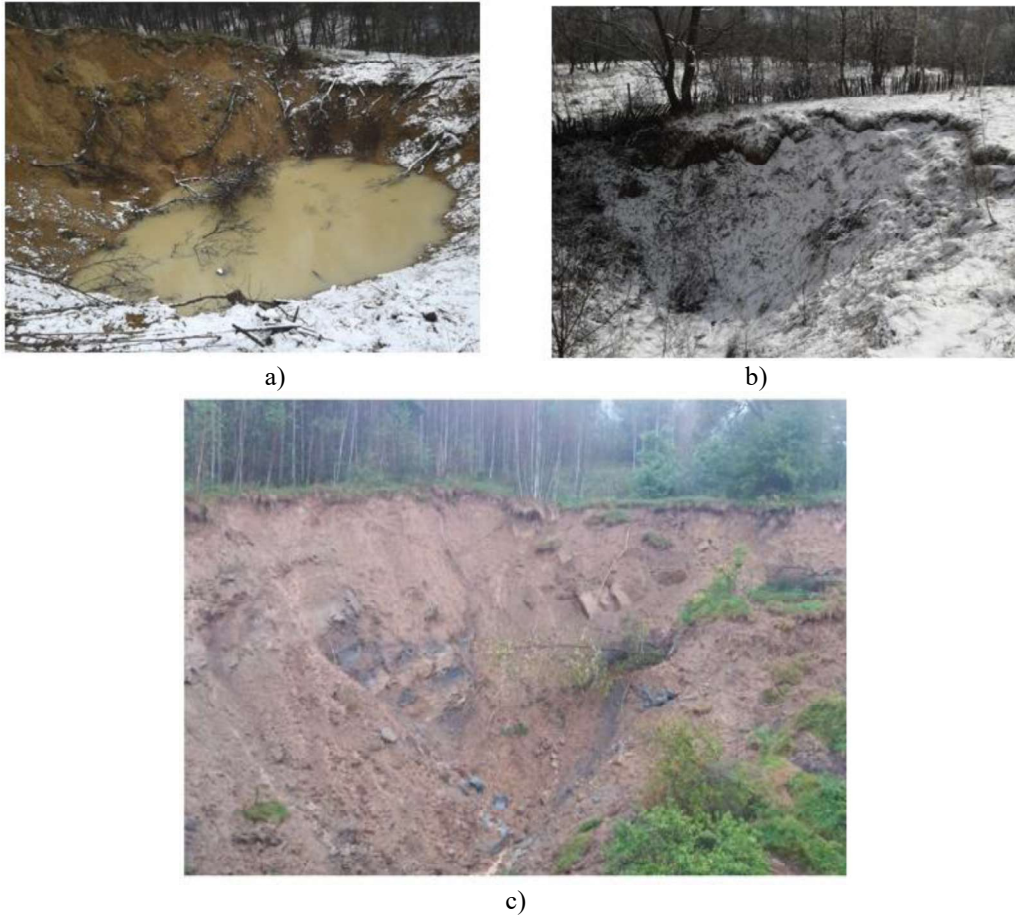

**Figure 27.** Collapsing pits [12]  
a.- Pit 1 (22.04.2008); b.- Pit 2 (19.05.2014); c.- Pit 3 (19.06.2018)

### **3.9. Subsidence phenomena in Uricani mine**

The Uricani mining perimeter is located between the Valea de Brazi mining perimeters to the west and Bărbăteni to the east (closed perimeters).

From a tectonic point of view, the transverse faults compartmentalize the deposit into blocks.

The object of exploitation in this perimeter was formed by seams 3, 5, 8/9, 13, 14 and 18.

The following methods of operation were applied: with a mined coal bank for layers with an inclination up to  $22^{\circ}$ , with a long direction on the direction and with inclined columns for thin and medium-thick seams.

The tracking of the displacement and deformation of the land surface under the influence of the underground exploitation at the Uricani mine was carried out by means

of a tracking station with a total length of 563.6m consisting of 10 landmarks (fig.28) [10].

The topographic observations were made every 3 months, starting with October 2007. This tracking station provided data on the displacement and deformation of the land surface following the exploitation of seam 3, block V, panel 1 (fig.29).



**Figure 28.** Tracking station at the Uricani mine [6]

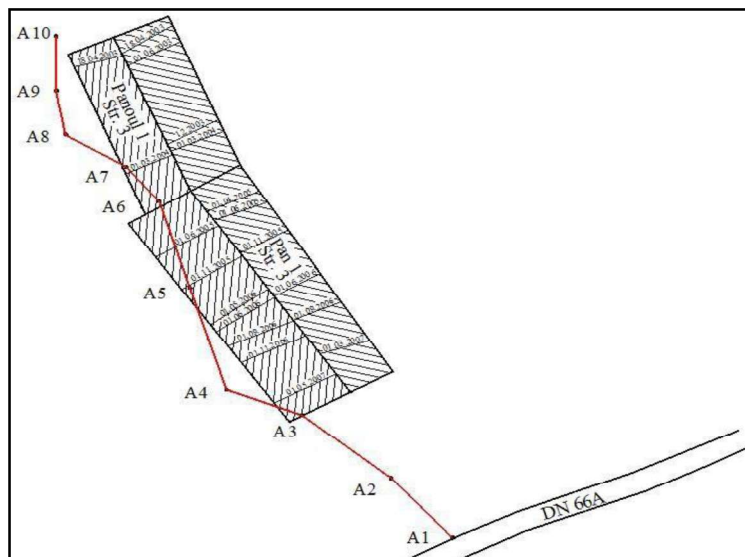
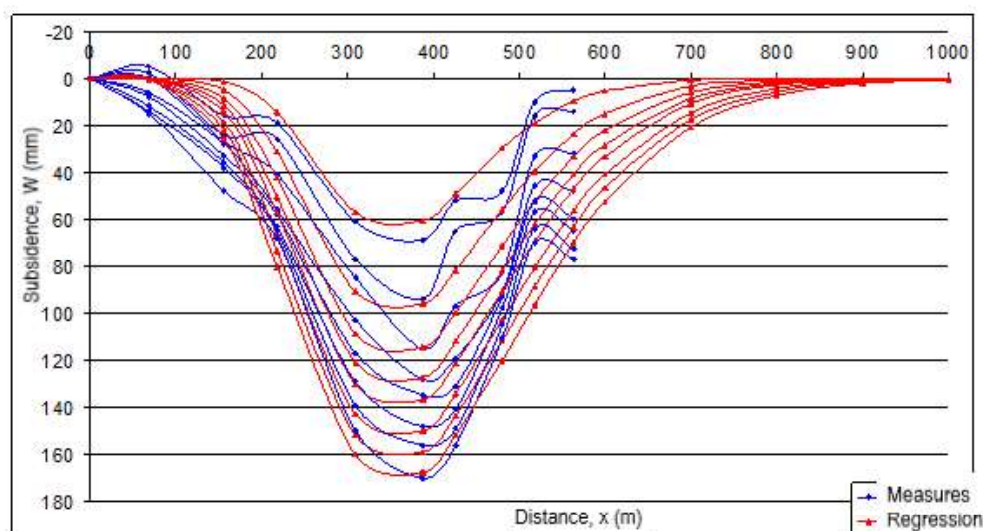

**Figure 29.** Tracking the displacement and deformation of the land surface following the exploitation of seam 3, block V, panel 1, at the Uricani mine [9]

The exploitation of seam 3 with an inclination below 100 was made with a mined coal bank, on all its thickness (10m), with a long felling front, with an average length of 90m and the extension of the panel of 354m. Operation of this panel began in 2003 and ended at the end of 2007.

The diving curves measured in time as well as their statistical approximation with the help of the generalized, time-dependent profile function are represented in fig.30.

The maximum immersion measured in this station is 170mm.



**Figure 30.** Tracking the displacement and deformation of the land surface following the exploitation of seam 3, block V, panel 1, at the Uricani mine [9]

#### 4. CONCLUSIONS

Currently, Jiu Valley mining basin remains the only national mining basin capable of producing coal, with geological reserves in concession areas of about 300 million tons, of which exploitable (for which there is a license) 50 million tons.

With the reconsideration of coal mining in Jiu Valley due to the closure of several mines and the revaluation of surface land and the assessment of the stability of some constructions appeared the need to analyze the state of surface land affected by the influence of underground mining.

Depending on the geological and mining conditions, the coal mining operations in the Jiu Valley led to the submergence of the surface land (vertical displacements) at levels ranging from 1 meter (in the case of coal layers with reduced thickness and inclination) and dozens of meters (in the case of thick and very sloping coal seams) as is the case from Lonea mine and Lupeni mine [2].

As a result of these situations, it was necessary to immediately evaluate the measurements performed over time, in different mining perimeters of Jiu Valley and to analyze the databases accumulated at the level of the entire mining basin.

The analysis of the data proved, however, very difficult because the tracking of the surface deformation, over time, was done after a series of alignments that were not always scientifically relevant, because the purpose of these monitoring was, almost exclusively, of pursuing the stability of roads, constructions, land areas and other objectives of immediate interest.

In the case of mines in Jiu Valley, the monitoring of the surface subsidence phenomenon as a result of underground exploitation was done by classical topographic methods, the determination of the height of the points forming the monitoring station is done by topographic methods, namely middle geometric leveling and/or trigonometric leveling.

The problem of surface deformation as a result of underground mining has occupied and still occupies an important place in the field of mining scientific research. Solving it makes it possible to predict the effects of underground mining on the land surface and offers the possibility to take appropriate measures to protect the objectives on it.

Researchers have recently sought to address these shortcomings in topographic measurements by currently using methods for predicting sinking phenomena, such as mathematical-analytical methods (empirical or model-based).

This paper presented a theoretical part, known and accepted in the literature, on the study of subsidence phenomena that may occur from the underground exploitation of a deposit and a part of analysis of these phenomena that occurred in the closed mining perimeters of Jiu Valley focusing on the effects of underground mining on land and buildings on the surface of these mines.

## 5. REFERENCES

- [1]. Fissgus, K.- Researches regarding the forecast of the phenomenon of land surface displacement in the Jiu Valley mining basin, Doctoral thesis (in Romanian), University of Petroșani, 2002
- [2]. Floarea D., Onica I., Cozma E., Marian D.P.- Necessity of Subsidence Phenomenon Monitoring in the case of Sustainable Development of Jiu Valley Coal Basin Conditions, Annals of the University of Petroșani-Mining Engineering, Vol. 15/2014
- [3]. Floarea, D.A., Onica, I., Marian, D.P.- Monitoring Surface Land Deformation and Analysis of Data for Lupeni Mine, Annals of the University of Petroșani Mining Engineering, No.18 / 2017
- [4]. Floarea, DA, Onica, I., Marian, DP- 3D Finite Element Modeling of the Land Stability Affected by the Underground Mining of the Coal Seams from the Jiu Valley, Annals of the University of Petroșani Mining Engineering, No.18 / 2017
- [5]. Floarea, D.A., Onica, I., Marian, R.R.- Surface deformation prognosis in the case of Paroșeni Mine using the functional profile the 3D finite element method, Mining Revue No.4 / 2017
- [6]. Floarea, D. A.- Research on the stability of stratified lands and surface objectives in case of exploitation of thick coal seams in the Jiu Valley mining basin, Doctoral thesis, (in Romanian), University of Petroșani, 2017
- [7]. Floarea, DA, Onica, I., Marian, DP- Study of the behavior of buildings located in the area of influence of the exploitation of thick seams of coal in Jiu Valley mining basin, by modeling with 3D finite elements, Annals of the University of Petroșani, Mining Engineering, No.19 / 2018

- [8]. Floarea, I., Onica, DP, Marian, DP- Analysis with 3D finite elements of the stability of the land affected by the underground exploitation, in the Paroşeni mining perimeter, in order to locate a main gas pipeline, Mining Revue, Nr.1/2018
- [9]. Marian, D.P.- Analysis of the surface land stability under the influence of the exploitation of low and medium inclination coal layers in the Jiu valley basin, Doctoral thesis, (in Romanian), Petroşani, 2011
- [10]. Marian, D.P., Onica, I., Cozma, E.- New profile function for ground subsidence assessment in the case of underground coal mining, Revista Minelor, Vol. 17, Nr. 4/2011
- [11]. Marian, D.P., Onica, I., Marian, R.R., Floarea, D.A.- Surface subsidence prognosis using the influence function method in the case of Livezeni Mine, Revista minelor No.1 / 2017
- [12]. Marian, D.P., Onica, I. and others- Study on establishing the causes of the phenomenon of discontinuous subsidence in the Lupeni mining perimeter. Contract no. 1696 APS / 05.12.2018 (in Romanian),
- [13]. Niculae (Marian) Ramona – Rafila- Evaluation of displacements and deformations of surface constructions in the subsidence areas of the Jiu Valley mining basin, Doctoral thesis, (in Romanian), University of Petroşani, 2018
- [14]. Ortelecan, M.- The study of the surface displacement under the influence of the underground exploitation of the deposits from the Jiu Valley, eastern area, Doctoral thesis, (in Romanian), University of Petroşani, 1997
- [15]. Roman Liliana - Analysis of subsidence phenomena occurring in the closed mining perimeters of the Jiu Valley, PhD research report University of Petroşani, 2021(in Romanian),
- [16]. Ştefan, N.- Study of the deformation of the lands under the influence of the underground exploitation of the coal layers from the Jiu Valley mining basin, Doctoral thesis, (in Romanian), University of Petroşani, 2015



## MAKING AND EXPLOITING A GIS DATABASE RELATED TO THE SURFACE MINING AREAS

Vangu Gheorghe Marian<sup>1</sup>, Dima Nicolae<sup>2</sup>

**Abstract:** *Geographic Information System (GIS) is a working technique increasingly used in the contemporary world, both in theoretical research and in many practical activities. GIS is in fact a system that has several informational components related to geographic coordinates. The introduction, storage, manipulation and analysis of components is done by computer, the result of which is the visualization of complex spatial referenced information to real geographic coordinates. The main objective of the presented paper is the realization of a geographic informational system applied to the mining areas in Rovinari – Gorj mining region. Thus, this paper begins by providing general information about GIS (generalities, concepts, definitions) and continuing with the presentation of the stages of GIS. Finally, some aspects of the flexibility and analytical capacity of such a system are presented, thus justifying and demonstrating its usefulness.*

**Key words:** *GIS, mining area, QGIS, ArcGIS, geographic information system*

### 1. GENERALITIES

Geographic Information Systems (GIS) are part of the wider class of information systems. They have as their main characteristic the analysis of the information taking into account its localization or its spatial, geographical location in the territory, by coordinates [3], [4]. GIS technologies arose three decades ago due to the need to facilitate complex geographic analysis operations for which existing systems (CAD, DBMS) did not offer any possibility or required a great deal of time or very difficult procedures.

Although there is often confusion about information systems and IT systems in the current work, a clear distinction needs to be made between these two concepts. At the same time, before defining the components and the functionality of a GIS, the notion of system should be defined.

The system is a set of interconnected elements that act together, as a whole, to ensure that the set goals are met. To understand how a system works, its general features [1], [2], [5] are to be presented.

### 2. CONCEPTS AND DEFINITIONS

Currently, GIS technologies and systems are used in various areas, so there are various definitions of the term GIS. However, all these definitions attempt to

---

<sup>1</sup> *Drd. eng., University of Petroșani*

<sup>2</sup> *Univ. prof. dr. eng., Doctoral School, University of Petroșani*

characterize and describe the same concept: Geographic Information System (GIS).

The purpose and usefulness of geographical information systems are reflected in the various existing definitions. Thus, a GIS can be defined by three perspectives presented in the following table [1], [4]:

**Table 1.** GIS definitions

What a GIS IS	Geographic Information System (GIS) is the information system linking a database that operates with geometrical (spatial) objects with a database that operates with the attributes of the information contained in the prior database.
	GIS is a program package that processes the geographic information contained in maps (treated in spatial, economic and legal terms), couples tabular databases (DBMSs) to graphical information and provides modules for: map editing, multiple criteria queries, graphic selection, multiple database links, development of custom applications that include GIS features.
	GIS is an IT system able to hold and use data describing places on the Earth's surface.
	(Peter Burrough) GIS is a powerful set of tools for gathering, saving, transforming and viewing real world space data.
	GIS is an organized collection of hardware, software, geographic data, and individuals, designed to efficiently capture, store, update, manipulate, analyze, and display all forms of geographically referenced information.
	(Barry Wellar) A GIS consists of software, hardware and peripherals that transform spatially geographically referenced spatial data into location, space interactions, and geographic relationships between static and dynamic entities that occupy space in the natural and built environment.
What a GIS IS NOT	A GIS is not a mapping system, even if it includes these functionalities.
	A GIS does not memorize a map, but stores information about its content (it memorizes the links between spatial data and associated attributes).
	A GIS is not a collection of maps and / or images, but includes a database where it stores information and details to complement the graphic support used in various projects (maps, images).
	A GIS is not a CAD type product.
Role definition	“ <i>What’s on...</i> ” – has the purpose of determining what object exists at a particular location (the location can be described by coordinates, addresses, descriptive data, etc.). Thus, the association between spatial and descriptive data is noticed.
	“ <i>Where is...</i> ” – if in the previous case we started from the hypothesis that the location was known and we had to determine what object was

	there, in this case the data flow is reversed: we know the object of interest and we intend / want to find out his location.
	“ <i>What has changed since...</i> ” – is meant to highlight differences in time (with reference to similar elements – the same object, the same location, etc.).
	“ <i>What spatial model is there?</i> ” – this question applies especially when performing group analyzes based on a spatial model. At the same time, this question aims to highlight the anomalies / exceptions, thus leading to the correction and updating of the spatial model.
	“ <i>Analyzes What If...</i> ” – are questions that underlie various simulations, especially in the case of major investment projects or social impact projects.
	“ <i>Why GIS? Why not CAD?</i> ” – because only GIS products allow the application of efficient space operations on the data. CAD products contain only graphic elements (dots, lines, polygons), while GIS products also contain descriptive elements of them.

### 3. PURPOSE AND METHOD

The main objective of this paper focuses on the design of a geographic information system that integrates various information and various types of data necessary for efficiently organizing and managing the mining activities in the Rovinari – Gorj mining region, from prognosis to post-factum measures. Thus, I intend to design a data model that will form the basis of a geographic information system (a system that will be populated with information of interest) and the use of raster data that will constitute the graphical support of the geographic information system. As a secondary goal (and way to exploit the system), I intend to partially publish the system on a webgis platform, so that the raster graphical support used is represented by opensource maps (GoogleMaps, OpenStreetMap). Publishing on webgis platforms has the role of providing access to information to a diverse range of users and encouraging the transparency of their activities.

### 4. COURSE OF ACTIVITIES

In this case study, I intend to carry out some analysis activities for the correct identification of the needs, and based on the results of this step, a corresponding data model will be generated. This data model will be implemented in three distinct phases: *vectoring of the desired items* using QGIS, *highlighting the exploitation possibilities* using QGIS and ArcGIS (allowing for a comparison of the analytical capability of the two systems), and *publishing on the webgis platform* using QGIS and MangoMap (which allows a comparison of the two platforms).

**Running the Analysis Process:** The main purpose of the analysis process is to first identify the types of the desired information (because I intend to design a flexible data model that can be populated with different types of data) [3].

**Designing of the data model (the database):** is based mainly on the results of

the analysis step. Based on these results a structure and filtering of data of interest, including the elimination of data that is not suitable for the design of a GIS (financial data, budgets, investments, etc.), has been made. The implementation of this data is not blocked, but is left to the system administrator because all this information can be recorded as attributes of traced vectors (existing or future). We opted for an unrelated data model, which allows it to be implemented in any dedicated software product (with relational or non-relational databases). The projected data model can be adapted to achieve a relational model, a model that will work more efficiently (in terms of hardware resource consumption), but will be more difficult to exploit by inexperienced users [3]. This data model can be updated or updated at any time by the system administrator.

**Software resources Selection:** ArcGIS for Desktop software version 10.3.1 was used to implement the case study. (short presentation at: <http://www.esri.com/library/brochures/pdfs/arcgis-desktop.pdf>), QGIS v. 3.4 Madeira (short presentation at <https://qgis.org/en/site/about/index.html>) and MangoMap (short presentation at <https://mangomap.com/>). The three software products were used to perform the following activities:

- QGIS: accessing raster graphical resources, vectoring the desired items, performing content analyzes, publishing the project on the webgis platform;
- ArcGIS: performing content-based analysis, generating thematic maps;
- MangoMap: publishing the project on the webgis platform.

Given that publishing on webgis platforms with raster open source support is being pursued, all operations are performed in the WGS84 / Pseudo-Mercator reference system [5]. All the elements projected into the project can then be translated into other reference systems, as required.

**Drawing / Vectoring of Elements of Interest (Polygon, Line, Point):** Primary vector types (point, line, polygon) [2], [3], [5] were used to vector the desired elements.

- **point** vector: is represented by a single coordinate pair X, Y; can be used to represent the outdoor lighting network (pillars), the sewer network (canopy / drainage channels), grounded points, points of interest, etc.;
- **line** type vector: it is represented by an ordered pair of X, Y coordinate pairs; can be used to represent the conveyor belts, street and alley network, utilities networks (water, natural gas, electricity, telephony / data), marking indoor access ways, marking access roads in buildings, marking routes to follow in various scenarios thing etc.;
- **polygon** vector: is represented by a series of coordinate pairs X, Y that define the linear segments that fit the polygon; can be used to represent enclosures, buildings, parking lots, green spaces, stairs, storage platforms, bank areas, landscapes and landscaping, culture elements, etc.

Basically, the project's specialized activities were as follows:

**A. Using QGIS**

- a. *Ensuring raster layer support* by connecting to data sources: In the Browser panel – the XYZ Tiles section, a new connection is created, specifying the name, the link to the public resource and the authentication data (if it is applicable).

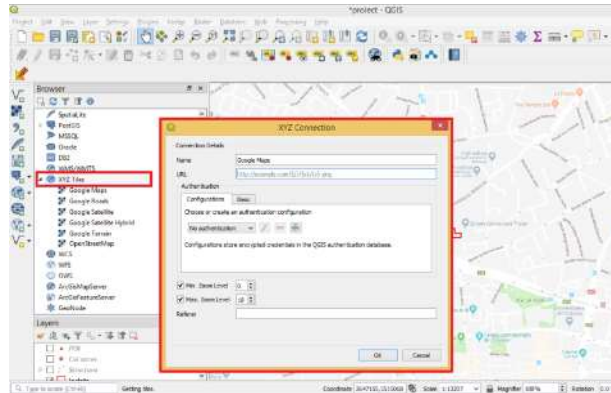

**Figure 1.** Adding the link to the external data source

For the case study presented, links to the following resources have been added:

- Google Maps: <https://mt1.google.com/vt/lyrs=r&x={x}&y={y}&z={z}>
- Google Satellite: <http://www.google.cn/maps/vt?lyrs=s@189&gl=cn&x={x}&y={y}&z={z}>
- Google Satellite Hybrid: <https://mt1.google.com/vt/lyrs=y&x={x}&y={y}&z={z}>
- Google Roads: <https://mt1.google.com/vt/lyrs=h&x={x}&y={y}&z={z}>
- OpenStreetMap: <http://tile.openstreetmap.org/{z}/{x}/{y}.png>

- b. *Vectorization of the desired elements* [7]: the vectorizations were made on Rovinari – Gorj surface mining areas. In QGIS, adding vector graphics is done by accessing New Shapefile Layer (from the Layer menu -> Create Layer or from the Manage Layers toolbar). When accessing this option, a graphical form in which the resource name (thematic layer) is specified, the location in which the resource is saved, the vector type (point, line, and polygon) and the reference system are selected. At the same time, it is possible to configure attributes related to the thematic layer, attributes whose values will be completed at the time of vectoring. The list of attributes and values can also be configured from the configuration layer properties of the thematic layer.

For the presented case study, a series of point, line, polygon, elements were configured, and values (as well as their values) were set up as shown in Tables 2 and 3.

**Table 2.** Examples of vectorized elements

Thematic layer name	Vector type	Number of vectorized elements
Mining area	Polygon	10
ConsumptionUnit	Polygon	1
POI (Points of interest)	Point	4
TransportCtrl	Point	7
Transportation	Line	7

**Table 3.** Examples of vectorized elements structure

Thematic layer	Name	Type	Length	Details
Mining area	Id	int		Unique identifier
	Active (YES/NO)	varchar	2	Current status
	Q	numeric	15,3	Production
	DataStart	date		Start date for mining operations
	Area	numeric	10,3	Area
	Perimeter	numeric	10,3	Perimeter
Transport	Id	int		Unique identifier
	Code	varchar	20	Internal coding
	Length	numeric	20,3	Length
	Type	varchar	35	Conveyor belt type
Enclosure	Id	int		Unique identifier
	Location	varchar	255	Location address
	Perimeter	numeric	10,3	Perimeter
	Area	numeric	10,3	Area

In Figure 2, some vectorized elements can be viewed (base map is Google Maps), as well as their representation mode: the enclosure (red line, transparent background), mining areas (black line, orange background), conveyors belt (black line).

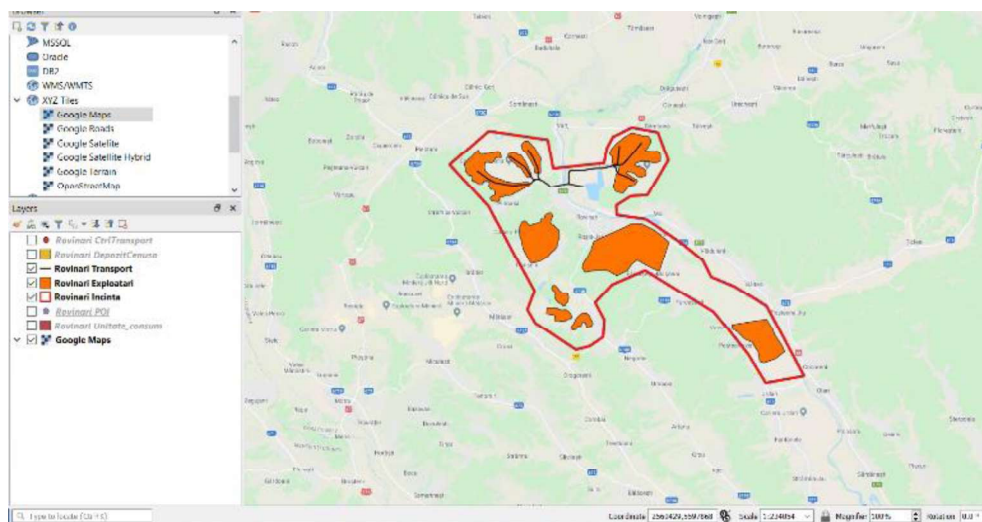

**Figure 2.** Visualizing the vectorized elements

Based on an open data model, the system can be developed and enhanced by adding new thematic layers and vectoring new items of interest such as: internal operating networks, positioning work equipment, deposits positioning (ore, heaps etc.),

work zone, operating zones etc.

- c. *Configuration of thematic layers [7]:* The QGIS software allows you to configure the thematic layer details as needed. The Thematic Layer Detail Setup window can be accessed from the thematic layer that you want to set up (double-click on the thematic layer, or right-click and select Properties), and some of the most common sections are as follows:
  - Source: view and / or change the thematic layer name and reference system
  - Symbology: includes features to configure the visual layout of the thematic layers. Various visual presentation modes (Figure 3) were used in the case study, such as: *single symbol* for representing the thematic layer *Transport*; *categorized* to represent the thematic layer *Mining area* by the size of the area etc.

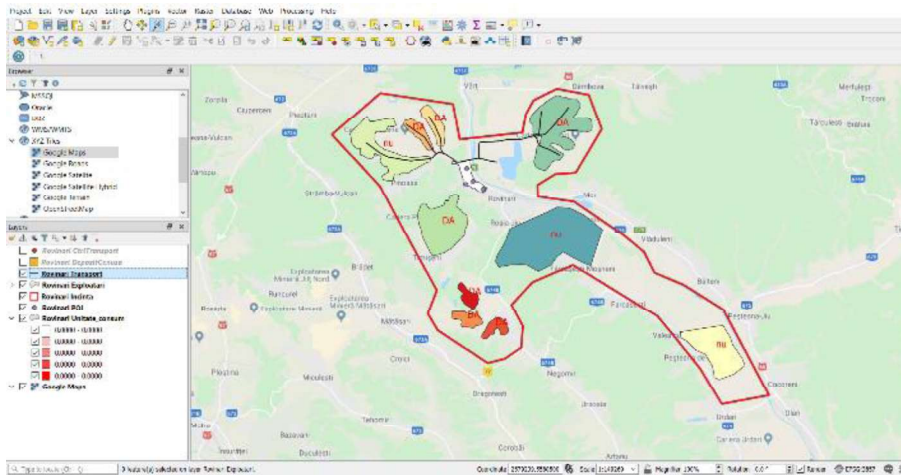

Figure 3. Example of visual representation of thematic layers

- Labels: allows you to configure the labels to be displayed (text formatting, visual formatting, displaying simple or complex labels, etc.). For example, this feature has been used to display labels associated with the *MiningArea* thematic layers, the label representing the size of the mining area (Figure 3).
- Source fields and Attributes Form: allow (re)configuration and formatting attributes for the selected theme layer. Within this section, you can add, modify or delete attributes, but you can also configure computational formulas for specific fields. For example, computational fields containing lengths and arrays (*Transport* thematic layer, *Length* field, *MiningArea* thematic layer, *Area* and *Perimeter* fields) have been configured in the presented case study.
- Actions: allows you to configure certain predefined actions associated with the vectorized elements. The case study included actions for accessing documents associated to POIs (thematic layer *POI*).

- d. *Analytical capacity of the system [7]:* Given that a GIS has to respond to a variety of issues, it must provide a great deal of flexibility in recording, storing, searching, retrieving, processing and presenting information of interest.
  - o *The application of content-based filters:* The easiest and fastest way to analyze spatial data is to display thematic interest layers and apply filters based on attribute content (attribute values) or the creation of subsets of data based on queries. In QGIS, the content-based query setup screen can be accessed in a number of ways: right-click on the theme layer and then select Filter in the theme layer properties window and then the Source

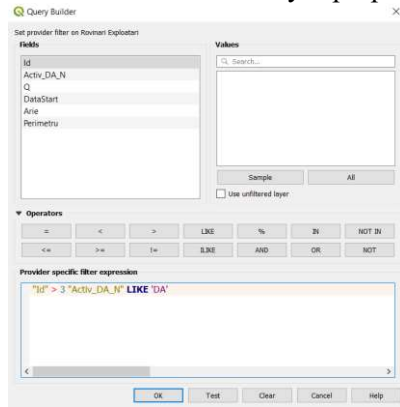

Figure 4. Filtering criteria

section – the Query Builder button or the Layer menu, and then the Filter option. The filtering form is in fact an interface for constructing content-based expressions, as can be seen in Figure 4, where a data selection expression based on id (> 3) and of the mining area status (Active = 'YES') of the MiningArea thematic layer.

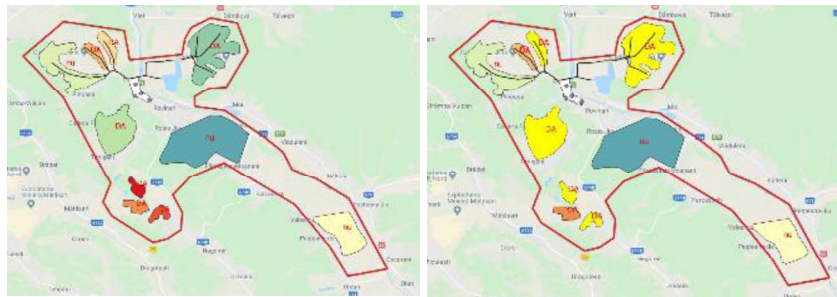

Figure 5. Unfiltered data, filtered data (yellow background)

- o *filtering in the attribute table:* the table of attributes allows tabular viewing

id	Activ DA N	DataStart	Arie	Perimetru
1	DA	625257575		
2	DA	677453678		
3	DA	757825177		
4	DA	825032654		
5	DA	7649175288		
6	DA	4464706232		
7	DA	565852375		

Figure 6. Filtering the attribute table

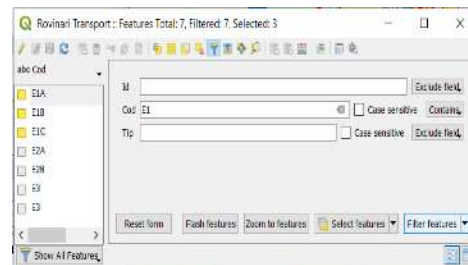
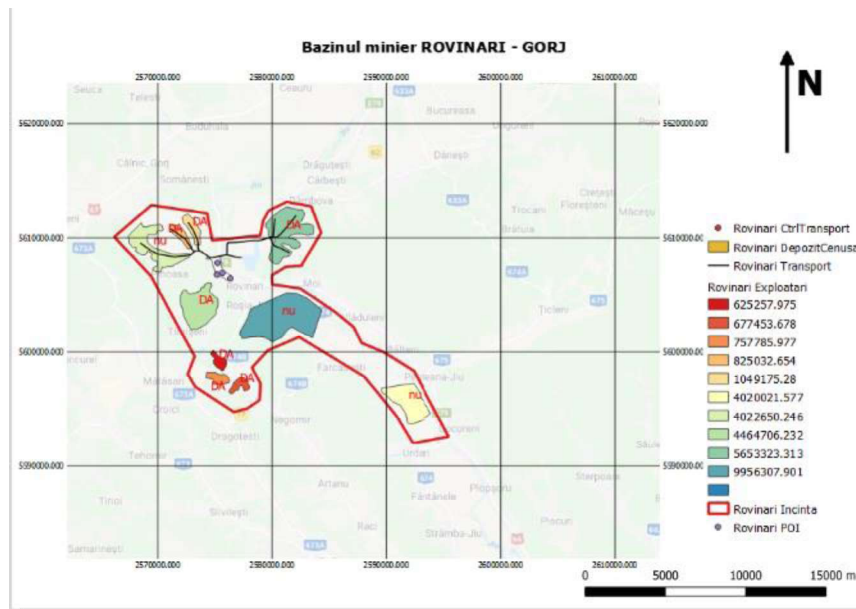

Figure 7. Filtering the attribute table



of values and their quick filtering based on the content of a thematic layer (Figure 6 shows the filtering by mining area status), but has the disadvantage of a graphical interface difficult to use for inexperienced users, especially when applying complex filters, as can be seen in Figure 7.

- *Dynamic measurements*: Through the Attributes toolbar, QGIS includes dynamic measurement facilities for lengths, surfaces and angles. When using these tools, the user has the ability to configure the display parameters, such as: the units of measurement, the color and thickness of the tracer vector, etc.
- *building thematic maps*: QGIS allows the building of thematic maps based on the vectorized elements. Thus, in the window of generating thematic maps, you can add and configure all the required elements of a map: the content, the title, the grid, the scale of representation, the legend and the north direction, as can be seen in Figure 8.



**Figure 8.** Example of thematic map

- e. *Exporting vectorized items for later use in other specialized software products*: vectorized items can be exported as .shp files, allowing them to be used in other specialized software products. Export is done by going to the Layer menu and then clicking Save as. The open window specifies the format in which the resources will be exported, the location and file name, and the coordinate system attached.
- f. *Publishing the project on the webgis platform [7]*: To give access to information to a diverse range of users, the project was published on the QGIS Cloud webgis platform. The publication of the project was accomplished through the following stages:
  - *Installing and configuring the Component QGIS Cloud Plugin* – component that allows the local project connection with online publishing servers and

- services. Installing this component was done by selecting *Manage and Install* Plugins from the *Plugins* menu. After installation, you need to configure the server address for publishing, in this case <https://api.qgiscloud.com>
- *Preparing the publishing project* – involves displaying and localizing the thematic layer exactly as it is intended to be published. For the presented case study, the following thematic layers were made:
    - *POI* thematic layer: setting the representation symbol and displaying the name as a label
    - thematic layer - *Transport*: setting the representation symbol
    - thematic layer - *Enclosure*: setting symbol for representation
    - thematic layer - *MiningArea*: gradual representation according to the area size (color palette) and label display composed of the phrase “Area” and values of the Area attribute
    - available background maps: Google Maps, Google Satellite, Google Satellite Hybrid, OpenStreetMap
  - *Creating the database and uploading files*: To create a database, go to the Plugins, Cloud, Cloud settings menu. After creating the database, it is necessary to upload the thematic layers that will be available on the webgis platform. For the present project, all the thematic layers mentioned in the previous paragraph were loaded. After uploading the files, the project can be published online by accessing the PublishMap option, the time it is generated and the link to access it. The map published for this case study can be accessed at: <https://qgiscloud.com/marianv/rovinari/>.

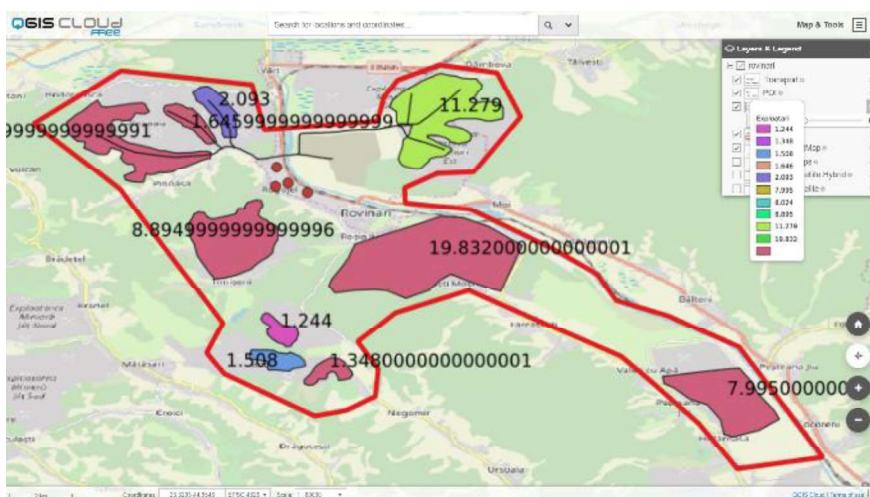

Figure 9. Project published on the QGIS Cloud platform

- *Using the published map*: The QGIS Cloud platform provides features which enable / disable thematic layers for viewing, legend viewing, map navigation, changing the background map, measuring tools (length, area, angle to north direction), viewing values attributes for the selected item, etc.

Figure 9 shows some of these features.

- *Advantages and Disadvantages QGIS Cloud:* This platform has the benefits of free publishing (with limitations in storage capacity and the number of published databases) and using it is easy and intuitive, but has the major disadvantage that it does not allow configurations in the online environment (any necessary reconfiguration needs to be done locally, and the map needs to be republished later).

### B. Using ArcGIS

In order to demonstrate the analytical capabilities of the GIS systems as well as the portability of resources, the content analysis and the use of ArcGIS v. 10.3.1. have been performed within the project. Thus, resources previously exported from QGIS have been downloaded into ArcGIS (using the Add data option), which is the support for a series of analytical procedures. When retrieving resources in ArcGIS, we can notice that they do not contain the formatting details existing at the time of export (symbols, visual presentation, etc.), which means they need to be reconfigured according to the needs and capabilities of the software used. From these we present [3], [6]:

- *Analysis based on 2D thematic maps:* The 2D-themed maps are used to graphically / visually represent the content elements from the list of attributes associated with the vectorized elements. For example, we have generated a 2D Thematic Map that graphically shows the mining areas according to the *area size*. In this regard, we have accessed the list of properties of the layer of interest (MiningArea), a list that we specified: representation mode, reference field / attribute, number of intervals, interval limits, etc.

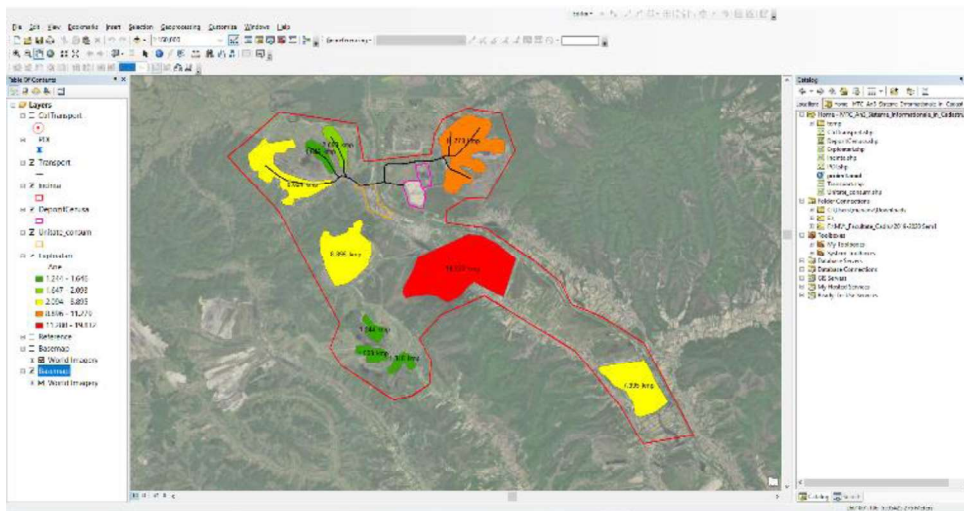

Figure 10. 2D thematic map – mining area

- *Analysis based on 3D thematic maps:* Thematic 3D-type maps are used to graphically / visually represent content items starting from the list of attributes associated with the vectorized elements. For example, we've generated a 3D themed map that graphically shows mining areas that are structured according to their total area size.

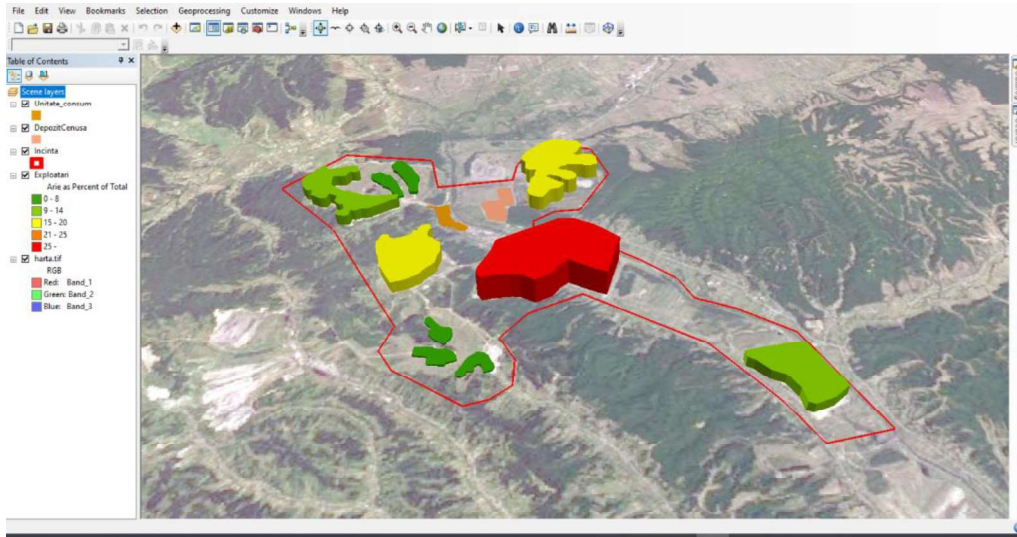

Figure 11. 3D thematic map

- Queries “By Attributes” and “By Location”*: In a spatial database, searches of elements that meet certain requirements in accordance with user interest can be done by two criteria: location of the relevant elements (absolute, relative) and attribute (features of the search items, which are stored in the attribute table). In order to exemplify “By Attributes”, we will make a selection based on the attributes. Thus, we aim at selecting mining areas that have Active status and which have at least 2 square km.

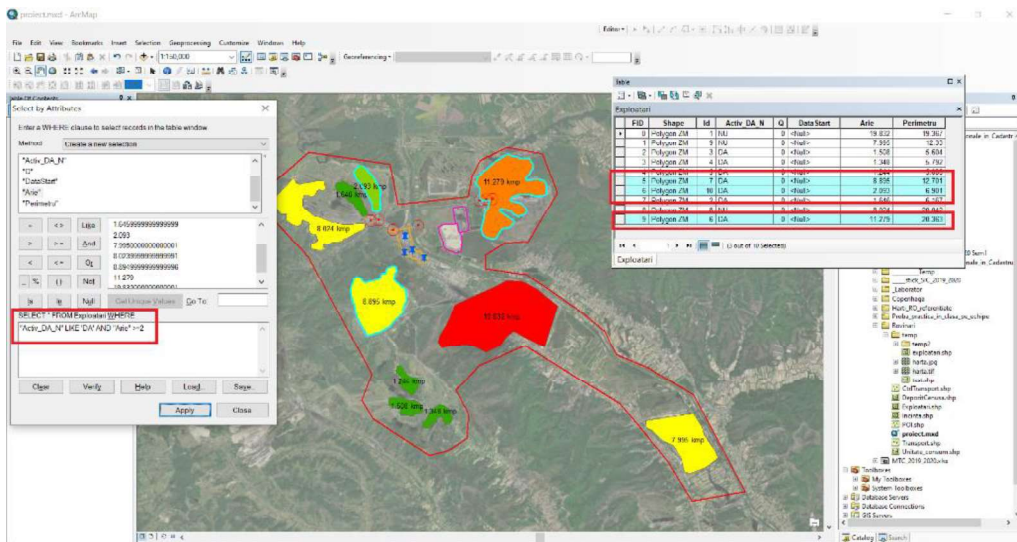

Figure 12. Query “By Attributes”

At the same time, to exemplify “By Location” queries, we aim to identify mining areas that have Active status and which have at least 2 square km (starting from the previous search based on attributes) and which are at a maximum of 1250 m away from the consuming points.

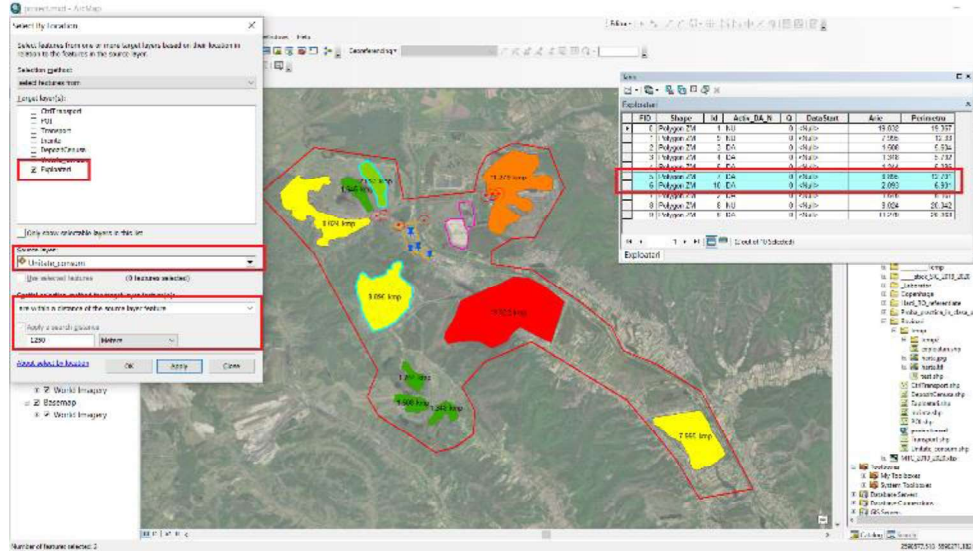

Figure 13. Query "By location"

- *Data presentation in graphical form:* The graphs show the table information in a graphical form. In ArcView, charts are permanently linked to tables and maps. This means that a record in the attribute table you want to represent graphically will have to be selected with one click. At the same time, information can be obtained directly from the graph. ArcView has the ability to work with seven types of graphics: area, bar, line, pie, bubble, polar and dispersion (x, y scatter). Users have the ability to modify how information is presented as needed, and then have the ability to include graphics created in the Layout for printing and publishing. For example, we present a pie chart showing the mining area surface (figure 14).
- *Using Hyperlink and HTML Popup Elements (Figure 14):* Geographic Information Systems are a collection of data that can be stored and accessed in a number of ways, depending on how they are stored. Thus, data may be presented as a result of queries applied directly to data collections or as a result of accessing external information sources (hyperlinks). In this way, any vectored elements can be attached to external references that can provide additional information regardless of their type: descriptive data, images, etc.

For example, in the case study we have attached a hyperlink for the Complexul Energetic Oltenia website. Interest information can also be presented as popup HTML windows. These elements are in fact standard HTML windows where you can present various memorized information about the vectorized elements. In the HTML Popup windows, descriptive data, images, links, etc. can be displayed simultaneously

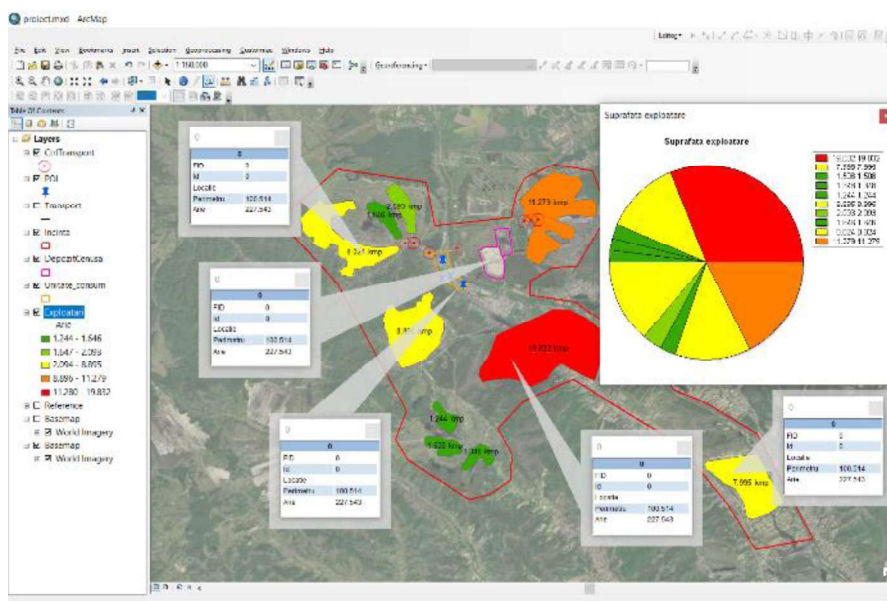

Figure 14. Presenting data as graphs, Hyperlink, HTML Popup

- *Data presentation in MAP LAYOUT form* (figure 15): ArcMap offers two different ways to view a map:
  - **data view** – is a view mode used to explore, display, or query data; is the default way to open the app
  - **layout view** – a layout is a collection of elements of a map (title of the map, legend, scale, reference system, etc.) positioned and organized on a virtual page before plotting / printing.

Data presentation in Layout view allows you to configure the required elements before plotting / printing. Thus, users have the option of adding mandatory elements to maps and plans:

- **grid illustration**: Select the frame that fits the map and access its properties list
- **North direction insertion**: access the Insert -> North Arrow option, select the pattern and possibly configure its properties
- **Insert Legend**: Access the Insert -> Legend option and fill in the required details
- **Insert Scale Bar**: access the Insert -> Scale Bar option and fill in the required details

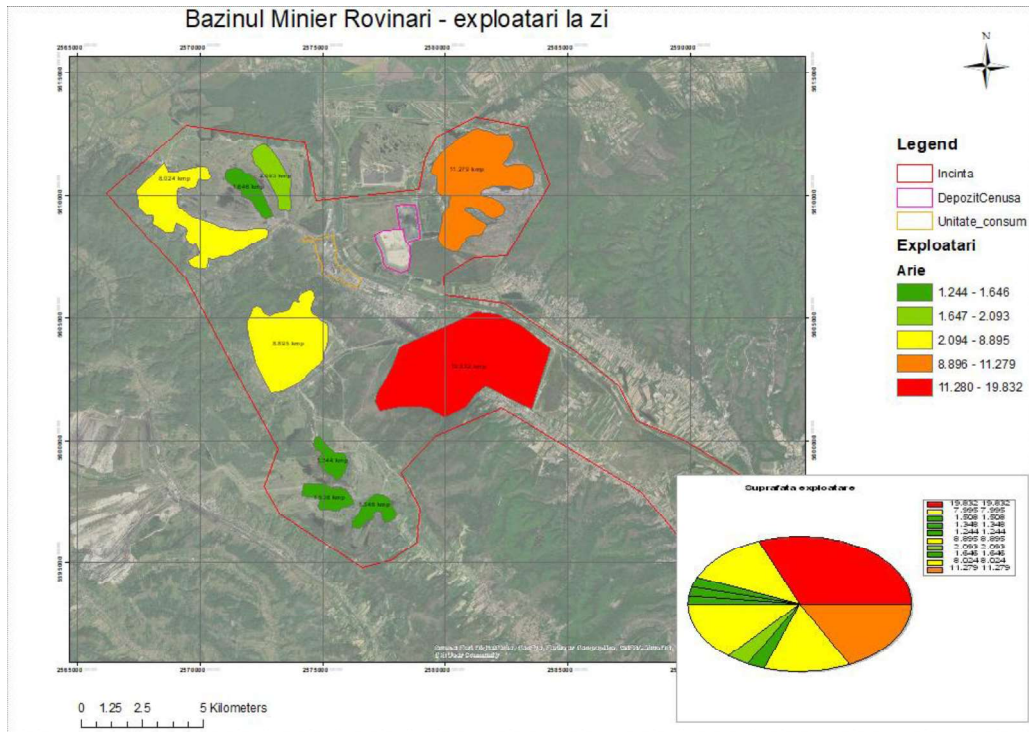

Figure 15. Introducing a map with configured mandatory elements (grid, legend, north direction, scale bar)

### C. Using MangoMap

The presented case study was also published on the MangoMap webgis platform. This platform is a commercial one, so it has both advantages and disadvantages. The main advantage of this platform is how to configure the visual presentation of the project (activating or inactivating sections and working tools, positioning and navigation facilities, measurement facilities, grouping and organizing thematic layers, configuring symbols and labels, managing access to the project, project sharing facilities, etc.), all of which can be set up within the platform without being dependent on other GIS software (only specific data such as .shp is required). The main disadvantage of the platform is the high cost of publishing the projects. Even if there is a free publication of the project for a trial period (maximum 30 days), this platform does not offer free publishing facilities with or without imposing technical limitations.

Figure 16 shows how to publish the case study (<http://mgo.ms/s/pi74k>). Thus one can notice:

- The possibility of displaying thematic layers (MiningArea, Enclosure, AshPile) with the symbols associated with the project configuration within the platform
- possibility to change the background map (there are 9 default background maps)
- instruments for measuring areas and distances
- ability to view values associated with attributes, etc.

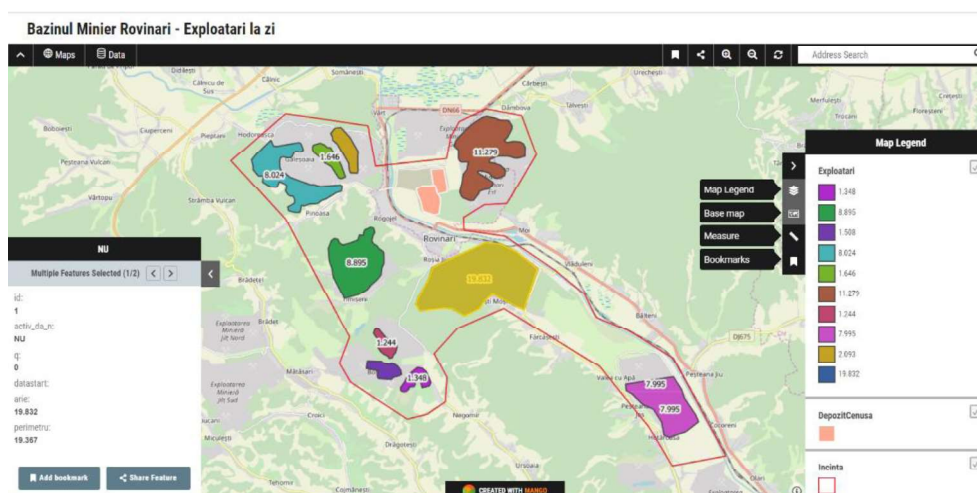

Figure 16. Project published on the MangoMap platform

## 5. CONCLUSIONS

The rapid evolution of information technology has various influences on all areas of activity, so implementing decision support systems has become a necessity. As a peculiarity of these systems (and of information systems), by highlighting the localization information of the various elements, the geographical information systems were created. They find their place in all areas of activity where spatial information is used.

It should be noted that the basic entity of a geographic information system is the location (geospatial data), and the graphic representation is done by raster (as a graphic support) and vector type (to delineate the elements of interest).

Based on these aspects, based on the case study, the following conclusions can be drawn:

- the geographic information system is a dedicated tool for both management and executives;
- any geographic information system must have a high degree of flexibility so that it can be configured as needed at the time of implementation;
- designing and implementing a geographic information system involves the development of a data model (database structure);
- the design of the data model can only be carried out after carrying out the needs analysis activities;
- the implementation of a geographic information system requires the existence of a graphic support (raster type);
- the structure and content of a geographic information system can be updated at any time (with greater or lesser efforts and, of course, awareness of all subsequent implications);
- a geographic information system allows displaying and extracting results in various forms: images, graphs, tables, maps, etc .;



- a geographical information system provides flexibility in analyzing data of interest;
- the system information can be accessed locally or by publishing on webgis platforms;
- there is the possibility of porting data between different software products;
- even if specialized software products offer different data presentation facilities, the operating principles are the same;
- there are variants of free or charged implementation of projects, depending on needs and possibilities;
- GIS projects are constantly updated and developed to meet current needs.

## 6. REFERENCES

- [1]. Băduț, M., GIS – Sisteme Informatice Geografice, fundamente practice, Editura Albastră, Cluj-Napoca, 2007
- [2]. Burrough, P.A., Principles of GIS, Longman Academic Press, London, 1993
- [3]. Călina, J., Călina, A., Bădescu, G., Vangu, G.M., Ionică, C.E., Research on the use of aerial scanning for completing a gis database, AgroLife Scientific Journal – Volume 7, Number 1, pag.25-32, University of Agronomic Sciences and Veterinary Medicine of Bucharest, Bucuresti, 2018
- [4]. Dimitriu, G., Sisteme Informaționale Geografice, Editura Albastră, Cluj Napoca, 2001
- [5]. Georgescu, D., Realizarea unui sistem informațional geografic al cadastrului drumurilor și lucrărilor de artă aferente, Editura Universității Al. Ioan Cuza, Iași, 2004
- [6]. \*\*\*, <http://desktop.arcgis.com/en/arcmap/latest/map/main/mapping-and-visualization-in-arcgis-for-desktop.htm>
- [7]. \*\*\*, [https://docs.qgis.org/2.18/en/docs/user\\_manual/](https://docs.qgis.org/2.18/en/docs/user_manual/)



## ANALYSIS OF THE STABILITY OF THE ROOMS AND RESISTANCE STRUCTURES AT THE OCNELE MARI – COCENEȘTI SALT MINE, BASED ON SAFETY FACTOR

**Marian Dacian-Paul<sup>1</sup>, Onica Ilie<sup>2</sup>**

**Abstract:** *The exploitation of the rock salt deposit from Ocnele Mari Salt Mine, with small square rooms and pillars, started in 1956, at the levels of +226 m and +210 m, and now continues on the horizon +190m. This article presents a check of the stability of the rooms, pillars and ceilings between levels, based on safety factor, calculated using analytical methods and obtained from numerical models with finite element. Following the analysis of the safety factors, it was found that the resistance structures of the Ocnele Mari Salt Mine have a relatively good stability, at least during the mining period of each level.*

**Keywords:** *rock salt, rooms and pillars mining, analytical methods, numerical models, finite element, stability, safety factor*

### 1. INTRODUCTION

The salt deposit from Ocnele Mari has the shape of a lens, with the dimensions of approx. 7.5 km (E-W), and 3.5 km (N-S) and variable thicknesses, with a maximum value of 450 m, in the central part of the lens (Hirean & Georgescu, 2012; Marica, 2011).

The exploitation of the deposit started in 1996 by the underground mining method with small rooms and square pillars (Covaci et al., 1999), with the geometric parameters presented in table no.1.

**Table 1.** Geometric parameters of the mining method with small rooms and square pillars, for the designed levels from Ocnele Mari - Cocenești Saline

Horizon	Starting year of exploitation	Mined reserve, tonnes	Room		Pillar		Ceiling	Level
			Width, W/ E [m]	Height, [m]	Width, W/E [m]	Height, [m]	Thickness, [m]	Height, [m]
+226m	1996	1066	16/15	8	14/15	8	8	16
+210m	2001	2264	16/15	8	14/15	8	8	16
+190m	2021	2365	15	8	15	8	12	20

Due to the land configuration, the depths of the exploitation levels are variable and the calculated geostatic natural stresses (Herget, 1988) at these horizons are

<sup>1</sup> *Assoc.Prof.PhD.Eng.* University of Petroșani, Romania, dacianmarian@upet.ro

<sup>2</sup> *Prof.Habil.PhD.Eng.* University of Petroșani, Romania, onicai2004@yahoo.com

different (table no.2) and differently influence the stability of mining excavations and resistance structures (pillars and ceilings). This is also the reason why, for the two sides (east and west) of the deposit, pillars with different sizes were designed (larger in the east side of the deposit, where the elevations of the land reach the value of  $Z = 350-360$  m, compared to  $Z = 300-310$  m, in the west).

**Table 2.** Variation of natural stresses and at the level of the floor of the designed horizons

Horizon	Depth, $H$ , m		Vertical stresses, $\sigma_v, \cdot 10^4$ N/m <sup>2</sup>		Horizontal stresses, $\sigma_h, \cdot 10^4$ N/m <sup>2</sup>	
	max.	min.	max.	min.	max.	min.
+226m	135	75	290.25	161.25	72.56	40.31
+210m	151	91	324.65	195.65	81.16	48.91
+190m	171	111	367.65	238.65	91.91	59.66

As in the case of the other salt mines in Romania exploited over time, for the dimensioning of the rooms, pillars and ceilings of the Ocnele Mari Salt Mine, several analytical calculation procedures known from the specialized literature were used (Stamatiu,1962; Hirean,1981; Popescu&Todoreescu,1982; Hirean&Georgescu, 2012). As this is a mine already in exploitation, analytical and numerical methods for calculating the safety factors were used in this work, only to verify the degree of stability of these resistance structures. The main average geomechanical characteristics of the rock salt and the surroundings rocks, used in the analytical and numerical calculations, are summarized in table no.3.

**Table 3.** The main average geo-mechanical characteristics of the massif of rock salt and surrounding rocks (Onica et al., 2011)

Characteristic	UM	Value	
		<i>Rock salt</i>	<i>Surrounding rocks</i>
Apparent specific weight, $\gamma_a$	kN/m <sup>3</sup>	21.5	19
Modulus of elasticity, $E$	kN/m <sup>2</sup>	1,500,000	700,000
Poisson's ratio, $\nu$	adim.	0.25	0.22
Compression strength, $\sigma_c$	kN/m <sup>2</sup>	21,700	4,000
Tensile strength, $\sigma_t$	kN/m <sup>2</sup>	1,200	500
Shear strength, $\tau_f$	kN/m <sup>2</sup>	2,300	-
Cohesion, $C$	kN/m <sup>2</sup>	4,000	1,000
Internal friction angle, $\varphi$	°	30	18

The verification of the stability of the excavations in the salt mines must be oriented towards the establishment of the dimensions of the rooms, of the pillars and of the ceilings, respectively towards the knowledge of the stability reserve. Also, the notion of stability defines such a state of the system, in which a safe and sustainable balance is maintained, with the maintenance of the designed section of the underground excavation, in full safety conditions, for its entire use (Hirean & Georgescu, 2012). A synthetic indicator of the stability reserve (according to a certain criterion) is the safety factor, determined under the conditions of analytical or numerical calculation assumptions.

## **2. ANALYTICAL METHODS FOR CALCULATING SAFETY FACTOR**

The main objective of the calculations in rock mechanics is to determine the response of the rock mass to stresses, which can be produced by certain efforts generated on the rock mass or by changing the geometry of the mass, by making excavations inside it, on ground or underground.

Changing the geometry of the rock mass produces a change in the natural state of stresses and strains, with the effect of breaking and slipping slopes, in the case of open pit mining or deformation and fracturing of rocks around underground excavations, in the case of underground mining.

The calculation methods in rock mechanics can be: a) based on the hypothesis of the continuity of the rock massif; b) taking into account the discontinuities of the environment.

When it is assumed that the rock mass is continuous, simple problems can be solved by using analytical methods specific to the case studied.

Continuous media mechanics hypotheses are widely used in modeling various rock engineering problems due to the simplifications introduced in the construction and analysis of these models. The main hypotheses of the mechanics of continuous media, in elasticity, are the following (Onica & Marian, 2016):

1) matter is solid and continuous - the physical properties and state functions of the environment are continuously and continuously derivable in all its points;

2) the environment is homogeneous - the behavior of the environment is identical in all its points;

3) the environment is isotropic - it behaves identically in all directions;

4) the solid is perfect: the environment must respect the hypothesis of "small deformations" and "small displacements" (inside the environment subject to transformation there is no shearing or detachment);

5) elasticity hypothesis - the behavior of the environment is characterized by a linear relationship between stresses and strains;

6) possible additional hypotheses based on the previous hypotheses, such as: the hypothesis of plane deformation, symmetry of revolution, plane stresses, etc.

Table no. 4 summarizes a series of analytical methods, based on different assumptions for calculating safety factors. The analytical methods developed by different authors are taken from the work (Hirean & Georgescu, 2012). These safety

factors were calculated to analyze the stability of the rooms (in terms of their length and width) and the stability of the pillars and ceilings between the levels.

**Table 3.** Analytical methods for calculating safety coefficients for assessing the stability of rooms, pillars and ceilings from the Ocele Mari Salt Mine

Author/Hypothesis	Calculation formula of safety factor	Calculation parameters	Safety factor
<b>A) Stability of rooms</b>			
<i>A.1. Width of rooms</i>			
<b>W.Ritter</b> The weight of the rocks in the equilibrium vault should be balanced by the cohesive forces	$n = \frac{4 \cdot \sigma_{rt}}{L_c \cdot \gamma_a}$	$\sigma_{rt}$ - tensile strength; $\gamma_a$ - apparent specific weight; $L_c$ - room width.	$L_c=16m$ $n=14$
<b>M.M.Protodiakonov</b> Hypothesis of the pressure vault, in which the rock is homogeneous, without cohesion	$n = \frac{9,5 \cdot \sigma_{rt}}{L_c \cdot \gamma_a}$	$\sigma_{rt}$ - tensile strength; $\gamma_a$ - apparent specific weight; $L_c$ - room width.	$L_c=16m$ $n=33$
<i>A.2. Length of rooms</i>			
<b>H. Borger</b> The walls of a mining room should not collapse under the weight of the overlying rocks	$n = \frac{2 \cdot \sigma_{rf}}{\gamma_a} \cdot \left( \frac{1}{L} + \frac{1}{L_c} \right)$	$\sigma_{rf}$ - shear strength; $\gamma_a$ - apparent specific weight; $L$ - room length; $L_c$ - room width.	$L=1300m$ $L_c=16m$ $n=13.53$
<i>A.3. Height of rooms</i>			
<b>C.A.Coulomb-G.Rebhann</b> <u>Hypothesis 1</u> The pressure exerted by the mass of rock salt perpendicular to one of the walls is equal, at the limit, to the tensile strength of the rock salt	$n = \frac{\sigma_{rt}}{h \cdot \gamma_a}$	$\sigma_{rt}$ - tensile strength; $\gamma_a$ - apparent specific weight; $h$ - room height.	$n=7$
<u>Hypothesis 2</u> The pressure of the equilibrium parabolic vault causes the walls to slide along inclined surfaces	$A = \frac{36 \cdot \sigma_{rt}}{\gamma_a \cdot h}$ $B = \frac{74,5 \cdot \sigma_{rt} \cdot (1,1 \cdot \sigma_{rf} - \sigma_{rt})}{\gamma_a^2 \cdot h^2}$ $n = \frac{-A + \sqrt{A^2 + 4 \cdot B}}{2}$	$\sigma_{rt}$ - tensile strength; $\sigma_{rf}$ - shear strength; $\gamma_a$ - apparent specific weight; $h$ - room height.	$n=15$

<b>B) Stability of pillars</b>			
<p><b>L.D. Ševiakov</b> The weight of the rock column above the pillar is compensated by the compressive strength of the pillar</p>	$n = \frac{\sigma_{rc}}{\gamma_{as} \cdot H \cdot \left[ \left( 1 + \frac{L_c}{L_p} \right)^2 + \frac{\gamma_a \cdot h}{\gamma_{as} \cdot H} \right]}$	<p><math>L_p</math>- pillar width; <math>L_c</math>- room width; <math>H</math>- surface depth; <math>h</math> - room height.</p>	<p>for <math>L_c=15m</math> <math>n=1.66</math></p>
<p><b>V.V.Sokolovsky- K.V.Ruppeneit</b> The effective stresses in the pillars must be lower than their failure strength</p>	$\sigma_{ef} = \left( 1 + \frac{L_c}{L_p} \right)^2 \cdot \gamma_a \cdot H - \left( \sum h_c + \sum h_{pl} \right) \cdot \gamma_{as} \cdot (1 - \eta)$ $\sigma_{lim} = \frac{C_m}{\alpha} \cdot \left\{ 2 + \left[ 1 - \frac{1}{\alpha} \cdot \operatorname{tg} \left( \frac{\pi}{4} - \frac{\varphi}{2} \right) \right] \cdot [2 + F(\alpha, \varphi)] \right\}$ $n = \frac{\sigma_{lim}}{\sigma_{ef}} = \frac{1}{\Delta}$	<p><math>L_p</math>- pillar width; <math>L_c</math>- room width; <math>H</math>- surface depth; <math>h_c</math>- room height; <math>h_{pl}</math>- ceiling thickness; <math>\sigma_{ef}</math>-effective stress; <math>\sigma_{lim}</math>-limit failure strength of pillars; <math>C_m</math> - the apparent cohesion of the massif; <math>F(\alpha, \varphi)=21</math>; (<math>\alpha=1.87</math>); <math>\eta</math> - mining coefficient.</p>	<p><math>\Delta = 0,174</math> <math>n = 5.32</math></p>
<p><b>M. Stamatiu</b> The hypothesis is based on the determination of the resistance of prismatic samples with a square base</p>	$L_p = h \cdot \left[ \left( \frac{\gamma_a \cdot H}{\sigma_{rc}} \right)^2 + 2 \cdot \operatorname{ctg} \psi \right]$ $\psi = 45^\circ + \frac{\varphi}{2}; \quad n = \frac{L_{pr}}{L_p}$	<p><math>L_p</math>- pillar width; <math>L_{pr}</math>-real pillar width; <math>H</math>-depth; <math>h</math> – pillar height.</p>	<p><math>n=2.22-2.55</math></p>
<b>C) Stability of ceilings</b>			
<p>Ceilings assimilated to embedded plates</p>	$n = \frac{B \cdot a \cdot h_p^2 \cdot \sigma_{rt}}{L_c^2 \cdot (\gamma_a \cdot h_p + q_s)}$	<p><math>B=3.22</math> (for square plates); <math>a=1.3</math> (for rock salt); <math>L_c</math>- room width; <math>q_s=57kN/m^2</math> – supplementary loading;</p>	<p>for <math>h_p=8m</math> <math>n = 5.48</math>; for <math>h_p=12m</math> <math>n = 10.21</math>.</p>
<p>Ceilings loaded to the shearing</p>	$\tau_{lim} = C \cdot \frac{1}{K_i} \cdot \frac{\cos \varphi}{1 - \sin \varphi} + \frac{\sin \varphi \cdot \cos \varphi}{1 - \sin \varphi} \cdot \gamma_a \cdot h_p$ $\tau_{\max M} = \frac{3}{2} \cdot \frac{\xi \cdot q \cdot d}{h_p}$ $n = \frac{\tau_{lim}}{\tau_{\max M}}$	<p><math>\tau_{lim}</math> - the limit shear strength of the ceiling; <math>\tau_{\max M}</math> - the maximum shear stress at the midpoint; <math>K_i=1.08</math>- coefficient</p>	<p>for <math>h_p=8m</math> <math>n = 14.15</math>; for <math>h_p=12m</math> <math>n = 16</math>.</p>

		of reduction of resistance parameters; $d=30\text{m}$ – the distance between the ceiling supports; $q$ - total specific load on the floor; $\xi = 0.36$ - coef. depending on the width of the "room-pillar" system	
--	--	---	--

Analyzing the values of the safety factors summarized in table no.4, calculated with different analytical procedures/methods, for rooms, pillars and ceilings, it can be seen that most safety factors vary within very wide limits, between  $n = 5.32$  (Sokolovsky- Ruppeneit, for pillars) and  $n=33$  (Protodiakonov, for span of rooms). Which means a very large stability reserve for both the rooms and the pillars and ceilings. Exceptions are the calculated values of the safety factors for checking the pillars according to the procedures of Stamatiu (1959, 1962) ( $n = 2.22$ ) and Şeviaikov ( $n = 1.66$ ). Considering the degree of simplification of these calculation hypotheses (Stamatiu's hypothesis is based on the analogy with the behavior in laboratory tests of prismatic samples with a square base; and that of Şeviaikov, on the uniform compressive stress of the pillars), these values can also be considered as covering.

Taking into account the values of the safety factors in table no.4, calculated according to all the analytical procedures, correlated with the data in table no.5, it can be estimated that the stability period of the rooms, pillars and ceilings exceeds 10 years (less after Stamatiu's procedure), which is the maximum period of operation of each level, at the current mining capacity of approx. 110 thousand tonnes per year.

**Table 5.** Stability duration of pillars and ceilings depending on the safety factor (Hirean & Georgescu, 2012)

PILLARS (after V.V.Sokolovsky&K.V.Ruppeneit)			CEILINGS	
Stability duration, in years	Safety factor, $n$	Loading rate, $\Delta$	Stability duration, in years	Safety factor, $n$
$\geq 20$	$\geq 3.33$	$\leq 0.3$	$\geq 70$	$\geq 3$
(20 - 10]	(3.33 – 2.5]	(0.3 – 0.4]	(70 - 20]	(3-2.78]
(10 – 2.7]	(2.5 - 2]	(0.4 – 0.5]	(20-10]	(2.78-2.68]
$< 2.7$	$< 2$	$> 0.5$	$< 10$	$< 2.68$



### 3. CALCULATION OF SAFETY FACTORS BASED ON THE RESULTS OBTAINED FROM NUMERICAL MODELS

In order to analyze the stability of the rooms and resistance structures at the Ocnele Mari Salt Mine, based on the safety factors, two 2D calculation models with finite elements were generated in a longitudinal section E-W, namely: a) with the horizons +226 m and +210 m fully exploited (2020 situation); b) with the horizons +226 m, +210 m and +190 m exploited (the situation predicted for the year 2030).

The dimensions of the model are:  $X = 2,200$  m (E-W) and  $Y = 343$  m (after vertical). The discretization of the 2D models, respectively of each region, was made by finite elements of triangular surface with square interpolation, respectively with a total number of 73,097 nodes and 32,624 elements of triangular surface (fig.1).

The characteristics of the rock salt were considered to be homogeneous and isotropic and were taken into account in the hypothesis of elasto-plastic behavior without hardening, Mohr-Coulomb type (see table no.3).

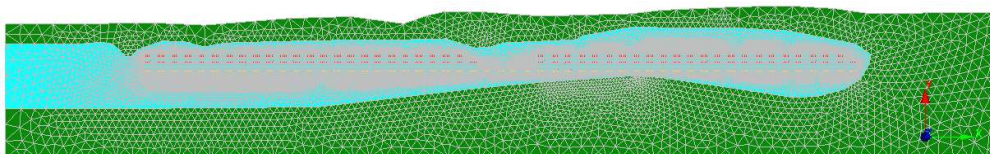

**Figure 1.** The model with 2D finite elements for the rock salt deposit from Ocnele Mari Salt Mine

A synthetic approach to the stability analysis of support structures based on numerical calculation models can be achieved only by applying some failure criteria. In the present case, the Mohr-Coulomb criterion was used, in which the principal stresses, together with the characteristic curve of rock salt (the resistance parameters of the rock salt mass are involved), play a significant role in assessing the behavior of support structures (rooms, pillars, ceilings).

We note that the CESAR-LCPC finite element calculation program does not provide the values of the safety factors necessary to assess the stability of the rocks on the contour of the mining excavations according to certain failure criteria. Therefore, such a criterion was introduced for models with 2D finite element, starting from the intrinsic curve of the rocks. For a certain point, characterized by a certain state of stress, the corresponding Mohr circle is determined and is related to the intrinsic curve of the rock salt. In this regard, the Mohr-Coulomb line (defined by the relation:  $\tau = C + \sigma \cdot \tan \varphi$ ) is taken into account and the following conditions are established (Lin Jifang, 1990):

- a) If  $\sigma_2 < R_t$ , for  $R_1 = (C \cdot \tan \varphi - S_c) \cdot \sin \varphi$ ,  $n = R_1 / R$  ; ;
- b) If  $\sigma_2 \geq R_t$ , then  $n=0$ .

where:  $S_c = \frac{\sigma_1 + \sigma_2}{2}$  represents the abscissa of the center of Mohr's circle;

$R = \frac{\sigma_1 - \sigma_2}{2}$  - radius of Mohr's circle;  $R_1$  - radius of the Mohr circle tangent to the Mohr-Coulomb line;  $n$  - safety factor;  $R_t$  - tensile strength of rock salt;  $C$  - rock cohesion;  $\varphi$  - the internal friction angle of the rock salt;  $\sigma_1, \sigma_2$  - the maximum (fig.2.a) and minimum (fig.2.b) principal stresses, respectively, calculated with the following relation:

$$\sigma_{1,2} = \frac{1}{2} \cdot (\sigma_{xx} + \sigma_{yy}) \pm \sqrt{\frac{1}{4} \cdot (\sigma_{xx} - \sigma_{yy})^2 + \sigma_{yx}^2}$$

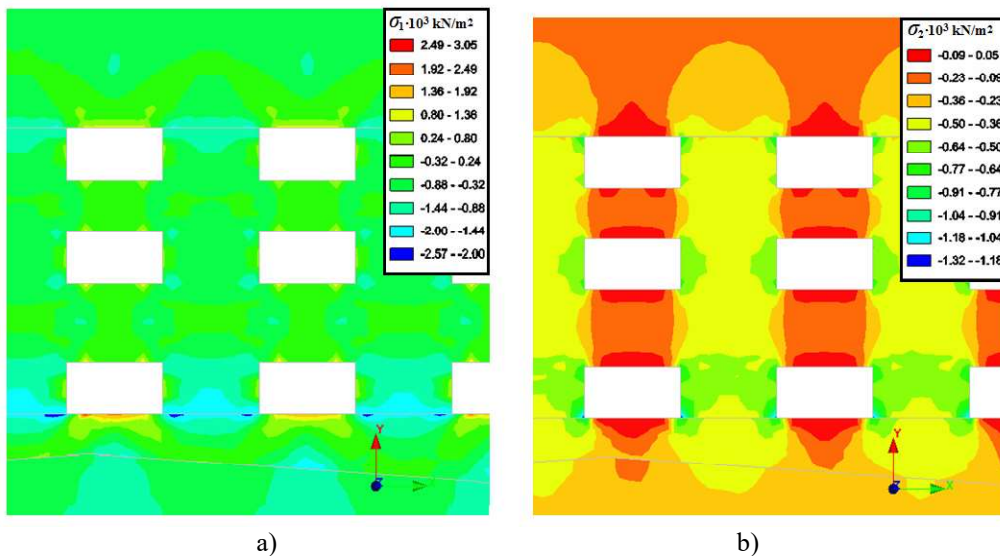

Figure 2. Maximum (a) and minimum (b) principal stresses, east side Ocnele Mari Salt Mine – scalar representation

Regarding the calculated value of the safety factor  $n = R_1/R$  there are three cases of stability:

- 1)  $n = 1$ , when Mohr's circle and intrinsic curve are tangent - resulting in boundary stability;
- 2)  $n < 1$ , when the Mohr circle and the intrinsic curve are secant - resulting in conditions for the occurrence of failure phenomena;
- 3)  $n > 1$ , when the stress state is far from the failure phenomenon - resulting in a certain degree of stability, depending on the value of the safety factor.

In the finite element models presented above, the safety factors were calculated according to some horizontal sections, from an area located in the center of each side (east and west), at the level of the ceiling (fig.3 and 6) and the floor (fig. 4 and 7) of 6 rooms from the horizon +226 m, +210 m and +190 m and at half the height of a central

pillar (fig.5 and 8). The calculations were performed based on the minimum and maximum principal stresses extracted from the 2D finite element models. Because the values of the safety factors for the two sides of deposit are relatively close, this paper presents the results obtained only for the east side, where the depth is greater.

Analyzing the variation of the safety factors in the ceiling between the horizon +226 m and +210 m and between the horizons +210 m and +190 m (both at the level of the floor of the rooms - fig.4 and 7, and at the level of the ceiling - fig.3 and 6), it is found that the ceilings are in a very good stability towards their center, the safety coefficient having very high values (up to the order of tens). The values suddenly decrease to  $n = 2-2.5$  near the walls of the rooms, there are very rarely local conditions of detachment of pieces of rock salt from the ceiling of the rooms, at a distance of up to 1 m from the walls and only in the presence of inhomogeneities or major cracks in the structure of the rock salt massif.

Regarding the variation of the safety factors at half the height of the pillars (fig.5 and 7), it can be mentioned that they have a relatively good stability towards their center, where the safety factors reach the value of  $n = 2.4 - 2.8$ , which progressively decreases to their outer surface, where the safety factors are approx.  $n = 1.4-1.5$ . This could explain the appearance of rock salt exfoliation after the outer surface of the pillars and the rounding of their corners (due to the concentration of stresses, especially traction and shear, in these areas).

If a comparative analysis is made between the model with 2 exploited levels (fig.5) and the model with 3 exploited levels (fig.8), it is found that, in the first case, the pillars from the horizon +226 m have a higher safety factor larger than those at the horizon +210 m, given the deeper geostatic stresses. Regarding the three horizons model, we find, at least in the area in the middle of the pillars, a higher stability of the pillars located at the horizon +190 m compared to those at the horizon +210 m. The argument would be the transfer of the loads from the two horizons, +226 m and +190 m, from the pillars connected with the rock salt massif to the roof and to the floor, to the pillars from the horizon +210 m, from the middle of the exploited area.

As can be seen from figures 5 and 8, the safety factor varies in the middle horizontal section of the pillars, delimiting 3 areas of behavior:

-*zone A*, extended on approx. 8-10 m, in the center of the pillar, in which the safety factor has values of  $n = 2.2 - 2.8$ , and the rock salt behavior is elastic towards elasto-plastic;

-*zone B*, on a width of approx. 2-3 m, around zone A, in which the safety factor decreases progressively from  $n = 2.0$  to the stability limit of 1.8 and the behavior is an elasto-plastic one;

-*zone C*, on a width of approx.1-2 m, outside the pillar, in which the safety factor is at the limit in the whole area ( $n < 1.4-1.6$ ), and the behavior of the rock salt can be appreciated as one elasto-visco-plastic.

If to the destructive effect of the massive stresses is added the effect generated by the detonation of explosives, then outside the zone C of the pillars can be added, on a depth of about 0.75-1m, a strongly cracked area, with a pronounced visco-plastic behaviour.

a) Graphical representation of the safety factors for the 2D model, after exploitation of levels +226 m and +210 m – East side (year 2020)

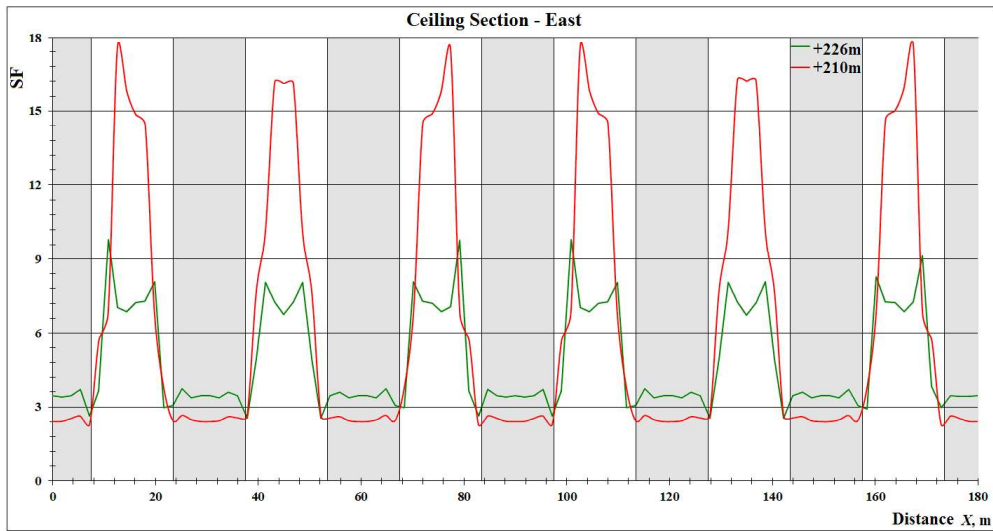

Figure 3. Safety factors, horizons + 226E, + 210E - Ceiling section, east side

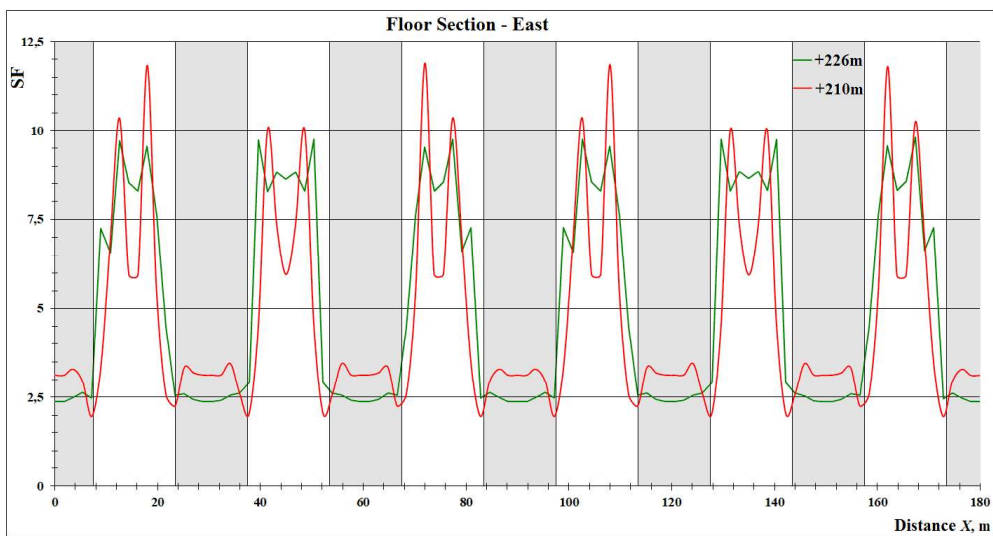

Figure 4. Safety factors, horizons + 226E, + 210E - Floor section, east side

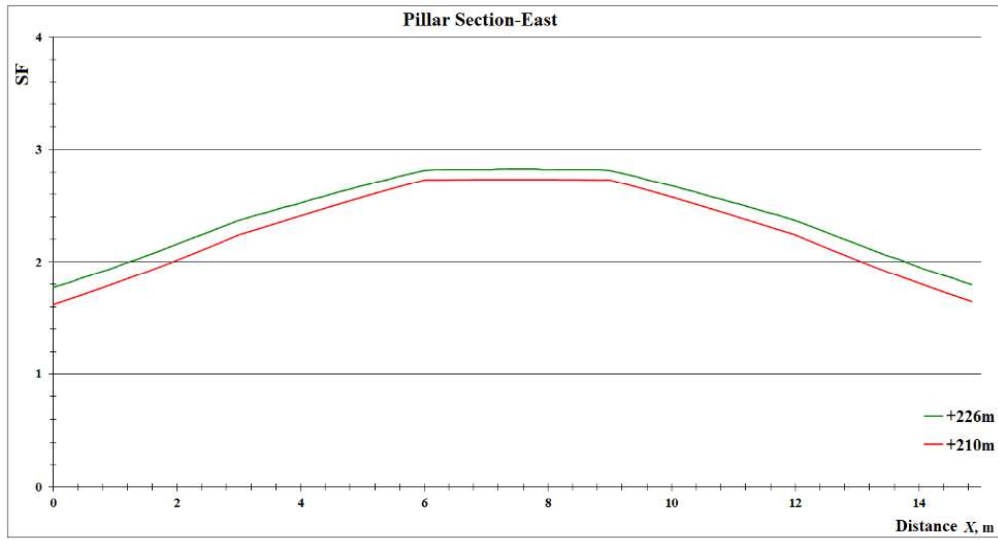

Figure 5. Safety factors, horizons + 226E, +210E - Pillar section, east side

b) Graphical representation of the safety factors for the 2D model, after exploitation of levels +226 m, +210 m and +190 m – East side (year 2030)

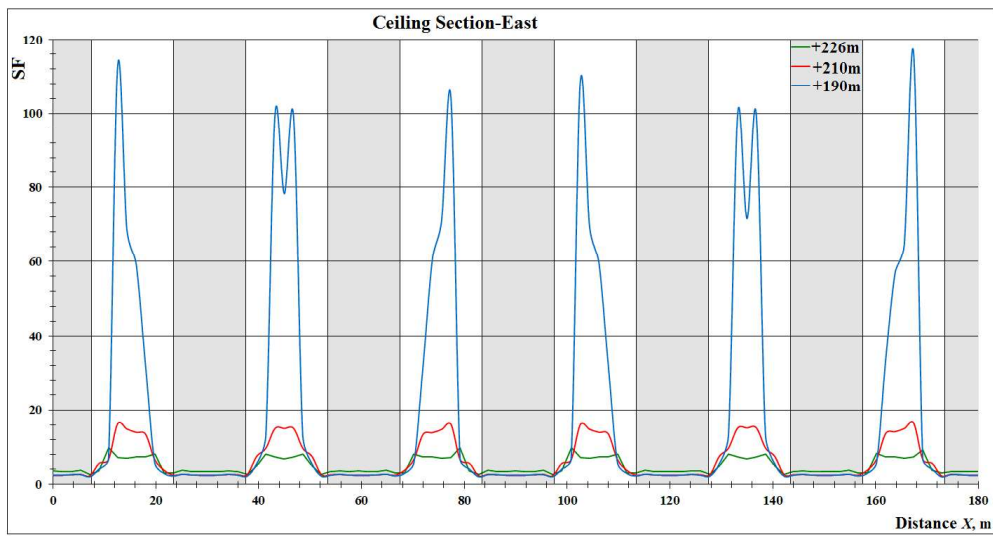

Figure 6. Safety factors, horizons + 226E, + 210E and +190E - Ceiling section, east side

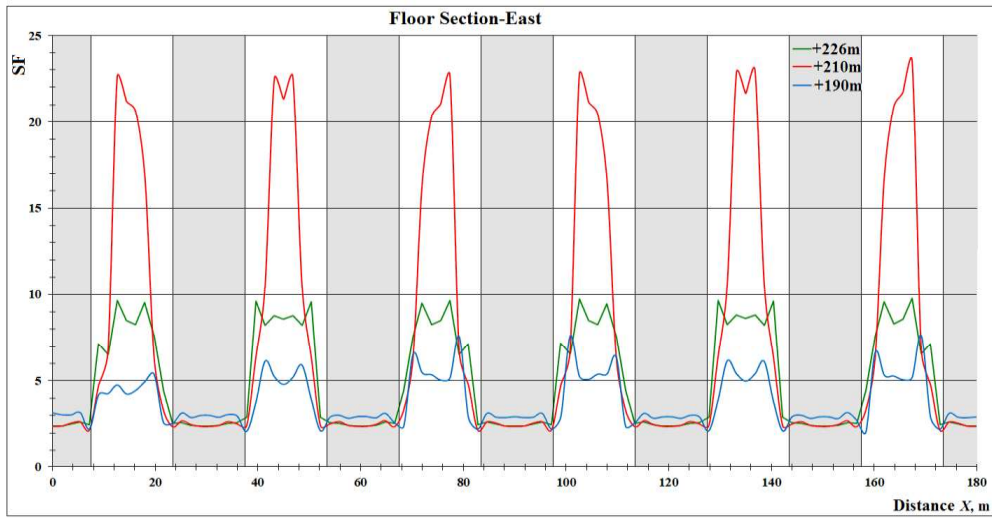

Figure 7. Safety factors, horizons + 226E, + 210E and +190E - Floor section, east side

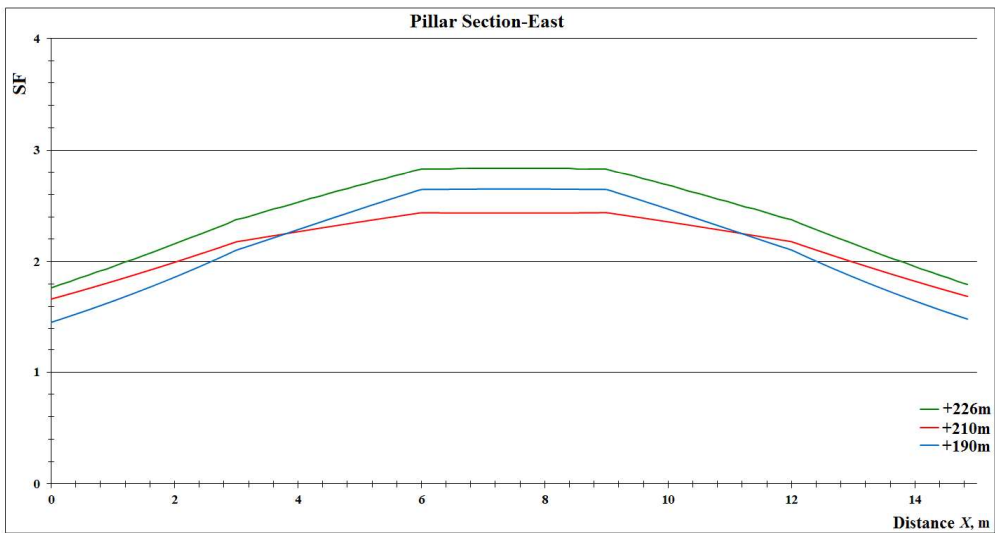

Figure 8. Safety factors, horizons + 226E, + 210E and +190E - Pillar section, east side

#### 4. CONCLUSIONS

Ocnele Mari Salt Mine started its activity of exploiting the rock salt in 1996, through the mining method with small rooms and square pillars, through the levels + 226 m and + 210 m. It is currently opening and mining the level +190 m.

The rooms and resistance structures (pillars and ceilings), designed using analytical calculation methods, were checked on the basis of safety factors determined by different analytical methods, supported by specific assumptions. The safety factors obtained from the calculations have values that vary in very wide limits, from  $n=5$  to

$n=33$ , which shows that the horizons studied have a good stability, at least during their period of mining.

Based on the models with 2D finite element, in elasto-plasticity, the safety factors were calculated, in the representative areas of the deposit, for the ceilings and floors of the rooms and the middle of the pillars, both for the case of the deposit exploited on three horizons (2020 situation), as well as for the case when the deposit will be exploited on three horizons (approx. in 2030).

The safety coefficients calculated from the numerical models have variable and relatively high values, in the representative sections of the models, which explains a good stability of the resistance structures in the analyzed cases. Compared to analytical methods, these coefficients highlight areas with relative stability, such as breaking the corners of the pillars, exfoliating their surface and areas of the ceiling, near the pillars, where local rock salt detachments may occur.

## 5. REFERENCES

- [1]. Covaci, Ș. et al. (1999), *Underground Mining, Vol.II* (in Romanian), Corvin Publishing House, Deva.
- [2]. Hirian, C. (1981), *Rock Mechanics* (in Romanian), Didactic and Pedagogical Publishing House, Bucharest.
- [3]. Hirian, C., Georgescu, M. (2012), *Stability of old salines in Romania - condition of their use for various fields* (in Romanian), Universitas Publishing House, Petroșani, 2nd Edition.
- [4]. Herget, G. (1988), *Stresses in rock*, Balkema.
- [5]. Jifang, Lin (1990), *Modélisation des milieux anisotropes. Application du logiciel CESAR-LCPC à l'étude des ardoisiers d'Angers*, DEA de Génie civil et minier, Laboratoire de Mécanique des Terrains, ENSM Nancy.
- [6]. Marica, D. (2011), *Study of the stability of mining excavations at the Ocele Mari salt mine in order to increase the degree of work safety* (in Romanian), PhD thesis, University of Petroșani.
- [7]. Onica, I., Marian, D.P. (2016), *Applications of the finite element method in the analysis of stability of grounds and underground structures* (in Romanian), Universitas Publishing House, Petroșani.
- [8]. Onica, I., Cozma, E., Marica, D. (2011), *Stability Analysis of the Rock Salt Rooms and Pillars of the Ocele Mari Saline with the Aid of the 2D Finite Element Modelling*, *Annals of the University of Petroșani, Mining Engineering, Vol.12 (XXXIX)*, pag.7-17.
- [9]. Popescu, Al., Todorescu, A. (1982), *Rock mechanics in mining* (in Romanian), Technical Publishing House, Bucharest.
- [10]. Stamatiu, M. (1962), *Rock mechanics* (in Romanian), Didactic and Pedagogical Publishing House, Bucharest.
- [11]. Stamatiu, M. (1959), *The problem of sizing of pillars at rock salt mines in Romania* (in Romanian), Academy Publishing House, 1959.





## NUMERICAL MODELING OF THE STABILITY OF THE RESISTANCE STRUCTURES FROM OCNELE MARI SALT MINE USING THE FINITE ELEMENT METHOD

Marian Dacian-Paul<sup>1</sup>, Onica Ilie<sup>2</sup>

**Abstract:** *The Ocnele Mari salt deposit has been exploited since 1996 with the mining method of with small rooms and square pillars. So far, the + 226m and + 210m horizons have been fully exploited, and the + 190m horizon is opening. This article presents the synthesis of the stability analysis of the resistance structures from Salina Ocnele Mari with the help of models with 3D finite elements, in elasto-plasticity, in the conditions of exploitation of the first two horizons and in perspective, following the exploitation of the third horizon. The stability analysis focused on the areas affected by the instability, confirmed by the in situ reality.*

**Keywords:** *rock salt, rooms and pillars mining, stability, displacement, stress, strain, numerical model, finite element*

### 1. INTRODUCTION

The rock salt deposit from Ocnele Mari is of medium Badenian age, has the shape of a lens, with dimensions of approx. 7.5 km (E-W), and 3.5 km (N-S) and variable thicknesses, with a maximum value of 450 m, in the central part of the lens (Hirean & Georgescu, 2012; Marica, 2011; Marian & Onica, 2016).

In 1996, the solid way exploitation of the Ocnele Mari - Cocenești deposit began, using the mining method with small rooms and square pillars (on a 30 x 30 m network), in a descending way (Covaci et al., 1999). By 2020, two levels were extracted, 16 m high, corresponding to the horizons +226 m and +210 m. In the west side, the dimensions of the rooms are 16 m wide and the pillars 14 x14 m, and in the east side, the rooms are 15m, and the pillars 15x15 m. The ceiling between the two horizons is 8 m thick. Starting with 2020, under a 12 m ceiling, it is opening level +190 m, which will be fully exploited with 15 m wide rooms and 15x15 m pillars (Marian & Onica, 2016).

The stability analysis of the rooms and resistance structures (pillars and ceilings), for the situation in 2020 (with the horizons +226 m and +210 m exploited), then the one in 2030 (with the horizon +190 m fully exploited), was carried out, among others, and by numerical modeling using the finite element method.

In general, numerical models used in rock mechanics are based on the fundamental principles of two methods, namely: differential methods and integral methods (Onica & Marian, 2016). In the case of differential methods, the real field

---

<sup>1</sup> *Assoc.Prof.PhD.Eng.* University of Petroșani, Romania, dacianmarian@upet.ro

<sup>2</sup> *Prof.Habil.PhD.Eng.* University of Petroșani, Romania, onicai2004@yahoo.com

studied (for example, a continuous rock mass) is replaced by a schematic representation with the same dimensions, subject to the same boundary conditions and consisting of a set of subdomains or finite size elements.

Basic equations, such as the (differential) equilibrium equation, the relationships that define the continuity of the environment (the deformations that derive from the field of motion), the law of behavior, etc. are solved by means of a numerical approximation on each element. The finite element method is a typical case of the differential method. Also, finite difference calculation methods belong to this group of methods (Onica & Marian, 2016).

The integral methods aim at determining the displacement field and the state of stresses in the environment, deducing them from the knowledge of the forces distributed on a surface belonging to the studied field. This surface can be an internal border, as in the boundary element method. The forces distributed on this boundary are adjusted in such a way that here are found, at each point, the known stress vectors, after the integration of the forces distributed along the whole boundary. Integration is done by discretizing the boundary into elements that contain nodal points (Onica & Marian, 2016).

In the case of these two methods, it is necessary to solve, at a certain stage, some linear systems of important dimensions, for finite elements or, for boundary elements, in which the modification of a coefficient has repercussions on the set of results.

These methods are sometimes called implicit, as opposed to explicit methods (for which the solution is done locally), for independent equations that represent an element and the immediately adjacent elements. The distinct element method is an example of an explicit method (Onica&Marian, 2016).

Fig.1 shows a general classification scheme of the numerical methods used in the analysis of rocks stability and mining excavations.

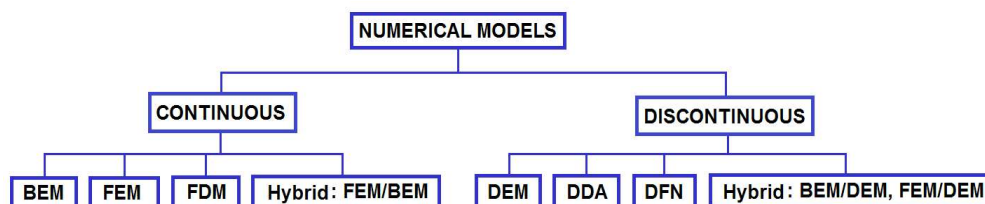

**Figure 1.** Classification of numerical models used in the analysis of rocks stability and mining excavations

FEM - finite element method, FDM - finite difference method; DEM - discrete elements method; DDM - displacement discontinuity method; BEM - boundary element method

Table no.1 contains the main computational programs and related 3D numerical methods, most frequently used worldwide in the analysis of the stability of lands, rocks, excavations and underground structures, in the case of rock salt deposits (Vattanasak (2006); Klayvimut (2003)).

**Table 1.** Computational programs for 3D numerical models of behavior analysis of mining excavations and underground structures, in the case of rock salt deposits (Vattanasak (2006); Klayvimut (2003))

Code	Numerical method*	References
BEFE	BEM 3D	Beddoes (1994)
VELMINA	DDM 3D	Frayne (1998)
VNFOLD	DDM 3D	Beddoes (1994)
FLAC	FDM 3D	Itasca (1994); Frayne (1996, 1998)
SUVIC-D	FEM 3D	Julien et al. (1998)
VISAGE	FEM 3D	Ong (1994)
*FEM - finite element method; FDM - finite difference method; DDM - displacement discontinuity method; BEM- boundary element method		

CESAR-LCPC finite element software, with CLEO3D processor, is used in this paper to analyze the stability of excavations and underground mining structures at the Ocnele Mari salt mine.

CESAR-LCPC is a general computational program, based mainly on the finite element method, with its own pre and post-processing functionalities. This program is specially adapted to solve civil / mining and environmental engineering problems, such as: structural calculation, soil and rock mechanics, thermal, hydrogeology, etc. (Humbert et.al., 2005).

## 2. DESCRIPTION OF THE 3D FINITE ELEMENT MODELS

The CESAR-LCPC 3D code was used in this paper for the realization of computational models with 3D finite elements, in the hypothesis of elastic-plastic behavior.

For the models with 3D finite elements were analyzed both the current situation of the Ocnele Mari Salt Mine (with horizons +226 m and +210 m, fully exploited) - year 2020, and the perspective (to which will be added the full exploitation of the horizon +190 m) - in 2030. Due to the significant expansion of the deposit, especially along the E-W direction, it was not possible to make a single numerical model to represent the entire salt mine. Therefore, two models were made, one for the east side and another for the west side, finally resulting in four computational models, whose dimensions X, Y and Z and their discretization presented in table no.2.

**Table 2.** The dimensions of the finite element models from Ocnele Mari Saline

Finite element models	Dimension, m			Model meshing	
	X	Y	Z	Total number of nodes	Total number of volume elements
Model 3D – eastern side	1,190	1,255	350	82,888	76,014
Model 3D – western side	1,235	1,255	350		

In order to make 3D models, the geometry of the excavations, the natural boundaries of the rock salt deposit and the geometry of the ground surface were generated, in accordance with the 3D transposition of the situation plans from the Ocnele Mari Salt Mine. Both the deposit and the surrounding rocks were considered continuous, homogeneous and isotropic, and the loading of the models was geostatic.

Carrying out the analysis with finite elements in 3D, for the models defined above, required the following steps: a) establishing the limits, the area of interest and discretizing the model; b) determination of zones (regions), calculation hypotheses and introduction of geomechanical characteristics; c) imposing boundary conditions; d) establishing the initial and loading conditions of the model; e) performing calculations and storing results (Onica & Marian, 2016).

In order to simplify the 3D numerical models, two regions with specific geomechanical characteristics were considered, corresponding to the surrounding rocks and the rock salt deposit, in the hypothesis of the elasto-plastic type behavior without hardening, of the Mohr-Coulomb type.

Thus, the mass of rock salt ( $S$ ) is characterized by the following properties: apparent specific gravity,  $\gamma_a^S = 21.5 \text{ kN/m}^3$ ; modulus of elasticity,  $E^S = 1.5 \cdot 10^6 \text{ kN/m}^2$ ; Poisson's ratio,  $\nu^S = 0.25$ ; compressive strength,  $\sigma_c^S = 21,700 \text{ kN/m}^2$ ; tensile strength,  $\sigma_t^S = 1,200 \text{ kN/m}^2$ ; shear strength,  $\tau_s^S = 2,300 \text{ kN/m}^2$ ; cohesion,  $C^S = 4,000 \text{ kN/m}^2$ ; internal friction angle,  $\varphi^S = 30^\circ$ . And the surrounding rocks ( $R$ ) are characterized by the following properties:  $\gamma_a^R = 19 \text{ kN/m}^3$ ;  $E^R = 7 \cdot 10^5 \text{ kN/m}^2$ ;  $\nu^R = 0.22$ ;  $C^R = 1,000 \text{ kN/m}^2$ ;  $\varphi^R = 18^\circ$  (Onica et al., 2011; Marian & Onica, 2021).

Regarding the boundary conditions of the 3D models, for the displacements  $u$ ,  $v$  and  $w$ , along the  $x$ ,  $y$  and  $z$  axes, the ground surface was considered free, and the lateral and lower surfaces were blocked (for the lower surface  $w = 0$  and the horizontal ones  $u = v \neq 0$ , and for the sides,  $w \neq 0$ , and  $u = v = 0$ ).

The initial loading conditions of the 3D models were geostatic, corresponding to variable thicknesses of the cover formations (Herget, 1988).

The results of the calculations were stored in graphical form (scalar, vectorial and tensorial) on the surfaces and volume of the models and in predefined sections.

### 3. ANALYSIS OF THE RESULTS OBTAINED FROM NUMERICAL MODELING

In order to solve the presented problems, the stress concentration reports according to the coordinate directions and the principal maximum / minimum stresses can describe the stress imbalance and implicitly the possibility of occurrence of failure phenomena. A higher ratio between these stresses makes the circle of the principal stresses intersect the characteristic curve of the rocks, which means the development of phenomena of failure or opening of cracks or fissures in the massif. Also, from the point of view of stability, the study of tensile and shear stresses is very significant, knowing that the rock salt has very

low tensile and shear strengths and most often the failure occurs due to exceeding these limits. The analysis of the values of vertical and horizontal displacements and the orientation of the corresponding vectors can suggest the amplitude and the sense of development of the deformation phenomena (Onica & Marian, 2016).

Due to the complexity of the 3D models, in order to make the stability analysis more explicit, the exploited horizons (+226 m and +210 m) and the horizon that will be exploited in the future (+190 m) were represented in fig. 2, for the eastern side of the Ocnele Mari Salt Mine and in fig. 3, for the western side of the salt mine. In these figures were marked the plasticization areas of the pillars and ceilings, determined from the model with the three horizons exploited, the stability analysis focusing on these areas, considered to be the most affected in terms of stability.

From Fig.2.a it can be seen that at the level of +226 m - the east side, the area most affected in terms of stability of the resistance structures is the one from the south, at the level of the rooms and pillars arranged at the intersection between the group of alignments 44-49 and E-B. To the north, the H47 pillar and the floor of the I47 room are particularly affected, probably due to the configuration of the excavation, relative to the spatial position of the rooms on the lower horizon.

At horizon +226E, the most affected are the resistance structures in the area of rooms C47 and C48, then those in the area of rooms E47 and C47, followed by E45, D45, D46 and C45.

It should be noted that these areas affected by plasticization are in accordance with the ground surface landmarks with the highest subsidences and subsidence speeds, located at the eastern end of the mining field where maximum subsidences have reached the value of 140-177 mm, and subsidence speeds of 1.2-1.8 mm /month.

At the + 210E horizon, the area of the G30 ÷ G33 rooms is affected by plasticization. Due to some phenomena of stability reduction, there was a need to consolidate the directional room in the G31 ÷ G33 area (Kovacs, 2012). This situation in the field somewhat validates the results obtained from numerical modeling with finite elements, bringing a certain credibility to other areas of the models marked by plasticization (Marian & Onica, 2021).

Regarding the horizon +190 m, which will be put into mining in the immediate future, there are two areas affected by a minor instability, located at the intersection between the transverse alignments 38 ÷ 40 with the directional alignments H-G and between the alignment 43 with the H-G alignments.

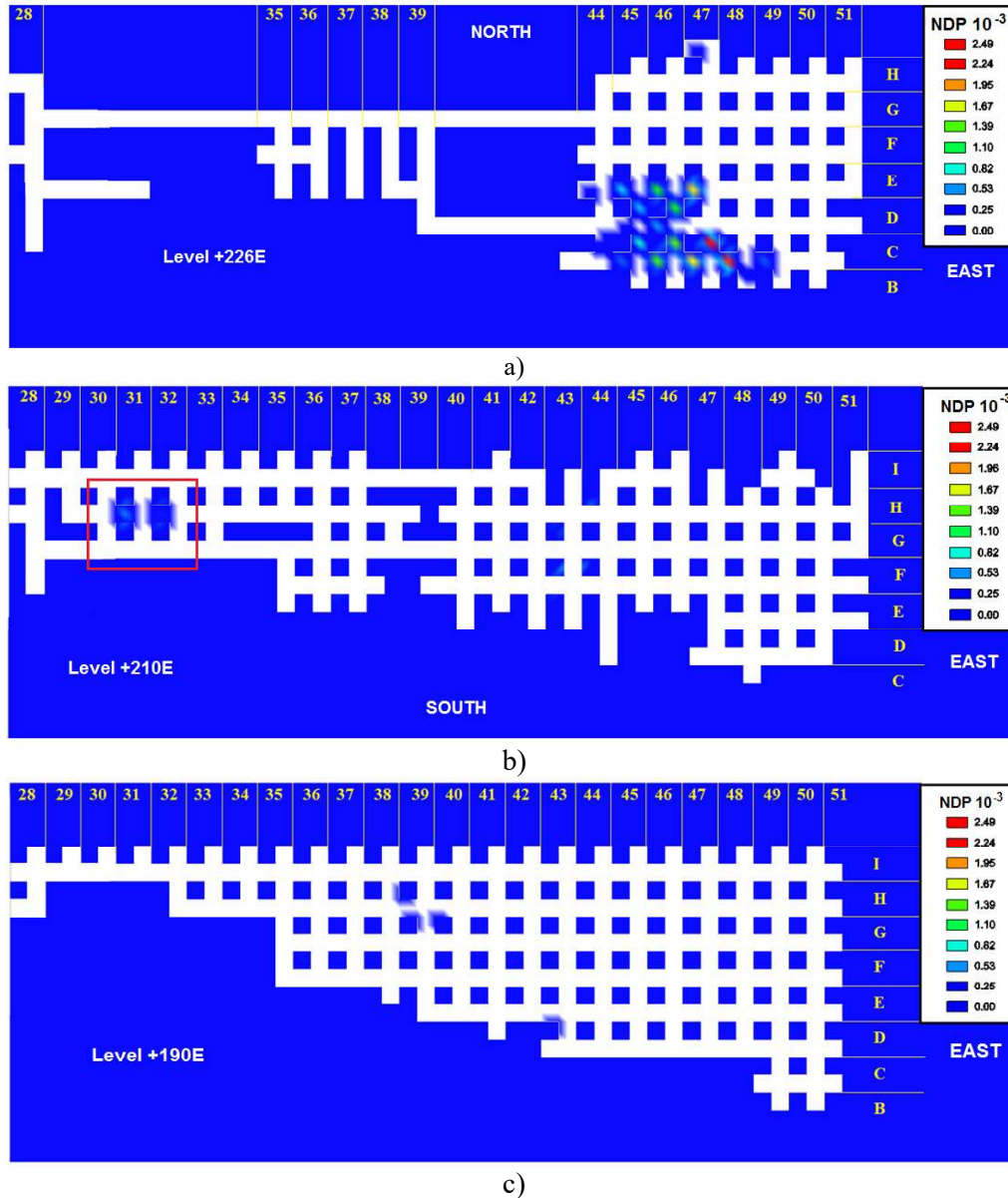

**Figure 2.** Situation plan of the horizons in the eastern side of the Ocnele Mari Salt Mine: a) +226 m; b) + 210m; c) +190 m (with the distribution areas of the NDP plastic deformation norm)

As can be seen from Fig. 3, the resistance structures in the western side are less marked by instability, from the point of view of the state of stress and strain, certain instability phenomena appeared in this part of the Ocnele Mari Salt Mine, the consequence of the inhomogeneities and natural fissures existing in the rock salt massif. Thus, at the level +226 W (fig.3.a) it is possible to observe the entry into plasticization of the resistance structures only in the area of rooms F24 and F25. At the

level +210 W (fig.3.b) the stability of the resistance structures near the rooms G25 and G26 is affected. If the configuration of horizon +190 W is kept as in the project, at the end of the mining it is foreseen that there will be no massive regions affected by instability.

The study of the stability of the ceiling between the horizons +226 W and +210 W in the work (Pușcaș et al., 2014) with reference to the fissures appeared in the area of rooms 24-25 (table no.3), validates once again the results obtained from finite element modeling of the Ocele Mari Salt Mine.

**Table 3.** The situation of fissures in the ceiling between the horizon + 226 m and +210 m, in the area of rooms 24-25

Fissure	Room	Between pillars	Fissure length, m	Fissure	Room	Between pillars	Fissure length, m
<i>F1</i>	H	G25-H25	8,80	<i>F4</i>	H	H24-G24	11,43
<i>F2</i>	24	H24-H25	6,42	<i>F5</i>	H	H23-G23	8,45
<i>F3</i>	24	H24-H25	8,86	<i>F6</i>	G	G23-F23	9,90

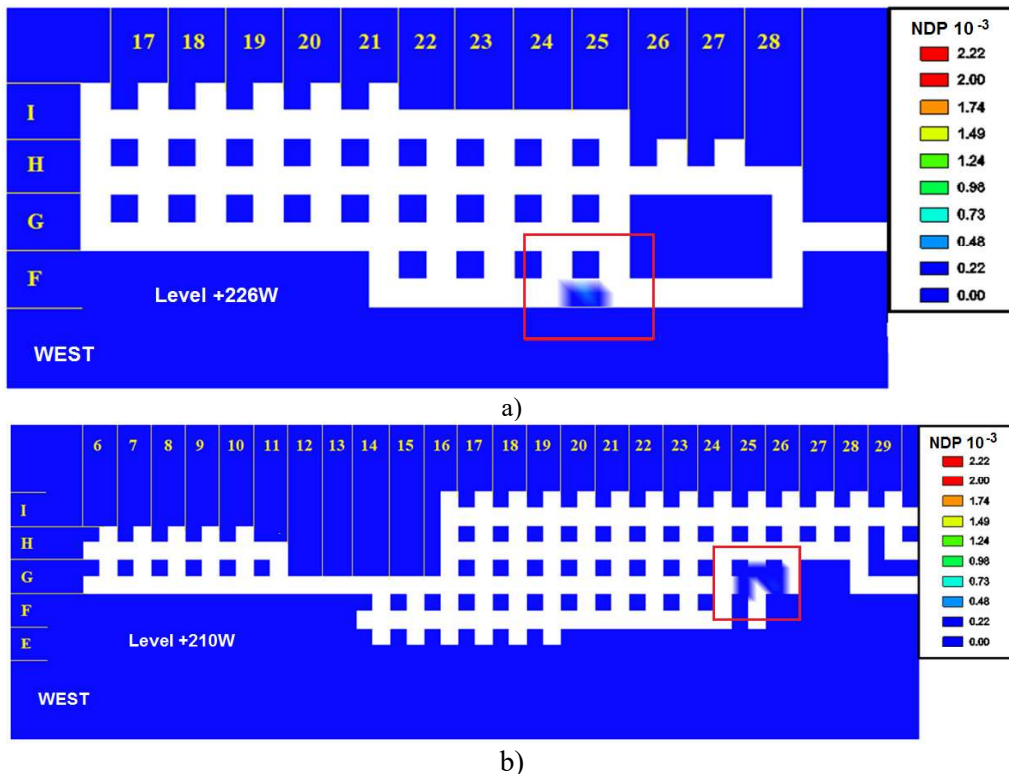

**Figure 3.** Situation plan of the horizons in the western side of the Ocele Mari Salt Mine: a) +226m; b) +210m; (with the distribution areas of the NDP plastic deformation norm)

The *vertical displacements*  $w$  at horizon +226 E are concentrated on the ceiling of the directional room C and on the rooms D45-46 and E45-46, in the form of swellings of the floor. The G29 ÷ 34, E29 ÷ 31, D40 ÷ 44 directional rooms and the 51 transverse room are also subject to floor swelling phenomena. There is a subsidence of the ceiling in all other rooms on this horizon, especially in the western part of rooms G and F.

Regarding the +210 E horizon, the vertical movements are marked by swellings of the floors in all the rooms located on this horizon. With the exploitation of the +190 E horizon, the swellings become subsidence of the ceiling built between the two horizons, less the floor of the H29 ÷ 33 rooms and the 50-51 transversal rooms, where the floor swelling phenomena will continue to manifest.

In the western side of the salt mine, the vertical displacements  $w$ , at the +226 W level are concentrated on the east floor of the F26 ÷ 28 directional room, with a development of the maximum value in the F28 room.

At the +210 W level all rooms suffer from floor swellings, except for the first third of the transverse rooms from the mining edges, from the north and south, which are affected by subsidences.

And in this case, after extracting the reserves from the +190 W level, the swellings of the +210 W horizon become subsidences in the ceiling between the two horizons, except for the rooms at the western end (6 ÷ 11)/(H-G) and the rooms from the center of the G24-25 and G28-29 of mining field. Floor from all rooms of horizon +190 W manifests swelling phenomena of varying degrees.

The *horizontal displacements*  $u$  are oriented in the E-W direction, and the *horizontal displacements*  $v$  in the N-S direction.

The horizontal displacements  $u$  are greater towards the eastern (positive) and western (negative) limit of the model, increasing in value with the increase in depth of the mining excavations. Both on the horizon + 266 E and on the horizon + 210 E the eastern surface of the rows of pillars 50 and 51 have the tendency of maximum expansion in the W-E direction, and the western surface of the rows 44 and 45, in the E-W direction. At the horizon of +190 m, the same trends are maintained.

The horizontal displacements  $v$  are positive towards the north, and to the south they have negative values and are amplified with the passage from horizon +266 E to horizon +210 E and then to +190 E. Thus, at horizon +226 E, the northern surface of the H and G pillars tend to swell in the S-N direction, and the southern surface of the C and D pillars in the N-S direction.

In the case of horizons +210 E and +190 E, there is an expansion / swelling of the I and H pillars in the S-N direction and of the E and D pillars in the N-S direction.

In the western side, at horizon +266 W, the eastern surface of the rows of pillars 24 and 25 have the tendency of maximum expansion in the W-E direction, and the western surface of the rows 16 and 17, in the E-W direction.

In the case of +210 W horizon, the pillar rows 23 ÷ 26 undergo an expansion to the east and the rows 16 ÷ 19 to the west. At the horizon of +190 m, the same expansion trends are maintained, for the rows of pillars 21 ÷ 24, towards the east, and for the pillars 16 ÷ 19, towards the west.



In the case of horizontal displacements  $v$ , at all these horizons in the western side of mining field, the rows of I-H pillars have the tendency of maximum expansion/swelling towards the north, and the rows of pillars G-F, towards the south.

The *principal maximum (major)* (fig.4.a and 5.a) and *principal minimum (minor)* (fig.4.b and 5.b) stresses are the most representative for a stability analysis, their ratio highlighting the degree of equilibrium of the material points in the composition of the analyzed massif. According to the directions of the principal stresses, there are only tensile and compressive stresses, the shear stresses being equal to zero.

The *principal maximum stresses*  $\sigma_1$  (fig.4.a and 5.a) developed in the resistance structures are, in general, compression stresses, developed in the intercameral and marginal pillars, and tensile stresses, in the floors and in the walls of the chambers.

The tensile stresses reach the equilibrium limit in the middle of the ceiling, in the east side, especially in the directional room G (28 ÷ 34) and in the rooms E45-46, from horizon +226 m, and those of compressive, in the pillars (D-E)/(45 ÷ 47), and in the western side, especially in the directional room F(24 ÷ 28), from horizon +226 W (fig.5.a), and the compression ones, in the pillars (G-H)/(20-21), from the same horizon.

In the eastern side, at horizon +210 E (fig.4.a), the most requested compression pillars are those on the directional row H(30 ÷ 36) and in the area (I-F)/(41 ÷ 44), and in the western side +210 W, are the pillars on the directional rows G(6 ÷ 11) and F(15 ÷ 20).

In the corners of the pillars, the compressive stresses exceed -8,000 ÷ -10,000 kN/m<sup>2</sup>, in the east side, and in the west side they exceed -6,000 ÷ -8,000 kN/m<sup>2</sup>, which explains the phenomenon of rounding the corners of the pillars, which is accentuated towards their base.

All the *principal minimum stresses*  $\sigma_3$  (fig.4.b and 5.b), from the analyzed models, are compressive stresses with values over -3,000 kN/m<sup>2</sup>, which on average, in the center of the pillars reach approx. -10,000 kN/m<sup>2</sup> and exceeding the compressive strength towards the edges of the pillars, causing the phenomenon of exfoliation of the pillars on the contour. In the ceiling and in the floor of horizon +210E, the minor compressive stresses, on average, are approx. -3,400 kN/m<sup>2</sup>, reaching -8,000 ÷ -10,000 kN/m<sup>2</sup>, near the pillars. We note here, as the most requested by the minor principal stresses, the pillars D46-47, from the horizon +266 E and the pillars F42-43 and H31-32, from the horizon +210 E (fig.4.b), and in the western side, the most requested by the minor principal stresses, are the pillars G (20 ÷ 23), from the horizon +266 W and the pillars F(15 ÷ 20) and G(25 ÷ 26), from the horizon +210 W.

*Tensile stresses*  $\sigma_t$  primarily affect the ceiling, in the floor of horizon +226 m and in two areas of the ceiling of level +210 m, where the tensile strength limit (of +1,200kN/m<sup>2</sup>) and the third in the middle of the walls, where the stresses reach at half the value of the tensile strength of the rock salt. Areas marked in the ceiling of the rooms are prone to rock salt detachment and the formation of two collapse vaults, and cracks may appear in the floor of the rooms or pre-existing families of fissures may

open. In the walls of the rooms, especially at the corners of the pillars, in the middle area of them, failures can occur which, over time, reduce the load-bearing capacity of the pillars. In the east side, the following rooms are highlighted, in the floor of which the tensile strength of the rock salt can be exceeded, namely: directional room G(29 ÷ 34), transverse rooms (F-E)/(38-39), rooms (E-D)/(45-46), E44, E47 and I47, from horizon. +226 E; rooms H(40 ÷ 44), from horizon +210 E. In the western side, the following are the directional rooms H(18 ÷ 25) and F(24-25), from horizon +226 W; rooms E(17 ÷ 19) and G(21 ÷ 25), from horizon +210 W.

*Compression stresses*  $\sigma_c$  mainly influence the intercameral pillars, increasing from average values of about -10,000 ÷ -15,000 kN/m<sup>2</sup>, reaching the limit of compressive failure of rock salt (-21,700 kN/m<sup>2</sup>) on the outer surface of the pillars and in their corners, in particular in the areas of the horizon ceiling limit and the floor of horizon +210 E, which explains the phenomenon of rounding the corners of the pillars, which is accentuated towards their base. There is a presence of compressive stress relief areas in the ceiling and floor of the rooms, implicitly in the ceiling between the two horizons.

In the east side, the most important compressive stresses are developed in the pillars (D-E)/(45 ÷ 47), from the horizon +226 E, and on the horizon +210 E, the most requested compression pillars are those on the directional row H(30 ÷ 36) and from zone (I-F)/(41 ÷ 44). In the western side, the highest values are in the pillars (G-H)/(20 ÷ 21), from the horizon +226 W, and at the horizon +210 m, the directional rows G (6 ÷ 11) and F (15 ÷ 20).

The *maximum shear stresses*  $\tau_{\max}$  (fig.6) indicate the structural areas where there is the potential for the occurrence of shear failures of the rock salt or the mobilization of natural fissures or fractures existing in the massif. Because the value of the shear strength of the rock salt is quite low, approx. 2,300 kN/m<sup>2</sup>, shear stresses  $\tau_{\max}$ , together with tensile stresses  $\sigma_t$ , can be the cause of most phenomena of degradation of resistance structures (pillars, ceilings) and the occurrence of underground collapses.

The highest values of the shear stresses are at the limits between the upper part of the pillar and the ceiling of horizon +226 m, the floor of horizon +210 m and the base of the pillars, which reach values of over 4,500 kN/m<sup>2</sup> (fig.6). For the horizon +210 m, the shear stresses progressively extend from the ceiling of the pillars to below the level of the floor, at a depth of approx. 1.5-2 m. These shear stresses could cause the rock salt mass to failure, which would lead to the degradation of the future ceiling, between horizon +210 m and +190 m. One can notice a relaxation of the shear stresses from the ceiling of the rooms of horizon +226 m and from the floor of the rooms of horizon +210 m.

In the east side, the pillars with the most required outer surface when shearing are: (E-D)/(46-47), from horizon +226 E; pillars H(29 ÷ 37), G37 and F37, from horizon. +210 E. Similarly, in the west side, the pillars are affected: (H-G)/(18 ÷ 24), from horizon + 226 W; H(29 ÷ 37), H(25 ÷ 28), G (25-26) and F(17 ÷ 21), from horizon +210 W.

Following the analysis of the state of stress and strain developed in the rooms and resistance structures (pillars and ceilings) at Ocnele Mari Saline, resulting from numerical models with 3D finite elements, it can be concluded that the overall stability of rooms, pillars and ceilings is relatively good, and acceptable at the two horizons +226 m and +210 m, which makes these horizons can be functional for a limited time. It can also be predicted that the stability of the horizon +190 m will be good, both during the period of exploitation of rock salt reserves and after a certain period of time.

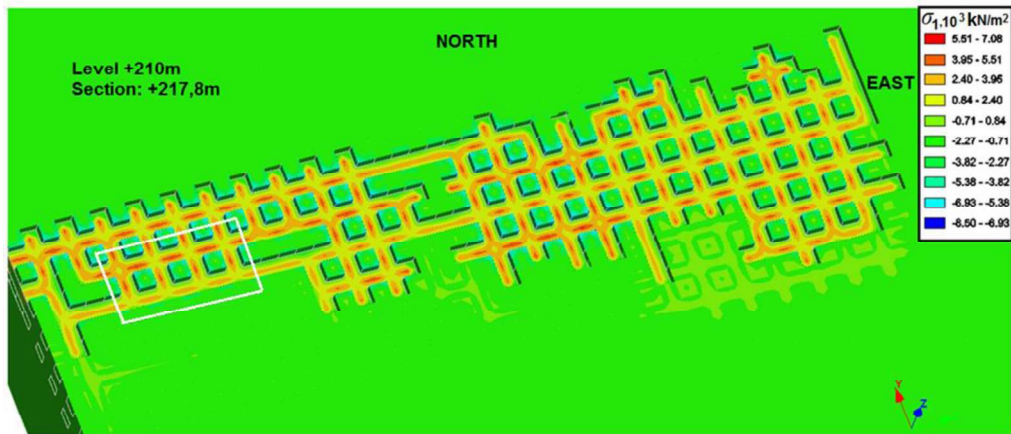

a)

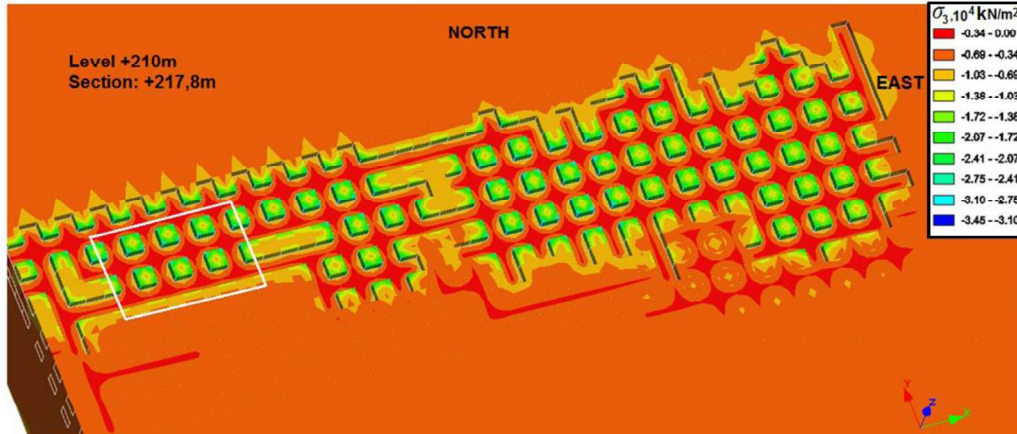

b)

**Figure 4.** Horizontal view + 210m - eastern side, with scalar representation of the (a) maximum  $\sigma_1$ , in  $\text{kN}/\text{m}^2$  and (b) minimum principal stresses  $\sigma_3$ , in  $\text{kN}/\text{m}^2$

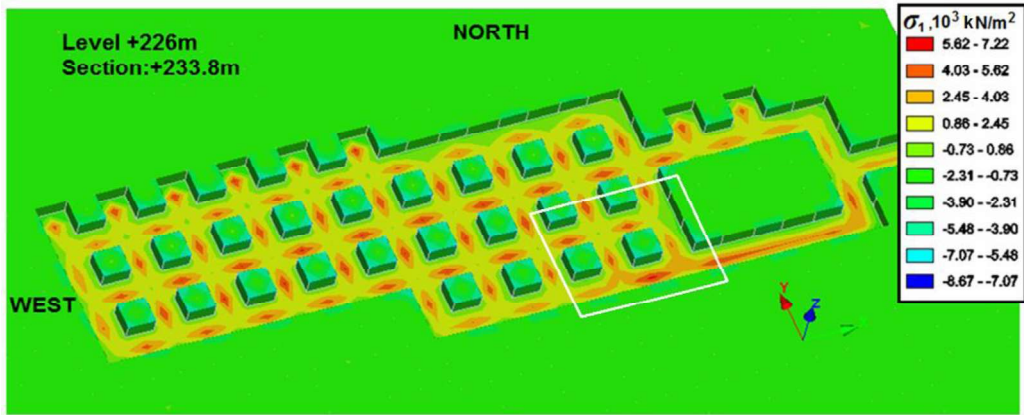

a)

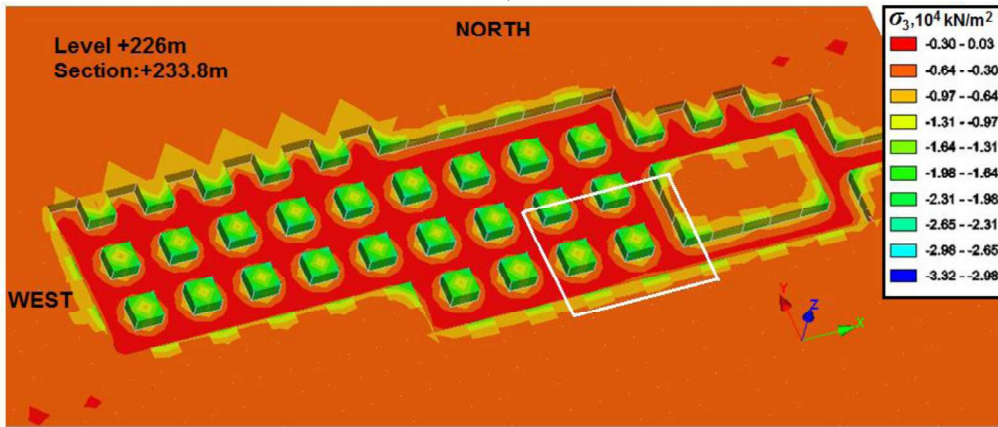

b)

**Figure 5.** Horizontal view + 210m - western side, with scalar representation of the (a) maximum  $\sigma_1$ , in  $\text{kN/m}^2$  and (b) minimum principal stresses  $\sigma_3$ , in  $\text{kN/m}^2$

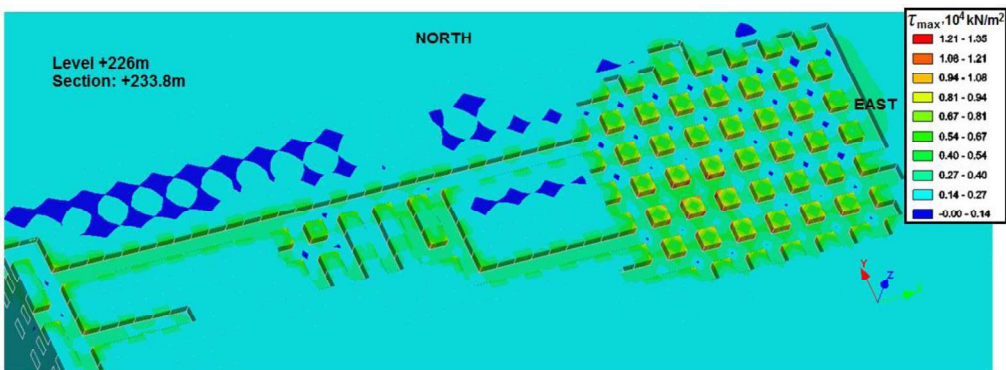

a)

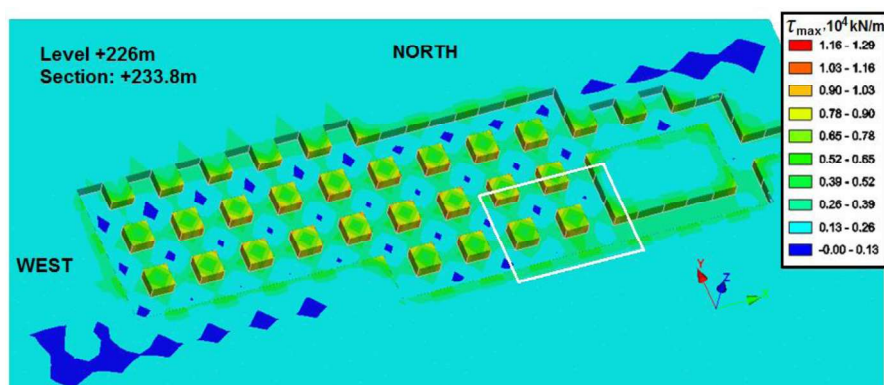

b)

**Figure 6.** Horizontal view of maximum shear stresses, in  $\text{kN/m}^2$   
a) Level +226 m-east; b) Level +226 m-west

#### 4. CONCLUSIONS

The rock salt deposit from Ocnele Mari has been exploited, since 1996, with the mining method with small rooms and square pillars. By 2020, the +226 m and +210 m horizons have been fully exploited, and now the +190 m horizon is opening.

The stability analysis of the rooms and resistance structures (pillars and ceilings) was performed using 3D finite element modeling, in elasto-plasticity. For this purpose, four finite element models were generated, two for each side of the deposit (eastern and western), with the horizons +226 m and +210 m fully exploited and then, after the exploitation of the horizon +190 m.

In general, the stability of the resistance structures is good, so the stability analysis focused on certain areas marked by the phenomenon of plasticization (entry into a state of instability) of the rock salt, also confirmed by the in situ reality.

The most affected areas are located in the eastern extremity of the mining field, where the highest subsidences and subsidence speeds of the land surface. Thus, at the horizon +210 E the area of the G30 ÷ G33 rooms is affected by plasticization. Due to some phenomena of stability reduction, it was necessary to consolidate the directional room with anchors and shotcrete in the area G31 ÷ G33.

The resistance structures in the west side are less marked by instability, in terms of the state of stresses and strains highlighted by the results of numerical modeling. Certain phenomena of instability that appeared in this part of the Ocnele Mari Salt Mine are supposed to be the consequence of the inhomogeneities and natural fissures existing in the rock salt massif. Thus, at the level +226 V, the entry into plasticization of the resistance structures can be observed only in the area of rooms F24 and F25. At the level +210 V, the stability of the resistance structures in the vicinity of rooms G25 and G26 is affected.

Although the stability of the Ocnele Mari salt mine is good, these local instability situations, highlighted on numerical models and confirmed in situ, somewhat validate the results obtained from numerical modeling with finite elements, bringing some credibility to other areas of marked plasticization models.

## 5. REFERENCES

- [1]. Beddoes, R.J. (1994), Analyses of bench test area at Goderich mine. Internal Report for Sifto Canada Inc., Prepared by Golder Associate Ltd., Calgary, AB, Canada.
- [2]. Covaci, Ș. et al. (1999), Underground Mining, Vol.II (in Romanian), Corvin Publishing House, Deva.
- [3]. Frayne, M.A. (1996), Four cases study in salt rock: Determination of material parameters for numerical modeling. In Proceedings of the Third Conference on the Mechanical Behavior of Salt (pp. 471-482). Clausthal-Zellerfeld, Germany: Trans Tech Publications
- [4]. Frayne, M.A. (1998), The Goderich salt mine: past, present & future. In Proceedings of the Fourth Conference on the Mechanical Behavior of Salt (pp. 445-458). Clausthal-Zellerfeld, Germany: Trans Tech Publications.
- [5]. Herget, G. (1988), Stresses in rock, Balkema.
- [6]. Hirian, C., Georgescu, M. (2012), Stability of old salines in Romania - condition of their use for various fields (in Romanian), Universitas Publishing House, Petroșani, 2nd Edition.
- [7]. Humbert, P., Dubouchet, A., Fezas, G., Remaud, D. (2005), CESAR-LCPC, un progiciel de calcul dédié au génie civil, Bulletin des Laboratoires des Ponts et Chaussées, 81 janvier-fevrier, pp.7-37.
- [8]. Julien, M.R., Foerch, R., Aubertin, M., and Cailletaud, G. (1998), Some aspects of numerical implementation of SUVIC-D. In Proceedings of the Fourth Conference on the Mechanical Behavior of Salt (pp. 389-402). Clausthal- Zellerfeld, Germany: Trans Tech Publications.
- [9]. Klayvimut, K. (2003), Mechanical performance of underground excavation in rock salt formation for nuclear waste repository in northeastern Thailand, Master of Engineering in Geotechnology, Suranaree University of Technology, 2003.
- [10]. Kovacs, F. (2012), Minimal flow of grinding rock salt in the underground of the Ocele Mari Salt Mine, Râmnicu Vâlcea Mining Branch. Volume II - Consolidation of the area of the grinding flow. Technical project phase and specifications, Symbol 3/4/2012, S.C.DACITROM SRL Cluj-Napoca
- [11]. Marian, D.P., Onica, I., (2021), Improving the stability of the directional room G31-33, horizon 210 - East, Ocele mari-Cocenești Salt Mine, by reinforcement with anchors and shotcrete, Mining Revue, No.4.
- [12]. Marica, D. (2011), Study of the stability of mining excavations at the Ocele Mari salt mine in order to increase the degree of work safety (in Romanian), PhD thesis, University of Petroșani.
- [13]. Ong, V. (1994), Evaluation of 3D VISAGE finite element program. Report submitted to SPPA.
- [14]. Onica, I., Marian, D.P. (2016), Applications of the finite element method in the analysis of stability of grounds and underground structures (in Romanian), Universitas Publishing House, Petroșani.
- [15]. Onica, I., Cozma, E., Marica, D. (2011), Stability Analysis of the Rock Salt Rooms and Pillars of the Ocele Mari Saline with the Aid of the 2D Finite Element Modelling, Annals of the University of Petroșani, Mining Engineering, Vol.12 (XXXIX), pag.7-17.
- [16]. Pușcaș, G. ș.a. (2014), Ceiling support for rooms 24-25, horizon + 210W, at Ocele Mari Salt Mine (in Romanian), Stage I-Study, Contract 693 / 21.01.2014, Symbol 34-876, SC MINESA - ICPM SA Cluj-Napoca.
- [17]. Vattanasak, H. (2006), Salt reserve estimation for solution mining in the Khorat basin, Degree of Master of Engineering in Geotechnology, Suranaree University of Technology.

## **SOLUTIONS FOR ISOLATING ZONE WITH DANGER OF FLOOD DURING PERIOD OF MINE CLOSING**

**Tomuș Alecsandru Valentin<sup>1</sup>, Georgescu Mircea<sup>2</sup>**

**Abstract:** *The article presents preventive solutions for the isolation of areas at risk of rapid flooding to ensure the protection of the execution staff until the completion of the necessary works to close the underground mine. These consist either in leaving a protection/safety pillar in the rock of the area where the closure works are carried out, or in the execution of a concrete construction with the role of isolating the staged areas of the underground from the area with potential hydrodynamic manifestations of water.*

**Keywords:** *hydrodynamic isolation dam, safety pillar, allowable pressure*

### **1. INTRODUCTION**

In the current practice, the closure of a mine is achieved by retreating from the limit of the field of exploitation to the roads connecting with the surface.

When designing the closure of a mine, the possibility of water accumulation must be taken into account, either caused by the existence of aquifers in the deposit, or by its existence in old mining works or in geodes, or by the penetration of surface water (from a brook or river) [6].

These waters can cause rapid flooding of the galleries, thus endangering technical or human accidents.

In order to avoid accidents caused by underground hydrodynamic manifestations, it is necessary to find solutions to counteract the danger posed by water, by isolating the areas where the closure works are carried out with a protective screen.

Depending on the specific underground conditions of each mine, the following cases can be encountered [1]:

Case I: Leaving a protection/safety pillar in the rock of the area where the closure works are being carried out;

Case II: Construction of a monolithic concrete dam, equipped with an eruption valve (head) resistant to groundwater pressure from the depth at which the mining site is located.

---

<sup>1</sup> Ph.D. Eng. - University of Petroșani

<sup>2</sup> Univ. Prof. Ph.D. Eng.- University of Petroșani

## **2. SIZE OF THE ROCK SAFETY PILLAR**

- According to the paper [6] the width of the safety pillar is calculated with the relation:

$$h_p = 0.1 \cdot H + h + d \quad (\text{m}) \quad (1)$$

in which:

$h_p$  - width of the safety pillar (m);

$H$  - depth of the hearth of the mining work below the hydrostatic level (m); the depth of the floor is determined by the difference between the surface area and the share of the floor of the mining work. An average value of  $H$  is taken into account;

$h$  - height of the mining work in which the eruption can occur (m);

$d$  - represents the insecurity of the position of the work in relation to areas where it is possible to accumulate water; depending on the accuracy of the location of the old works ( $d = 1 \div 10$ ).

- After the paper [5] the width of the safety pillar is calculated with the relation:

$$h_p = 5 \cdot h + 0.05 \cdot H + 0.02 \cdot L \quad (\text{m}) \quad (2)$$

in which:

$h_p$  - thickness of the safety pillar (m);

$h$  - the height of the work in which the eruption is considered possible (m);

$H$  - depth of the floor of the mining work below the hydrostatic level (m); An average value of  $H$  is taken into account;

$L$  - the length of the mining work on which the personnel evacuation is made (m); An average value is taken into account.

In the sizing calculations we will work with the highest value of the safety pillar resulting from relations (1) and (2).

## **3. DETERMINING THE WATER PRESSURE ON THE PROTECTIVE SCREEN**

According to the paper [3] it is recommended to use Slesarev's formula:

$$p_a = 2 \cdot R_t - \gamma_p \cdot h_p - \gamma_a \cdot h_a \quad (\text{MPa}) \quad (3)$$

in which:

$p_a$  - permissible water pressure resisting the protective screen (MPa);

$R_t$  - tensile strength of rocks (MPa);

$h_p$  - width/thickness protection screen depending on depth (m);

$a$  - the width of the mining work (m);



- $\gamma_p$ – the volumetric weight of the rocks in the protection pillar (screen) to natural humidity ( $MN/m^3$ );
- $\gamma_a$  - volumetric weight of aquifer rocks at the degree of natural compaction ( $MN/m^3$ );
- $h_a$  - thickness of the aquifer (m).

#### 4. SIZING OF THE CONCRETE PROTECTION DAM

In the case of aquifer rocks, which can cause unexpected water floods, watertight dams will be built in adjacent areas, in galleries. These dams can be built of cast concrete, brick or precast concrete, and to take the pressure more easily they have different shapes: cylindrical, frustumconical, spherical.

In coal mines, the waterproofing dams can be: compact (solid), with access window or filters.

The most commonly used compact waterproofing dams can be made with one or more spurs.

In the following we will present the sizing of a truncated concrete dam made of cast concrete with a spur.

Concrete frustumconical (fig.1) are used in case of hydrostatic pressures higher than  $0.5MN/m^2$ . This type of dam is made with a resistance collar on the entire perimeter of the work.

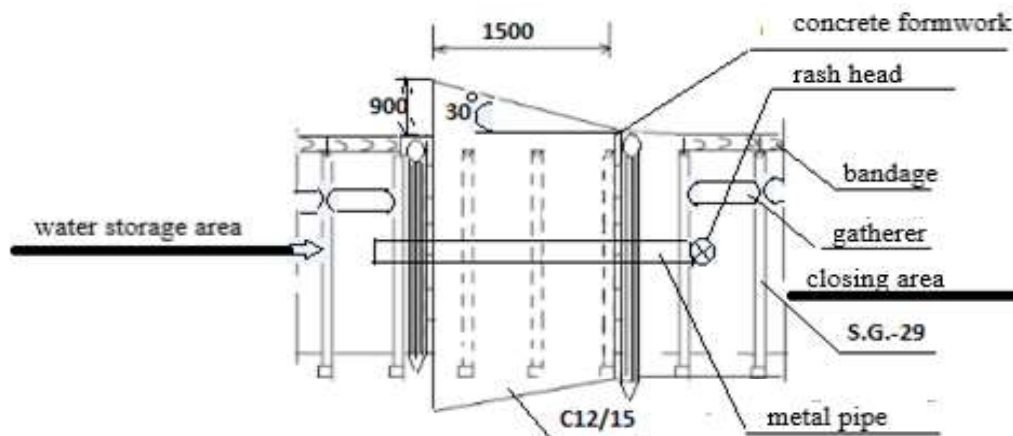

Figure 1. Diagram of a protective dam

The thickness of the frustumconical dam with a spur made of concrete,  $D$ , is determined by the relation [1,5]:

$$D \geq \frac{p_x \cdot r}{2R_{ac} - p_x} + \frac{a^2}{8r} \quad (m) \quad (4)$$

where:

$p_x$  - the hydrostatic pressure of the water acting on the dam, MPa

$$p_x = c \cdot p_w \quad (5)$$

$c$  - safety factor: 1.1

$p_w$  - the hydrostatic pressure of the water corresponding to the depth  $H$  (m) of the gallery where it is executed, MPa

$$p_w = \gamma_w \cdot H$$

$\gamma_w$  - volumetric weight of water, MN/m<sup>3</sup>

$r$  - inner radius of the dam (m),

In the horizontal section, depending on the width of the gallery floor,  $a$  (m), and the compressive strength of the rocks,  $R_c$ , the inner radius of the dam has the following values:

$$r = 2.0a, \text{ for rocks with compressive strength } R_c < 30\text{MPa}$$

$$r = 1.5a, \text{ for rocks with compressive strength } R_c \geq 30\text{MPa}$$

In vertical section the inner radius of the dam ( $r$ ) must be accepted depending on the height of the gallery,  $h$  (m) and the compressive strength  $R_c$ , as follows:

$$r = 2.0h, \text{ for rocks with compressive strength } R_c < 30\text{MPa}$$

$$r = 1.5h, \text{ for rocks with compressive strength } R_c \geq 30\text{MPa}$$

The angles of inclination of the planes of resistance of the dam to the longitudinal axis of the gallery are also chosen according to the compressive strength of the rocks,  $R_c$ .

$$\alpha/2 = 15^\circ, \text{ for compressive strength } R_c < 30\text{MPa}$$

$$\alpha/2 = 30^\circ, \text{ for the compressive strength } R_c \geq 30\text{MPa}$$

$R_{ac}$  - permissible compressive strength of surrounding rocks (MPa);

$$R_{ac} = 0.2 R_{rc} \leq R_b \text{ (after S. A. Feodorov)}$$

$R_{rc}$  - compressive strength of surrounding rocks (MPa);

$R_b$  - permissible compressive strength of the material from which the dam (concrete) is built, MPa;

The thickness of the frustumconical dam must be checked according to:

- Shear strength of the material in the dam (concrete)  $R_{afb}$  (MPa) with the relationship:

$$D_{Rf} \geq \frac{p_x \cdot a \cdot h}{2 \cdot l \cdot R_{afb}}, \quad (m) \quad (6)$$

where:

$l$  - perimeter of the dam, m

$$l = 2 \cdot (a + h) \quad (7)$$

$R_{afb}$  = permissible shear strength of concrete (MPa);

$$R_{afb} = \frac{0,2 \cdot R_{cb}}{s} \quad (8)$$

$R_{cb}$  - compressive strength of concrete (MPa)

$s$  - safety factor: 3

➤ The force of pressure on the rock,  $F_a$ , with the relation:

$$D_{Fa} \geq \frac{p_x \cdot a \cdot h}{R_{ac} \cdot l \cdot \sin \frac{\alpha}{2}}, (m) \quad (9)$$

In case of high pressures, when the thickness of the frustumconical dam exceeds 1.5 m, a dam with several spurs will be designed. In this case the relation (4) becomes:

$$D \geq \frac{p_x \cdot r}{2 \cdot N \cdot R_{ac} - p_x} + \frac{a^2}{8r}, (m) \quad (10)$$

where:  $N$  - number of rings/spurs of the dam;

## 5. CASE STUDY IN THE CONDITIONS OF THE MINES IN JIULU VALLEY

For the conditions of the mines in the Jiu Valley, taking into account the average values of the physical-mechanical characteristics of the rocks and the conditions of location of a dam, the width of the safety pillar and the thickness of a concrete protection dam are determined. The calculations are shown in Table 1.

**Table 1.** Determination of the width of the safety pillar and the thickness of the concrete protection dam

No. crt.	Calculation parameters	Symbol	U.M.	Calculation relation	The value of parameters
1.	Depth of the hearth of the mining work	H	m	-	150
2.	Height of the mining work (G.D.M.-8.0)	h	m	-	3
3.	Width of the mining work	a	m	-	4
4.	Perimeter of the dam	l	M	Relation 7	14
5.	Insecurity of the position of the work	d	m	-	3
6.	Length of the mining work	L	m	-	500
7.	Tensile strength of rocks	$R_t$	MPa	-	0,042
8.	Volumetric weight of the rocks in the protection pillar (screen) to natural humidity	$\gamma_p$	MN/m <sup>3</sup>	-	0 ,0264

9.	Volumetric weight of aquifer rocks at the degree of natural compaction	$\gamma_a$	MN/m <sup>3</sup>	-	0,015
10.	Thickness of the aquifer	$h_a$	m	-	8
11.	Compressive strength of surrounding rocks	$R_{rc}$	MPa	-	31
12.	Permissible compressive strength of surrounding rocks	$R_{ac}$	MPa	$R_{ac} = 0,2R_{rc}$	6,2
13.	Compressive strength of concrete (B200, Bc15)	$R_{cb}$	MPa	-	15
14.	Permissible shear strength of concrete	$R_{afb}$	MPa	Relation 8	0,6
15.	Inner radius of the dam	$r$	m	$r = 1,5a$	6
16.	Angle of inclination of the planes of resistance of the dam to the longitudinal axis of the gallery	$\alpha/2$	grade	-	30
17.	Volumetric weight of water	$\gamma_w$	MN/m <sup>3</sup>	-	0,01.
18.	Hydrostatic pressure of the water corresponding to the depth H	$p_w$	MPa	$p_w = \gamma_w \cdot H$	1,5
19.	Width/thickness of the safety rock pillar	$h_p$	m	Relation 1 Relation 2	21 32,5
20.	Permissible water pressure resisting the protective screen	$p_a$	MPa	Relation 3	1,99 for $h_p=21$ 5,10 for $h_p=32,5$
21.	Hydrostatic pressure of the water acting on the dam	$p_x$	MPa	Relation 5	1,65
<b>22.</b>	<b>Thickness of the frustumconical dam with a spur made of concrete</b>	<b>D</b>	<b>m</b>	<b>Relation 4</b>	<b>1,26</b>
23.	The thickness of the dam must be checked according to shear strength of the material in the dam (concrete)	$D_{Rf}$	m	Relation 6	1,18
24.	The thickness of the dam must be checked according to the force of pressure on the rock	$D_{Fa}$	m	Relation 9	0,46

## 6. CONCLUSIONS

Given that the usefulness of the proposed construction is limited to the duration of the implementation of the works to close the mine underground, it is considered sufficient to achieve the protection of workers by a protective dam with a single spur made of concrete 1.5 m thick, embedded in the walls of the mining gallery being met and the conditions imposed by relations (6) and (9).

The dam will be provided with a pipe to which a valve (eruption head) is mounted, dimensioned for the depth of the construction location and which will allow relaxation in case of hydrostatic overpressure on it [7] (fig.1).

## 7. REFERENCES

- [1] Cozma, E.- Tehnici și tehnologii de închidere și conservare a exploatărilor miniere, Petroșani, 2006;
- [2] Posea, N. - Rezistența materialelor, București, 1979;
- [3] Enache, C. - Asecarea zăcămintelor, Scrisul Românesc, Craiova, 1985;
- [4] Gheorghe, A, Bomboe, P, - Hidrologie minieră, București, 1963
- [5] x x x - Stroitelnie normi i pravila (SN:P), P.M4-65,Moskva, 1966
- [6] x x x - Manualul protecției împotriva apelor de mină, București, 1962
- [7] x x x - Proiect tehnic de închidere și ecologizare a minei Uricani, jud. Hunedoara, S.C. I.C.P.M.-SA Petroșani, 2011



## **EPOSIT OF USEFUL MINERAL SUBSTANCES - ECONOMIC RESOURCE AND FACTOR OF PRODUCTION**

**Mangu Sorin-Iuliu<sup>1</sup>**

**Abstract:** *The approached issue imposes the conceptual delimitation between two fundamental notions: “factors of production”, respectively “resources”. These notions designate two distinct categories of real economy entities, although the terms themselves are often used with the same meaning. In essence, the notion of “resources” expresses the state of availability of certain goods (tangible and / or intangible), without unambiguously associating them with a specific destination of use (such as, for example, production or consumption). By their simple existence, related to the production processes, the resources manifest the character of a productive potential. Under certain conditions, through appropriate decisions and actions, resources are activated, by attracting them in a concrete use, receiving a certain destination and thus becoming factors of production. The idea of specificity of each category of resources, both in terms of their intrinsic nature and the contribution they make to the production process, has led to the development of a representative typology of factors of production, considered in the variety of their forms of production existence, in a continuous expansion and diversification. In economic theory it is considered that the natural environment, in which all human activities take place, regardless of their specificity, was the source of the first resources attracted and used in productive processes. It is about natural resources and labor resources. For the mining industry, the resource of useful mineral substances, materialized in the form of the deposit, is decisive.*

**Keywords:** *mining branch, deposit of useful mineral substances*

### **1. CLASSIFICATION OF DEPOSITS OF USEFUL MINERAL SUBSTANCES**

The deposit of useful mineral substances represents "a deposit of useful minerals, formed naturally, which can be exploited in economical conditions" [11]. The economic performance of the exploitation of a deposit is directly related to the applied exploitation and preparation technologies, reason for which, the deposit can be defined as “the natural accumulation of mineral resources / reserves, exploitable from a technical and economic point of view” [12].

The study of deposits of useful mineral substances led to the use of several criteria for their classification, the most important being [7]: shape, industrial destination, genesis.

In the earth's crust, deposits appear in different forms. However, several general types could be identified, namely:

-stratiform deposits (delimited by two approximately parallel planes, concordant with the surrounding rocks and with great development in the direction);

---

<sup>1</sup> Lecturer Ph.D. Eng., University of Petroșani, [mangusorin@yahoo.com](mailto:mangusorin@yahoo.com)

-deposits with irregular shapes (appear in the form of accumulations with large extensions and thicknesses);

-vein deposits (resulting either by filling some gaps or underground cracks, or by depositing on the schistosity or stratification planes);

-lenticular deposits and in the form of nests (those that have a large and uniform development according to the three dimensions and whose intersections with some planes, which pass through the center of the deposit, are ellipses or curves close to the shape of the ellipse).

According to the industrial destination, the following are distinguished:

-deposits of metalliferous ores (ferrous metals, non-ferrous metals, light metals, precious metals, radioactive metals, rare and dispersed metals);

-non-metallic ore deposits (for metallurgical and refractory branch, for ceramic and glass branch, for chemical branch, for agricultural fertilizer branch, for electrotechnical and optical branch, for abrasives branch, construction materials, precious stones, mineral fuels).

According to the genesis, the deposits can be:

-endogenous (formed by processes related to the movement and consolidation of magmas, and which can be: magmatic - formed directly from magma, pegmatitic - formed by crystallization of magmatic residues rich in volatile substances, pyrometamorphic - formed by the action of volatile magma compounds on surrounding rocks, hydrothermal - formed from aqueous solutions, as magma differentiation products);

-exogeneous (formed on the surface of the crust, by the concentration of certain mineral substances resulting from rocks and deposits through their alteration processes, caused by the action of the atmosphere, hydrosphere and biosphere, and which may be altered deposits (residual and infiltration) and sedimentary (mechanical concentration, evaporation, chemical and biochemical deposition));

-metamorphogenic (formed by deep transformations undergone by pre-existing rocks in the lithosphere, under the action of temperature, pressure and chemical agents).

In the mining branch, the deposit is, at the same time, a product and an object of activity. During the initial knowledge phases (prospecting and exploration), the deposit represents the "product" of the mining activities, "the very particular economic good compared to another good" [11]. Subsequently, during the development and exploitation phases, the deposit represents the object of the mining activities, which aim at capitalizing the useful components from the structure of the deposit.

## **2. THE DEPOSIT - "PRODUCT" OF MINING ACTIVITIES**

Knowing a deposit of useful mineral substances involves going through the following steps [6]:

-identification and research of the deposit;

-research in order to establish the technological characteristics of the useful mineral substance from the deposit;

-elaboration of the technical and economic evaluation documentation of the possibilities of capitalization of the deposit;



-elaboration of technical-economic documentation for capitalization of the deposit.

The end of the first two stages is when sufficient information has been obtained to determine whether the agglomeration of useful mineral substances in the subsoil is a deposit. The third stage marks an evaluation process, which can validate the existence of a deposit of useful mineral substances, as an economic resource. The fourth stage enshrines the transition to the elaboration of documentation through which the deposit - economic resource will be transformed into a deposit - factor of production. It should be noted that throughout this process, it is not yet possible to speak of the field as a factor of production. Through research efforts, in which the contribution of the capital production factor is predominant, in the absence of which the information base necessary to substantiate the decision to move from one stage to another cannot be provided, a sufficiently accurate definition and knowledge of an economic resource is reached. , later transformable into a factor of production.

### ***2.1. Identification and research of the deposit***

At this stage, the geological research of the deposit takes place, which involves its prospecting and exploration. The geological research works are carried out in a certain sequence, imposed by the aim pursued.

The prospecting includes all the operations and works of geological, geophysical, geochemical, geobotanical research, with mining and drilling works, executed in order to highlight some concentrations of useful mineral substances in certain geological structures. In relation to the degree of deepening of research in a given geological structure, there is a distinction between preliminary prospecting and detailed prospecting. Preliminary prospecting is carried out on a small scale and aims to ensure general knowledge of the geological structure of a region and the delimitation, within it, of areas with different degrees of perspective in identifying concentrations of useful minerals. The detailed prospecting is carried out on a large scale and aims to ensure a sufficiently precise knowledge of the geological conditions in which the concentrations of useful mineral substances are found, so that, if necessary, the transition to the next stage can be technically and economically substantiated. field exploration.

The exploration includes all the works carried out in order to outline the industrial reserves of useful mineral substances and to specify their exploitable conditions. The exploration stage must provide all the information necessary for the quantitative and qualitative determination of the reserves of useful mineral substances, the determination of the utility of the deposit in the conditions of a rational exploitation and the design of the future mining enterprise. In relation to the purpose of the works and the degree of deepening of the research in a certain geological structure, there is a distinction between preliminary exploration, detailed exploration and exploration of preparation and extension. Preliminary exploration aims to obtain information to ensure the general knowledge of the shape of the deposit and the approximate determination of its reserves. It consists of less voluminous works, carried out on the whole area where the deposit is extended. The exploration of detail aims to obtain information that will ensure a more accurate knowledge of the characteristic elements of the deposit, so that

the reserves of useful mineral substances can be known accurately, both in terms of quantity and quality, and in terms of technological features. Detailed exploration may overlap with field exploitation. Exploration of the preparation and expansion takes place during the exploitation of the deposits, aiming at the preparation of the systematic exploitation in areas not yet exploited or in depth and providing the latest information about the structure of the deposit.

### ***2.2. Establishing the technological characteristics of the useful mineral substance in the deposit***

In order to determine whether or not a useful mineral belonging to a particular deposit can be recovered, a determination of its technological characteristics is required. This determination is made in parallel with the geological research of the deposit.

### ***2.3. Elaboration of documentation for technical and economic evaluation of the possibilities of capitalization of the deposit***

At the end of each stage of geological research, a synthesis geological study is elaborated, which includes the presentation, processing, systematization and interpretation of all data obtained in the previous stages, to which are added the data obtained in the phase for which the synthesis geological study is elaborated.

Geological studies together with technological studies provide an important part of the database necessary for the elaboration of technical-economic studies. The fundamental purpose of the technical-economic studies is to substantiate the decisions regarding the possible continuation of the geological research of the deposit until its last stage. The main technical-economic documentation are: pre-feasibility study, feasibility study, mining report.

The pre-feasibility study is the documentation in which a preliminary estimate of the economic viability of a deposit is made. This study is the basis for deciding whether or not to continue field research. Constituting the final result of a conclusive exploration stage, this study summarizes all the geological, technical, legal, economic, environmental and other information acquired on the deposit so far. For relatively advanced mining projects, the margin of error of the pre-feasibility study shall not exceed 25%.

The feasibility study represents the documentation in which the technical quality and the economic viability of the project of capitalization of a deposit are evaluated. This study is the basis for project financing decisions, while also representing the document that can be submitted to credit institutions when borrowing capital is requested. The study also allows for the relative verification of all project information.

The exploitation report represents the documentation in which the situation of the development and exploitation of a deposit until now is presented, as well as the future plans of exploitation of the deposit. This study is developed at the level of the mining company and includes information related to: the quantity and quality of useful mineral substances extracted from the deposit, changes in the economic viability of the deposit due to variations and fluctuations of costs and prices, development of appropriate

technologies. imposed new regulations, intrinsic exploration during operation. The study not only describes the current situation of the deposit, but also provides a detailed, accurate and up-to-date situation of the remaining reserves.

#### ***2.4. Elaboration of technical-economic documentation for capitalization of the deposit***

Based on the feasibility study, the technical and economic documentation necessary for the opening, preparation and exploitation of the reserves of useful mineral substances included in the balance group is further developed.

### **3. THE DEPOSIT - "OBJECT" OF MINING ACTIVITIES**

Once the deposit has become known enough to make the decision to capitalize on it, from the product of the mining activities it becomes their object, in the development and exploitation phases.

The transition to the execution of the opening works enshrines the character of a certain economic resource of the deposit, capitalizable in the existing technical-economic conditions. The exploitation of the deposit represents the phase in which it fully participates in the mining production, in its quality of fundamental production factor.

#### ***3.1. Development of the deposit***

The prospecting and exploration phases, which led to the establishment of the existence of reserves of useful mineral substances in the subsoil and to the shaping of the shape and extension of the deposit, are followed by the phase of the development works of the deposit.

The methods used for the development of the deposits are different, the choice of one of them, corresponding to a particular situation, being influenced by three main types of factors, namely [4];

- geological factors (geometric shape of the deposit, depth to the surface, thickness and inclination, degree of tectonization, hydrogeology and gas dynamics of the deposit, characteristics of the useful mineral substance and surrounding rocks, relief of the surface of the day, etc.);

- technical factors (annual production and duration of mine activity, industrial reserves of the mining field, shape and dimensions of the mining field, level of development of mining technologies, works and surface objectives to be protected from the influence of mining, etc. );

- economic factors (the level of capital expenditures, the duration of the opening of the deposit, the unit cost of exploitation, etc.).

Conceptually speaking, development usually follows directly after exploration and precedes exploitation. In a sense, however, development is an extension of the exploration phase to the exploitation phase. In reality, the phases of exploration, development and exploitation are intertwined, and a line between them is difficult to

draw. However, they all converge towards a valuable field, attracted in the economic circuit.

### **3.2. Exploitation of the deposit**

Depending on the nature of the useful components of the deposit, its exploitation takes specific forms. Thus, it is possible to carry out an exploitation by drilling (for useful fluid components), up to date (for sufficiently large deposits and confined near the earth's surface) or underground (for deposits located in the depth of the earth's crust). Each form of exploitation involves certain particular technical and economic aspects.

Some deposits of useful mineral substances appear on the surface (outcrop) or are located at a shallow depth in the subsoil, suitable for open-pit mining (in the quarry). Compared to underground operation, up-to-date operation has a number of advantages (higher labor productivity, lower number of accidents at work and occupational diseases, lower unit operating cost, the possibility of full mechanization and automation of production processes, use high-capacity machines, lower operating losses, the use of common materials, without special features, and much cheaper, lower unit costs, fewer staff, etc.), but also certain disadvantages (the influence of the seasons and of meteorological conditions on the production processes, high costs of evacuation of water from precipitation, affect much larger areas of land, costs of reconstruction of areas affected by the exploitation of much higher deposits, large initial investments in high-performance equipment, etc.).

In the case of underground mining, a distinction must be made between coal deposits (stratiform) and ore deposits (often other than stratiform).

The choice of methods of underground exploitation of coal deposits and their elements are influenced by a number of factors, namely: layer thickness, layer tilt angle, tectonics of the deposit, the tendency of surrounding rocks to collapse or bend, the position of the layers in the package. of coal, the presence of water in the deposit, the gas content of the deposit, the cleavage, the tendency of self-ignition of coals.

Compared to coal deposits, ore deposits have a number of peculiarities, which influence the method of exploitation applied, namely:

- the irregular mineralization of the deposit makes, most of the times, impossible a precise delimitation of the surrounding rocks;
- the mineralized area is, in most cases, harder than the surrounding rocks, which requires the use of explosive materials for the demolition of ore;
- the roof and bedrock, being generally compact, require other types of support (lighter);
- the exploitation of ores does not present the dangers represented by the potential explosions of the mine gases and the coal dust;
- ore reserves between natural boundaries are usually lower than coal reserves.

By exploitation, the field production factor, "product" of the previous stages of research and development, is consumed. At the same time, a series of mining works, a concrete, materialized form of the capital production factor, are either destroyed forever (in the exploitation process itself) or become unusable. Thus, a fundamental

characteristic of mining production is evident: the consumption of production capacities, created through previous investment and knowledge efforts.

#### 4. CONCLUSIONS

Probably from the point of view of particularities, no other branch of activity precedes the mining branch. Technological aspects (induced by the specificity of the processes by which an “agglomeration” of useful mineral substances is identified, researched and possibly “put into use”, confined, under certain conditions, in the earth's crust), superimposed over the particular mode of use and / or capitalization of mining “products”, more or less “finished”, determines even wider economic peculiarities. World mining practice has shown that a proper substantiation of decisions to use mineral resources can only be based on relevant criteria, which can be identified and quantified only when the economic approach to mining is limited to broad technological features.

A special situation, from the point of view of the use of capital and field production factors, is the cessation of exploitation (for economic reasons). Decisively, dealing with such a case raises particular evaluation issues. On the one hand, considerable amounts of capital remain fixed, in parallel with the cost of conservation and / or closure, and, on the other hand, it is difficult to quantify the social utility of restoring areas affected by mining or the opportunity to capitalize profitably in the future on some reserves of useful mineral substances characterized by certain conditions and quantitative and qualitative parameters.

#### 5. REFERENCES

- [1]. Almășan, B. – Exploatarea zăcămintelor minerale din România, volumul I, II, Editura Tehnică, București, 1984.
- [2]. Almășan, B. – Zăcăminte minerale: exploatare, valorificare, Editura Tehnică, București, 1989.
- [3]. Angelescu, C. (coordonator) – Economie, ediția a V - a, Editura Economică, București, 2000.
- [4]. Covaci, Șt. – Exploatări miniere subterane, volumul I, Editura Didactică și Pedagogică, București, 1983.
- [5]. Duchene, M. – Economie de l'entreprise miniere, Ecole Nationale Superieure des Mines de Paris, 1993.
- [6]. Hodor, P.; Dobrițoiu, N.; Simionescu, A. – Fundamentarea deciziilor manageriale în proiectarea minelor, Editura Universitas, Petroșani, 2000.
- [7]. Popa, A.; Rotunjanu, I.; Arad, V.; Gâf-Deac, I. – Exploatări miniere, Editura Didactică și Pedagogică, București, 1993.
- [8]. Simionescu, A. – Eficiența economică a investițiilor, Litografia Universității Petroșani, 1996.
- [9]. Simionescu, A.; Bud, N.; Biber, E. – Evaluarea proiectelor, Editura Economică, București, 2005.
- [10]. Simionescu, A.; Mangu S.I. – Microeconomie, Editura Focus, Petroșani, 2004.
- [11]. X x x – Economics of The Mineral Industries, Seeley W. Mudd Series, The American Institute of Mining, Metallurgical and Petroleum Engineers Inc., New York, 1964.
- [12]. X x x – Legea minelor nr. 85/2003.



## CONSIDERATIONS ON THE RENTAL SYSTEM IN THE MINING BRANCH

Mangu Sorin-Iuliu<sup>1</sup>

**Abstract:** *As a fundamental factor of production in the mining industry, the deposit must be remunerated. However, the reserves of useful mineral substances are exhaustible, and their supply is fixed on a global scale. Ownership and control over the reserves of useful mineral substances, the substantiation of their decisions to put them into use (for the exploitation of deposits), as well as the appropriation of the financial results of their profitable exploitation have become, in the conditions of global economic globalization, whose correct solution cannot bypass the conceptual-theoretical system of rent, as a form of remuneration of the deposit.*

**Keywords:** *mining, useful mineral deposits, rent, mining rent*

### 1. THE DIVISION OF THE RENT BETWEEN THE OWNERS AND THOSE WHO LEASE DEPOSITS FOR EXPLOITATION

In the mining branch, the way of renting differs from that of agriculture, because a clear distinction is made between the rents obtained through own efforts and those created “by the market”, as an object of the competitive struggle between the participants.

In the first case, it is an absolute rent, created and obtained as a result of the fiscal measures imposed by the state that owns the deposits of useful mineral substances.

In the second case there are differential annuities, as well as the so-called “temporary annuities”, obtained only in certain short periods of time. In both cases, for more or less known economic reasons, large fluctuations in the prices of mineral raw materials and energy are not taken into account. In fact, temporary or short-term rents are included in the absolute rent category because they are obtained by all owners of exploited deposits and occur as long as the prices of mineral raw materials are high. When prices fall, marginal mines begin to work at a loss, so that those who exploit deposits with more favorable geominer conditions acquire their differential rent, and also make a profit. Thus, the previously presented rents can be considered as “structural”, being obtained above the levels of short-term rents, which are all the higher as the exchange rate fluctuation on the foreign exchange market is higher.

Differential rents and short-term rents can be appropriated by the two main categories of participants: the owners of the deposits and those who have leased and exploited them. In practice, in most countries, the state plays the role of owner of deposits of useful mineral substances.

---

<sup>1</sup> Lecturer Ph.D. Eng., University of Petroșani, [mangusorin@yahoo.com](mailto:mangusorin@yahoo.com)

The principle of dividend income is quite simple because, without much difficulty, all participants and each of them get big gains in the event of favorable exchange rates, with which they can compensate for their losses during the period of decline. The state's fiscal policies, which provide for this way of dividing rents, can create difficulties in implementation, without fundamentally solving the problem of acquiring absolute rent.

The biggest difficulties arise in terms of appropriating differential rents considered as a "gift of nature", so income that can not be automatically attributed to one participant or another. In this case, the issue is the arguments that the two parties may have.

If the state owns the reserves of mineral resources in operation, it assesses the deposits, and therefore the differential income it will be able to obtain in relation to potential competitors. If there is competition between the state and the capital holders, the state has the power to appropriate its entire differential rent. Moreover, sovereignty over marginal mines prevents them from being mined if the state cannot obtain a minimum income to cover its mining costs. In other words, when it comes to the reconstruction, at least in theory, of marginal mines, the deposits from which a differential rent and an absolute minimum rent can be obtained are taken into account.

If the fundamental long-term goal of mining companies is to recover the invested capital, the following problems arise.

From the entrepreneur's point of view, it is normal for most of the rent to go to him, to cover at least the technological research expenses he has incurred and the infrastructure he has built, as well as for the so-called risk premium justified by the exploration activity, which is much more risky than any type of industrial activity. The problem then arises that the rate of profit from the activity of discovering new reserves is higher than that of the actual exploitation. Such a conception is based on the fact that the investor has the merit, at least in part, of discovering a deposit of mineral resources without state money, this deposit being previously practically unknown. If investment firms impose this view, there is a danger that, at least locally, there will be a high rate of return on successful exploration operations. In this way, the average rate of profit per branch will be higher than in other branches of industry, with lower risks, without the market price exceeding the cost of production of marginal mines. Otherwise, it means that the expectation of profit, mathematically speaking, is not higher in the extractive branch than in the other lower risk branches, which will lead investors to change their mind to explore new perimeters. There are opinions that this part of the rent will have to return legitimately as a mining rent to those who exploit the respective deposit, because this activity has a high degree of risk.

From the state's point of view, it appears legitimate for companies to claim an average (normal) return on capital invested directly in state deposits, but it is debatable that these companies claim a share of the rent determined by the quality of the deposit, the quality of natural capital, a part that is, in fact, a risk premium, difficult to assess, but which is used practically for exploring the whole territory.

The state is entitled to adopt such an attitude, rather than wait for the moment of exploitation of the deposit by a national public enterprise, which will own the entire differential rent. These two positions are contradictory, which requires finding a



compromise for the division of the differential rent: how much should go to the company that invested in the exploration and evaluation of the deposit and how much should go to the state. In practice, this compromise materializes in various forms of tax provisions, such as provisions for the reconstruction of deposits, which allow companies to provide certain deductible amounts of taxable income, provided that they will be reinvested locally. This type of compromise will not fully resolve the conflict. In reality, the share of the investing firms and the share of the state depends on the balance of power between the two parties, as well as on the multitude of factors, such as the ability of each to surpass the other or to place it at a lower level in the fight. competitive market. These factors are influenced by the political and geopolitical environment, but especially by the way in which foreign capital can be attracted for investments in the mining branch.

The consequences of dividing rents differ from country to country and from field to field. In general, companies are not interested in the level of operating cost of a deposit itself, but in what they get after the sale of mining products, respectively after the payment of tax obligations. Thus, if the producing countries have deposits with the best geo-mining conditions, they will obtain different forms of rent, the exploitation being made either by private companies or by public companies. If the governments of those countries want to make their capital profitable, they will focus on low-tax areas, even if production costs are higher and the risks in exploiting these deposits are higher. In this area, the state retains most of its rent because it assumes the risk of geological research, the intensity of which depends on its own long-term development strategies and policies. In these conditions, it can be appreciated that the way of dividing the rent by geographical areas explains in detail the ways of exploiting the reserves of useful mineral substances, which, in turn, will influence the structure of the future supply. Thus, if the producing states retain a large part of the rent, without reinvesting it in exploration, so without allocating it to cover the costs of basement research and the risks assumed by companies specializing in geological research, the extractive branch cannot be self-financing. Without an infusion of capital from outside this branch or from government authorities, so from external risk assumed by them, the exploration activity will be insufficiently financed from within the branch, due to lack of capital, the volume of discovered reserves will gradually decrease, which will causes an accentuated shortage of raw materials and energy, and implicitly, will lead to the appearance and / or accentuation of the economic imbalances.

To eliminate such imbalances, countries with reserves of mineral resources charge a price called the "right of exploitation", which, in theory, is equal to the current value of future revenues that are expected to be given to investors, so the discounted value of rent "[6]. But the value of these rents is impossible to predict with precision, the actual cost of operating a deposit reflecting, in fact, the participants' forecasts regarding the evolution of prices for extracted useful mineral substances, as well as the evolution of fiscal policies and all factors that may influence the size of the rent. future.

In conclusion, differential rents will always exist, but their mode of division and appropriation, according to microeconomic logic, is influenced by political and geopolitical factors, as well as the level of competition between processing industries and owners of useful mineral deposits. Geographically, the distribution of rent is influenced by the profile companies, depending on their exploration objectives, so the

change in a certain time horizon of the offer, which, in turn, depends on the production of marginal mines, their importance and place of location.

## **2. MINING RENTS AND TAX LEGISLATION IN ROMANIA**

If at the microeconomic level, the issue of mining rents is solved from a theoretical point of view, we cannot say that at the macroeconomic level things are the same.

In Romania, according to the Constitution, the mineral riches of the subsoil cannot be the object of private property, but only of public property. However, they can be put into use by private companies. In other words, the legal framework has been created that regulates the participation of private capital both in the activities of mining prospecting and exploration, as well as in those of development and exploitation of deposits. In fact, at present, authorized voices suggest that the very survival of Romanian mining is related to the way in which it will manage to attract private capital.

The current mining law has established a system for taxing mining activities. This system does not take into account the origin of the capital of the mining operators and has two fundamental components: one that takes the form of taxes in a fixed lump sum and another of the nature of the royalty.

The amount of taxes accompanying mining activities has been set at the following basic levels, updated in relation to the inflation rate:

- for prospecting activity, 2.50 RON/km<sup>2</sup>;
- for the exploration activity, 10.00 RON/km<sup>2</sup> (the value doubles after 2 years and becomes 5 times higher after 4 years);
- for the exploitation activity, 2,500.00 RON/km<sup>2</sup>.

The mining royalty was set as a percentage of the value of mining production, differentiated by categories of useful mineral substances, namely:

-5% for ferrous, non-ferrous, aluminum ores and aluminous rocks, radioactive metals, rare and dispersed earths, precious and semi-precious stones, mining residual products, bituminous rocks;

-4% for coal;

-6% for precious metal ores;

-the equivalent in RON of 0.875 EUR per mining production unit, for non-metallic substances;

-the equivalent in RON of 0.4375 EUR per mining production unit, for igneous rocks, metamorphic rocks, industrial and construction limestones, dolomite, sandstone and industrial tuffs;

-the equivalent in RON of 0.50 EUR per mining production unit, for clays, marls, loess, sand and gravel, sand and kaolin rocks;

-the equivalent in RON of 0.6875 EUR per mining production unit, for industrial alabaster, pumice stone, nepheline syenites, gypsum, chalk, siliceous sand, bentonite, kaolin sand, slate and diatomite;

-the equivalent in RON of 2.5 EUR per mining production unit, for ornamental basalt, ornamental dacite, ornamental rhyolite, ornamental granite, ornamental granodiorite;

- the equivalent in RON of 3,125 EUR per mining production unit, for ornamental alabaster, ornamental aragonite, ornamental siliconites;
- the equivalent in RON of 3.75 EUR per mining production unit, for marble, ornamental limestone, ornamental tiles, travertine, ornamental tuffs;
- the equivalent in RON of 1.0 EUR per mining production unit, for haloid salts.

From a fiscal point of view, mining companies are not given preferential treatment. In addition to the current tax burdens, they are also subject to the tax system set out above. Regarding this, at least two aspects can be invoked: the lack of a rigorous scientific basis for establishing the amount of these taxes, respectively the way in which they are spent by their collectors (National Agency for Mineral Resources, respectively the State Budget).

### 3. CONCLUSIONS

The theory of income distribution (from microeconomics) shows that the process of setting the prices of production factors is not at all different, conceptually and methodologically, from the process of setting commodity prices, all types of market structures remaining decisive. In addition, the Euler and Clarck-Weackstead-Walras theorems (called the "product depletion" theorems) show that the remuneration of one factor of production is never to the detriment of others.

Among the income generated by the use of all the factors of production, a special place is occupied by rent. Due to its long existence, rent is one of the most widely used economic concepts with the most different meanings. For a long time, rent was attached to the use of natural resources, especially land. In modern times, however, the scope of this notion has been extended to other factors of production.

In Romania, the development of the mining industry was not based on too many considerations of the nature of economic efficiency, and the theoretical developments regarding the costs generated by the use of production factors were ignored.

However, the correct substantiation of the decisions regarding the use of the national mineral potential cannot ignore the costs generated by the remuneration of the deposit production factor through the mining rents system (such a basis is urgently needed).

As a factor of production, the deposit has a special feature: fixed supply (perfectly inelastic or very slightly elastic). This particularity requires the consideration, in the process of setting prices, of the concepts of opportunity cost and economic rent. The less elastic the supply, the higher the economic yield of the factor of production. When the supply is perfectly inelastic, the full remuneration of the factor of production is rent.

With agriculture as a benchmark, David Ricardo addressed the issue of land rents, developing the concept of differential rent. The conclusions reached by Ricardo and the concept itself are also applicable to the exploitation of deposits of useful mineral substances (where the diversity of conditions and characteristics is greatly amplified in relation to the categories of agricultural land).

Over the last 50 years, the growing importance of the mining industry has led to growing concerns about rents. Theoretical support has been developed and its

applicability has been extended. The concepts of monopoly rent, absolute rent and depletion rent have become common in the works on the economy of the mining industry. Unfortunately, the same cannot be said about Romania.

Problems of the nature mentioned in this chapter can only be solved by starting from the form of ownership of mineral resources in Romania and taking into account the experience of states rich in publicly owned mineral deposits (such as the Russian Federation, for example). In this regard, a model for identifying and determining the size of annuity components should be devised. In accordance with internationally agreed views, the exploitation of publicly owned mineral deposits should provide compensation for:

- the land removed from the economic circuit as a result of the mining activities (at the level of the profit that the best use of the land would bring, in the conditions of an average agricultural or forestry production), therefore a rent of the land;
- damage caused to the land as a result of mining activities (especially affecting water sources and plant material), at the level of additional costs that would generate a land use identical to the previous one, so a rent of the "damage" of the who loses;
- the entire people who own the reserves (at a level that remains to be discussed), so a civil rent;
- depletion of reserves, taking into account their non-renewable nature (what has been exploited will not be restored in historical times), so a rent of depletable resources;
- the owner of the capital who invests it in the mining branch, thus stealing it from other uses, so a mining rent.

Even if the establishment of the current system of taxation of mining activities in Romania were perhaps similar considerations to the previous ones, the lack of clear specification of the destinations of financial resources accumulated at the level of state bodies with responsibilities in the field make the system unproductive in its current form. In developed mining countries such a system was conceived in favor of the branch, but in Romania this goal is far from being achieved.

Regarding the presented ones, some conclusions can be drawn:

- the mathematical model for calculating the rent must be based on consolidated macroeconomic indicators, which reflect the overall efficiency of the national mining industry;
- the mechanism for establishing and collecting rents is not possible to function effectively if it is isolated from the mechanism of rent distribution at national level;
- each citizen is a co-owner of the national mineral wealth and is authorized to obtain (in the form of works and actions of public interest initiated by the central authority) the due part of the mining rents;
- the issue of rents related to the exploitation of deposits is complicated and must be seen in the light of the new existing relations at international level, between the owners of resources and those who exploit them;
- a special training in the field of mining rents is necessary, but Romania has not made any effort in this direction.

#### **4. REFERENCES**

- [1]. Angelescu, C. (coordonator) – *Economie*, ediția a V - a, Editura Economică, București, 2000.

- [2]. Brown, L. (coordonator) – Eco-Economia, Editura Tehnică, București, 2001.
- [3]. Cole, G.A. – Management: teorie și practică, Întreprinderea Editorial-Poligrafică Știința, Chișinău, 2004.
- [4]. Gherasim, T. – Microeconomie, vol. I, II, Editura Economică, București, 1993.
- [5]. Heyne, P. – Modul economic de gândire, Editura Didactică și Pedagogică, București, 1991.
- [6]. Răducanu, V. – Economia resurselor naturale, Editura All Beck, București, 2000.
- [7]. Samuelson, P. – L'Economique, volumes I, II, Editeur Armand Collin, Paris, 1982.
- [8]. Simionescu, A.; Mangu, S.I. – Microeconomie, Litografia Universității Petroșani, 1999.
- [9]. X x x – Legea minelor nr. 85/2003



## PRECIOUS METALS STOCKS INVESTMENTS. STATUS OF PRECIOUS METALS IN ROMANIA

Tiuzbaian Ioan Nicolae<sup>1</sup>, Hulea Lavinia<sup>2</sup>

**Abstract:** *Although it was officially demonetised, gold (precious metals, generally speaking) preserves the attributes that turn it into a currency: it is relatively easy to store and carry, may be available as pieces of various values, it is difficult to falsify, so that it is easily recognisable and checkable and, in addition, it is widely accepted. At present, more than ever, gold stocks investments display a series of advantages, which Euro or Dollar investments do not provide.*

**Keywords:** *precious metals, investments, investment process, capitalising, precious metals operations*

### 1. PRECIOUS METALS STOCKS INVESTMENTS

Precious metals stocks investments or the gathering of stocks of precious metals are considered to be those gold acquisitions that are not made with a view to match a practical need but in order to carry out other goals such as: preserving money savings in a safer manner, targeting speculative purposes or exhibiting a real passion for the noble metal.

In a recession-prevailing economy where investment processes seem insignificant and display no relevance for the economy, gold is still the traditional manner of investment with an intrinsic value. Contrary to other investments, such as: bank deposits, governmental credit titles or companies shares, gold investments (stocks) trigger the confidence given by real value.

It is estimated that, in 2020, the most important five gold mines in the world, by production, were the following ones: Newmont (based in Colorado, U.S.A., with exploitations in Australia, North and South America, Africa), Barrick Gold (operational in North and South America, Africa), AngloGold Ashanti (based in South Africa), Polyus (Russia), and Kinross Gold (based in Canada).

The world gold reserves represent about 53,000 tons, while the mined gold in 2020 dropped to 3,200 tons, which means a 5% decrease determined by the Covid-19 pandemic. Nonetheless, the benefits from gold mining do not show a decline as investments in gold appear to be on the rise in the context of a downturn in traditional financial markets.

A series of less known data about gold are further displayed:

- 80% of all gold has not yet been detected;

---

<sup>1</sup> Lecturer Ph.D. University of Petrosani

<sup>2</sup> Lecturer Ph.D. University of Petrosani

- Specialists consider that gold brings benefits to humans as it slows down body's aging;
- The chemical symbol for gold is Au, originating in the Latin word *aurum*, which means *shining dawn*;
- Residual marks of gold have been found in the leaves of eucalypts;
- Nowadays, Olympic medals contain only 1.34 % gold, namely about 6 grams. The only Olympic medals made entirely of gold were the ones in 1912;
- Croesus, the King of Lydia (a kingdom in the Western part of Asia Minor) created the first pure gold coins, at around 540 BC;
- 75% of the total amount of gold in circulation today was extracted beginning with year 1910;
- Gold is so rare that more iron is extracted per hour than the gold mined from the beginning of written history;
- During the 15<sup>th</sup> century, molten gold was used to treat bubonic plague;
- Gold and copper are the first metals discovered by man, around 5000 BC;
- Ancient Greeks believed that gold was an extremely dense combination of water and sunlight;
- The largest piece of gold worldwide is a gold brick of about 250 kg;
- Certain scientists assert that almost all the gold on Earth comes from the meteorites that had fell on the planet about 200 million years before;
- The human body contains around 0.3 milligrams of gold, most of it in human blood;

Although it has been officially demonetized, gold (precious metals, in general) preserves the attributes that turn it into a currency; it is relatively easy to store and carry, it is available as pieces of various values; it is hardly falsifiable, so that it is easily recognisable and checkable, and, in addition, it is widely accepted.

Nowadays, more than ever, gold stocks investments display a series of benefits, which Euro or Dollar investments do not provide. Gold cannot be depreciated by governments through inflation as it is the case of currency, which can be printed, if required, in unlimited amounts.

During the periods of economic incertitude, gold inspires confidence more than any other currency due to the fact that history has proved that, unlike currencies, gold value is preserved in time, surviving wars, natural calamities or economic and social crises. This is the reason why more than 80 states preserve, at present, important gold reserves, although no country can actually cover or guarantee its national currency in gold.

This economic truth should determine the governments to capitalize their gold deposits so that, through increasing the gold reserve they could more easily compensate the recession of national economy and maintain stable the value of national currency protecting it against inflation.

Gold stocks investors, either individuals or legal persons (including governments) rely mainly upon three manners of investment, namely: buying a certain amount of metal; buying the stocks of a mining company that exploits gold or making term transactions with precious metals.



Buying gold, as an investment in a metal stock, can be done either through bullions and/or through currencies. A bullion is a parallelepiped of fine gold (chemically pure – 99.999% or 24 karat), bearing the mark (imprint) of the purification unit it originates in as well as the mark of purity and its weight.

On gold markets, ten standard sizes of bullions are traded, which have their weight (value) adapted to the investors' various possibilities of buying.

The smallest bullion is the small plate of a quarter of an ounce (about 8 grams) meant for small investors. Further, the plates or bars of increased weight address to those investors whose possibilities are higher and who would like to buy more.

The largest bullion is the traditional one of 400 ounces (about 12.5 kg), which, the connoisseurs call Good Delivery Bar; it is similar to a brick and represents, in fact, the main item of important transactions.

Such bullions have as a unique destination treasury collecting; consequently, they are bought both by legal persons (including governments) and by individuals, although they generally appear to be uncomfortable for this category.

The second form of investment in gold stocks is done through gold coins which are pieces of various sizes and weight bearing inscriptions and marks on both sides in order to be easily recognizable. Coins contain either pure gold of 24 Kt (Kruggerand) or alloy gold; they can be grouped into two categories: numismatic coins and treasury coins.

Numismatic coins are the old ones, emitted centuries ago when, in fact, they circulated as a value measure, namely as money. At present, their value tremendously overpasses the value of the gold they incorporate due to the fact that they are not only evaluated for the gold they contain but for their historical and artistic value and for their rarity.

Numismatic collections consequently figure among the most valuable world collections. Such pieces represent documentary portraits of the past for contemporary historians. The coins used in order to be collected as treasuries (bullion coins) are coins emitted during the last period of time, mainly in our century. They are meant for investors who want to preserve small amounts of gold.

A lot of investors prefer coins instead of gold plates, bars or bullions, due to the fact that they may be preserved and recognized (evaluated) more easily; accordingly, gold coins are always more easily capitalized than plates or bullions, which have to be checked by an expert in order to state whether the purity and weight marked on them is real.

Treasury coins are also evaluated at a higher price than the value of the gold they contain. According to the specialized language of the business, it is said that treasury coins are premium.

In case of treasury coins, such a premium characteristic represents only a fraction of their value (ranging between 5 and 20%) unlike the premium characteristic of numismatic coins.

On the contrary, gold plates, bars or bullions are sold according to the value of the gold they contain, with no premium characteristic.

The most widely known and used treasury coin is South Africa's Kruggerand, which was first emitted in 1967 and weighs an ounce of 24 Kt of fine gold.

The other two gold coins known and used at present for treasury collecting are re-emissions of former coins, namely: the modern replica of the 4-ducat piece of the former Austro-Hungarian Empire and the 50-peso piece of Mexico. There are still other countries which re-edit nowadays, intermittently, gold coins, which once officially circulated: Switzerland, Turkey, France, England, etc.

In 1975, 1976, and 1977, the Soviet Union launched for sale on world markets over one million gold coins called *cervoneti*, which were replicas of the former gold coin of Russia and weighed 7.7 grams.

Likewise, in 1976, on the occasion of the Olympic Games in Montreal, Canada emitted 9,000 gold pieces, each of which representing the 100-Canadian dollar piece.

Certain Arabian countries such as: Kuwait, Syria, and Saudi Arabia, struggle to get reproductions of old official coins both belonging to their countries and to other ones. Such coins are rather considered jewels as they are meant for the golden necklaces displayed as jewellery in those regions.

While the stocks of bullions and gold bars are exclusively meant for treasury collecting, the stocks of gold coins have a more diversified destination. Part of the gold coins belonging to individual stocks represent numismatic or art collections.

Coins are considered both jewels and ornaments and in certain countries the preservation of gold coin necklaces is part of local customs. Yet, one may ultimately consider that stocking gold coins (especially when considering important amounts of the same kind of coin) is similar with treasury collecting due to the fact that it determines the deviation of the golden metal from its practical use.

Buying gold in order to collect treasury is typical for the periods of economic incertitude. Accordingly, economic recession started in 1974 as well as the energy crisis that followed determined the continual increase of individuals' demand for bullions and bars. In 1974 it represented 664 tons, overpassing the 1968 record when markets witnessed the depreciation of British pound that determined private companies and individuals to massively buy gold.

In 1970 and 1972 the Western central banks made a huge gold buying representing 238 tons, respectively 151 tons, in order to get back the gold sold to individuals during the period 1967 – 1968.

Beginning with 1973, all gold buying for treasury collecting were made by individuals, attaining high amounts, as a result of the acceleration of inflation and of the crisis phenomena in the worldwide economy. In 1973, individuals' gold acquisitions for treasury collecting represented 578 tons out of which only Europe detained over 300 tons.

As a result of the increase of gold price during the last years of the second millennium and at the beginning of the third one, one may notice private investors' tendency to buy gold for treasury collecting, mainly as bars and plates, and, to a limited extent, as bullions of 6 and 12 kg.

Buying the shares of a gold mine represents the second manner of investing in the gold metal. The trend of such shares follows, as a rule, gold price, and the dividends paid by the emitting mining company depend on the profits determined by exploitation.

Acquiring the shares of gold mines is a riskier investment than buying fine gold. The hereby statement relies upon the reasoning according to which production,

production costs, and the richness of the mineral deposit are elements which cannot be exactly predicted and, consequently, the efficiency of a gold mine may take unexpected turns.

Gold term transactions operations represent the third manner according to which investments in stocks of precious metals may occur. Such operations are made by the stock exchanges that trade precious metals.

Term contracts allow the owner to buy or sell a previously determined amount of precious metal at a future moment and at a settled price. The operation is carried out owing to fictive amounts of gold and does not necessarily involve the physical evidence of gold.

The prices and delivery terms are determined according to the relation demand-offer that comes out of the anticipations and speculations of the business environment involved in such transactions. Term transactions have a high degree of 'swing' that may positively or negatively influence the entities involved in transactions; they might be sometimes extremely profitable, yet, at times, they may be catastrophic.

One may state in connection with this type of investment that it is, to a great extent, a speculative one and it consequently implies the responsibility of an important risk. With these in view, let's notice the significant ample speculations that accompanied gold and silver fever during the winter of 1978-1979, which determined the bankruptcy of the billionaire magnate Nelson Bunker Hunt, from Texas.

## **2. STATUS OF PRECIOUS METALS IN ROMANIA**

Order no. 190/2000 of the government settled the legal status of precious metals on the Romanian territory. According to this order, the individuals and legal persons have the right to buy and detain no matter what amount of objects, jewels, coins with or without power of circulation, irrespective of the fact that they belong or not to a numismatic collection, as well as other objects made of precious metals, including bullions and bars.

Buying and selling activities or precious metals transactions are also free of restrictions - except for those dealing with financial gold or with investments - on condition that such trading represents a permanent or professional activity.

Precious metals operations made by individuals and legal persons and which represent permanent or professional activities can be only carried out according to a license issued by the Ministry of Finances for a determined period. Financial gold operations or those dealing with investments carried out by banks are valid only on the basis of the authorization issued by the National Bank of Romania.

Individuals and legal persons may bring to or take from Romania jewels and personal objects made of precious metals within the margins and under the terms stipulated by customs regulations in force.

The registering of precious metals operations is compulsory in case of the individuals and legal persons authorized to buy, detain, and carry out operations with such metals as well as in case of the individuals and legal persons belonging to the field of manufacturing jewels, medals, handicraft ware, art woks, religious items, medical works.

With a view to preventing illicit trade, the objects made of precious metals, jewels, as well as non-manufactured golden and silver items which are imported, exported or sold are compulsorily marked in Romania and bear the guarantee mark of the manufacturer, exporter or importer.

Consequently, the National Marking Office has been founded under the jurisdiction of Romania's government; its main goal is the marking of precious metals with the legal verification mark of the Romanian State, the analysis and expertise of precious metals.

The control of precious metals operations is exerted by the representatives of the Ministry of Finances, of the National Marking Office, and by those responsible with control at the level of the National Bank of Romania, in case of the investments made by banks.

The size of the national gold reserve as well as the level of external transactions of the State is the responsibility of the National Bank of Romania.

### **3. REFERENCES**

- [1]. Abrudeanu, I., Rusu, I. 1933. *Aurul romanesc*, Cartea Romaneasca Publishing House, Bucharest.
- [2]. Biber, E., Tiuzbaian, I., Hulea, L. 2013. *Precious Metals Stocks Investments. Theoretical Grounds - Annals of the University of Petrosani, Mining Engineering*, vol. 14.
- [3]. Biber, E. 2000. *Eficienta economica a investitiilor*, Culegere de exemplificari practice, INFOMIN Publishing House, Deva.
- [4]. Haiduc, I. 1940. *Industria aurului din Romania*, Imprimeria Adevarul Publishing House, Bucharest.
- [5]. Haiduc, I. 1938. *Productia si comertul cu aur si argint*, Diecezana Publishing House, Arad.
- [6]. Lazarescu, I., Barna, V. 1972. *Aurul si argintul*, Technical Publishing House, Bucharest.
- [7]. NS Energy, <https://www.nsenegybusiness.com/#>, 2021

## **ENERGY ASSESSMENT OF COAL IN THE CONTEXT OF ENVIRONMENTAL PROTECTION**

**Bădulescu Camelia**<sup>1</sup>

**Abstract:** *The coal has still an important weight within the energetically resources balance used for producing electric power but its expending in last decades has been limited due to the fact this is a major polluting source for atmosphere but also for water and soil. Reducing of atmosphere pollution as result of burning the solid fossil fuels is possible to be performed also before burning by using adequate mechanical processing technologies. Sulphur is found mainly in coal fractions, which makes more complicated to remove it by means of common processing procedures, for this reason being required to be selected adequate processing diagrams, and additional cost must be supported from financial sources afferent for environment protection.*

**Keywords:** *SO<sub>2</sub> content, environmental protection, coal, mechanical processing technologies.*

### **1. INTRODUCTION**

Power stations using the coal as energetically agent exhaust into the atmosphere large quantities of polluting agents having different forms. Burning of coal involves pollution of environment by means of powders exhausted from chimneys and by means of flying ash spoil dumps.

Mechanical pollution is completed by chemical pollution produced as result of action of chemical substances in burned gases that can be even more dangerous than the solid ones, affecting the ecological balances of areas around the energetically complexes.

In order to reduce the impact of gases onto the environment is required that in the future to be taken a range of measures aiming to monitor the noxious gases exhausted complying the national and international environment protection laws.

It is very important to perform the estimation of modernization level of coal processing plants and of power stations in regarding environment impact.

### **2. RESEARCH TRENDS AND PROPOSAL FOR IMPLEMENTING NEW TECHNOLOGIES WITHIN EXISTING COAL PROCESSING FLOW SHITS**

Taking into account the objective the present paper will refer further on only to polluting component SO<sub>2</sub>.

An important characteristic of hard coal is the total sulphur content that exceeds the limits in environment legislation. The raw coal has total sulphur content between 1.5 – 2.5 %, and the processed coal this value increases depending on the ash

---

<sup>1</sup> *Assoc.Prof.Ph.D.Eng. University of Petrosani, E-mail: badulescu\_c@yahoo.com)*

content, up to 2.0 – 3.0 %. The waste resulted from processing activity has total sulphur content of 0.6 – 1.4 %. It can be noticed that for processed coals there is higher content of sulphur and less ash than the raw coal. This fact justifies the specific distribution of sulphures within the mined material: the sulphur content of organic material (combustible) is much higher than mineral substance (non - combustible).[3]

The system recommended by specialized literature for estimation of coal quality and especially of thermal coals can be based on calculated conventional index of sulphur dioxide emissions. This index shows how much sulphur dioxide is exhausted during a burning process generating 1 KJ of heat, considering that entire sulphur quantity represents fuel with 100 % efficiency for all components in this fuel.

For the raw coal with sulphur content of 1.84 %, value of this index has been calculated as 0.220 mg SO<sub>2</sub>/kJ.

For a mixture of technological coal products that have offered to consumers a thermal coal with sulphur content of 1.13 %, the calculated convention of index of sulphur dioxide emissions had the value of 0.326 mgSO<sub>2</sub>/kJ.

Concentration of pyrites in not processed coal and the waste resulted from raw hard coal washing varies between 64 – 75 %. These values can suggest that by removing the sulphur out from mined material – removing of pyrites – this should be performed in the same time with reduction of ash content. Although coal processing by means have mechanical separation has no efficiency due to the fact that pyrites are present in fine grains existing in solid fuel material being included in non-separable ash. This fact has been proved by means of microscope tests.[4],[6].

Another important characteristic of hard coal, having a major influence in the case of thermal processing, is represented by volatile material content, due to the fact this procedure involves removal of large quantities of combustible gases.

Volatile content shows the degree of metamorphism of hard coal and this is conditioned by petrographical composition, being expressed by means of large content of vitrinit in comparison to a low content of inertit.

Analyses performed on representative samples of superior coal product obtained by means of coal processing have emphasized values of volatile content between 40 – 44 %; in case of not processed coals and of coal waste this value can reach 50 – 63 % reported to combustible material.

Sulphur content of analyzed coals is high, and distribution of this sulphur into the combustible mass makes difficult to remove them by means of classical methods (mechanical cleaning-imposed for reduction of ash).

In order to use these coals as fuel, they should include sulphur removal processes or de-sulphuration of burnt gasses, even for the case these coals are planned to be used in local heating stations.

The most superior capitalization may consist in production of ecological fuels or city heating systems or household purposes, under the coking type or semi – coking coals briquetted with bituminous or ecological binder. A possible option is hot briquetting of coal preceded by removal of smoky volatiles and utilization of a special coal with good agglomeration properties as binder.

Mechanical ash cleaning down to ash content below 10 % and chemical removal of sulphur with natrium hydroxide melted at temperature of aprox. 400<sup>0</sup> C

represents a de – polluting technology that can reduce the sulphur content of the fuel obtained below 0.5 %.

A last variant mention and that can represent the object of researches and conclusion works afferent for adequate technology, refers at co – gasification of hard coal under pressure with urban solid waste, process that can provide complete gasification of organic matters in waste and coal and in the same time vitrification of ash into a non polluting type.[5].

Among the mechanical processing technologies used for decreasing SO<sub>2</sub> content in gases exhausted into the atmosphere, the following can be studied in the next stage:

- obtaining coal mixtures in the way that the concentration of polluting substance not to exceed acceptable limits;
- selective separation of densimetrical coal size classes having lower sulphur content and dosage into the selling coal product in order to obtain a less polluting fuel;
- grading of coal middling, concentration in installations that are specific for fines and mixing of final products with sulphur inorganically acceptors;
- possibility for usage of carbolitic for crushed middling or for fine coal in raw coal.[6].

All researches carried out in present have not proved a preferential repartition of sulphur content on size classes, and for this reason cannot be performed complete desulphuration by removing one technological coal size class with possible high sulphur content.

Variation of sulphur content, as it was presented in first part, depends on the ash content and, according our researches, on the density. Present technology afferent for removing the ash from the raw coal, do not provides for decreasing of sulphur content due to high percentage fine and coarse coal – classes –3mm and + 80 mm, for which, removal of pyrites is not proved, fact that is emphasizes by the low sulphur content of waste resulted from coal washing.

Sulphur is present in high percentage in the coal with low ash content, between 9 – 25 %, and further on it is noticed a trend of decreasing in the same time with increasing of ash content, according the results presented in diagram no.1 bellow.

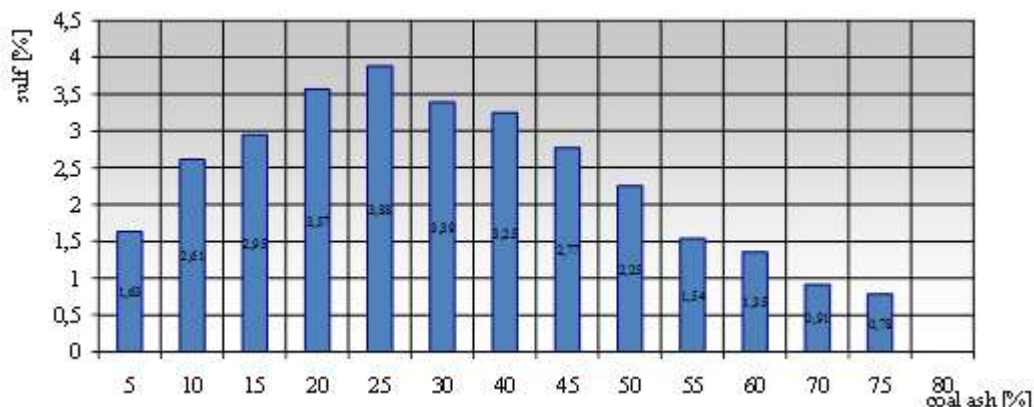

**Figure 1.** Evolution of sulphur content depending on the ash content

Mineralogical analyses proved that pyrite mineral mass is associated with combustible mass and as consequence of this fact, an advance size degradation preceding the concentration operations leads to possibility for mechanical removal of an important part of sulphur from hard coal. Despite the fact this procedure requires an additional energetically effort within the coal processing units, this will be reduced properly to coal consumers that have provided milling operation for preparing the fuel in order to be burnt in suspension.

Ecological briquetting or coal gasification operations represent also technologies that usually process graded and fine coals.

Partial removal of sulphur by processing of low size classes leads to major decreasing of ash content, and therefore to possibility for improvement of calorific power of processed coal products with positive effects for consumers both from thermal and ecological point of view.

This paper present few possible rehabilitation directions:[6],[5].

- mechanical desulphuration of graded and fine coal size classes, dosage and homogenization with coarse size products in order to deliver a hard coal with lower sulphur content;
- introduction in certain technological coal types of special sulphur inorganic acceptors and further on homogenization of delivered products;
- grading of middling and concentration of graded class by means of an adequate technology;
- production of ecological briquettes;
- coal gasification;
- study of possibilities for applying the carbolitic procedure to Jiu Valley hard coals.

Every of action directions presented above requires at least of minimal activity in the field of research and technological design in the same time with financial resources for purchasing or adjusting the equipments and existing installation to the new requirement.

### **3. PROPOSAL OF THE TECHNOLOGICAL SCHEME IN ORDER TO REDUCE THE SULFUR CONTENT CERTAIN FINAL PRODUCTS**

Coal Processing Plants produces certain technological and sellable products, some of them may have lower sulphur content when certain results already obtained in research are applied.

The low content of sulphur (aprox. 1.5 %) within the densimetrical class - 1.3 kg/dm<sup>3</sup>, as well as within the classes 1.75 – 1.95 kg/dm<sup>3</sup>, in comparison to the other intermediary densimetrical classes (over 3 %) offers the possibility for these densimetrical classes to be separated and to be dosed in the final products according to consumers' requirement.

The percentage of densimetrical class – 1.3 kg/dm<sup>3</sup> into the raw coal feeding the plant, is about 20 %; into the thermal processed hard coal is 60 %, and into the middling is of 18 %. The average ash content is of 4.5 % for densimetrical class



resulted from samples collected from raw coal, and of 5.5 % for thermal processed hard coal, and respectively of 6.4 % for middling.

In the case when this densimetrical class is graded and it is performed the gravitational sulphur separation, for example by means of concentrators type Knelson, or flotation, the sulphur content can be reduced below 0.5 %. Extraction in useful mineral (pyrite) it is estimated of about 73 %, product that can represent the object of a possible capitalization in the same fields where the pyrite concentrate is used as for complex ores.

The product that is mechanically desulphured and having a low ash content may represent a sellable product to a price covering the costs or to be dosed into the common products delivers to present consumers.

Actual processing flow sheet produces concentration of special coal to an ash content between 8.6 – 12 % that correspond to a separation density for the light product of 1.39 – 1.45 kg/dm<sup>3</sup>. In order to obtain a new product having above mentioned qualitative characteristics it is necessary to adjust the equipments used for separating the light products to a separation density bellow 1.3 kg/dm<sup>3</sup>.

This will change the quantities of intermediary products – middling, and heavy products – waste, which requires the adequate adjustment of separation, dewatering and transportation circuits. In the case when entire quantity of coal is washed (separated) to a density of – 1.3 kg/dm<sup>3</sup>, this means that it can be considered a theoretical recovery of aprox. 20 %.

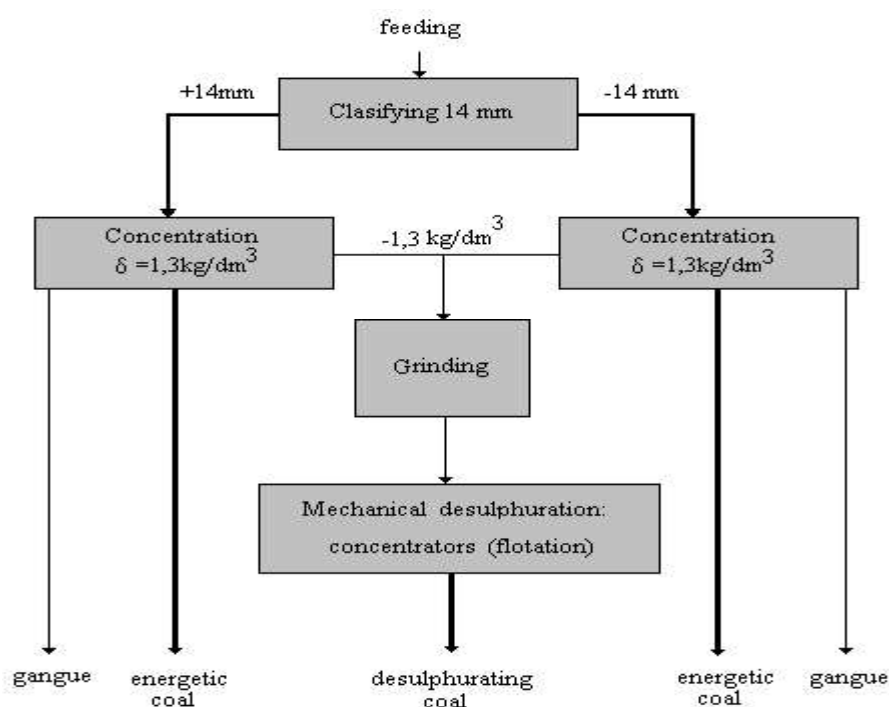

Figure 2. Proposal of the technological scheme

More advance removal of sulphur from an average of 1.5 – 1.8 %, by applying certain gravitational methods coal flotation up to 0.5 %, involves provision into the technological flow sheet of a grading installation that is properly located in order to provide the feeding of equipment for concentration of pyrite (centrifugal concentrator, flotation cells, e.t.c.). After this stage, technological coal class that was desulphurated can follow the present dewatering and storage circuit afferent for the special coal.

In the table bellow we present the main parameters and technological indexes estimated for the proposed variant.

**Table 1.** The main parameters and technological indexes estimated

<b>Product</b>	<b>Ash content (%)</b>	<b>Sulphur content (%)</b>	<b>Recovery of process coal (%)</b>	<b>Extraction of pyrite minerals(%)</b>
Raw coal feeding the plant	47	1.5 – 1.8	-	-
Class – 1.3 kg/dm <sup>3</sup>	5,6	>0.5	22	73.8 – 75,9

We estimate that presented variant involves minimum investment and offers the possibility for development in future stages, as for example by means of separation densimetrical class 1.75 – 1.95 kg/dm<sup>3</sup>, grading and concentration onto the circuit of class – 1.3 kg/dm<sup>3</sup> or of present circuit used for producing the special coal .

Economical and ecological effects are significant and these should be estimated globally in considering the mining activity, processing and preparing for burning, respectively the impact to the environment of products resulted after burning the coal: gases, powders, flying ash. In this case it can be noticed that size degradation of middling within the coal processing plants together with all increase of energy consumption will consider a major advantage for power station due to adequate decrease of grading and milling cost, of improved calorific power by removing the waste in the same time with sulphur minerals and reducing of load onto electro – filters used for retaining the fines from burnt gases and of the volume of stored flying ashes.

The superior calorific power resulting after processing the raw coal with the proposed technology, as well as sulphur content between the reasonable limits will justify fully a selling price covering all additional costs that has to be done in order to adjust the present flow sheet to new requirement and these can be covered from decreasing of environment damages.

Cancellation of delivering graded coal and integral processing of this coal in the view of obtaining sellable products, comparable to those on world market will lead by means of positive effects to improvement of quality against price, and to bringing the mining – processing activity to efficiency limit that in present is very much exceeded.

For the variant including sulphur inorganic acceptors we consider that no major problems is involved into the technological flow sheet, but the aspects regarding the most efficient substance, the most adequate size class and the effect to calorific power of sold hard coal should be settled.

The studies performed in present have lead to conclusion that from technological point of view it is less expensive and simple the variant involving

removal or neutralization of sulphur effect before coal burning and after. The major problems are generated by the necessity for additional actions in regarding the products resulted after burning, respectively hot gases and flying ashes.

Introduction into the processed coal of a desuplhuring agent in percentage adequate for neutralizing SO<sub>2</sub> during the burning process, and reduction of the quantity exhausted into the atmosphere should be correlated to the quantity of equivalent waste removed by processing, in the way that the influence to calorific power to comply the acceptable limits.

#### 4. CONCLUSIONS

Adjustment of coal processing technological flow sheet for mechanical reduction of sulphur content that is present into the raw coal has consequences that can be preseted as follows:

- percentage of graded and fine coal in technological products increases considerably as well as in the waste and sellable products;
- additional problems regarding the water treatment occurs;
- increases the consumption of energy and generally the processing costs regarding grading operations, separation in centrifugal concentrators or flotation, dewatering, water treatment and waste storage operation, etc.;
- ash content of processed products is reduced and in conclusion increases the calorific power of final products delivered to consumers to an adequate price;
- it occur the opportunity for capitalizing the size classes that is favorable for briquetting in order to obtain ecological fuel for industrial or household purposes;
- coal waste slime represents a secondary resource that can be also sold better than flying ashes consisting in mineral components artificially created.

Carbolitic technology represents a relatively cold process – maximum temperature is 90<sup>0</sup> C; it is required a proper homogenization and a good control of moisture content, of raw material distribution, of binder and additives. Dry elements are pre – mixed by means of an intensive mixing with additional water, which consist in first stage of process .

After mixing, the briquettes are incorporated into a coarse material in order not to be stuck between them, and of which screening and recirculating the material can separate them. Carbolitic briquettes have sizes of 3 – 80 mm.

We estimate that to our conditions there can be obtained sellable products with calorific power between 3500 – 4500 kcal/kg or even above 5000 kcal/kg in the case when working formula is settled in this aim.

#### 5. REFERENCES

- [1]. Gâf Deac – Tehnologii de ardere curată, Revista Minelor, nr.10-11/1999;
- [2]. Irimie I. S., Petrelean D. C., Environmental Impact Assessment for Dismantling an Energetic Complex Using Thermodynamic Concepts, "International Conference on ENERGY, ENVIRONMENT, ECOSYSTEMS and SUSTAINABLE DEVELOPMENT" (EEESD '13), Lemesos, Cyprus, March 21-23, ISBN: 978-1-61804-167-8, pp.76-81, 2013;

- [3]. Zaporojan E.- Cercetări privind determinarea conținutului de sulf din cărbunii de Valea Jiului și măsuri tehnologice de reducere a acestuia , Contract ICPM/RAM , 1994;
- [4]. Haneș N.- Contribution regarding the desulphuration of pitcoal produced in the Jiu Valley, 4th Conference on Environmental and Mineral Processing , Ostrava, 1998.
- [5]. Haneș N.- Tehnologii ecologice pentru reducerea impactului proceselor de extracție și preparare a cărbunelui din Valea Jiului asupra apelor, solului și aerului, Buletinul AGIR nr. 3/2006
- [6]. Bădulescu C.- Tehnici si tehnologii de procesare a resurselor minerale, Ed.Universitas, Petrosani, 2017.
- [7]. Petrilean D. C,Irimie S. I., Băleanu V., Stănilă S. - Multicriterial analysis of environmental impacts in thermoelectric power station areas, Environmental Engineering and Management Journal. June 2014, Vol.13, No. 6, 1383-1388;
- [8]. Pasculescu V.M., Suvar M., Pasculescu D. The necessity of implementing modern protection systems into the National Energetic System, Scientific Bulletin of the "POLITEHNICA" University of Timișoara. Vol. 56(70), Special ISSUE S1, 2011,pag. 55-58, Editura POLITEHNICA, ISSN 1224 – 6077.

## THE CIRCULAR ECONOMY AND THE STERILE SLUDGE FROM COROIEȘTI

Ciolea Daniela Ionela<sup>1</sup>, Bădulescu Camelia<sup>2</sup>, Berca Marius<sup>3</sup>

**Abstract:** *The development of a circular economy is an imperative for today's society. And the widespread application of sustainable methods, such as "upcycling, recycling, downcycling" would contribute to the development of an environmentally friendly industry. The circular economy is a key component in protecting the environment. In practice, the circular economy involves minimizing waste. When a product reaches the end of its life, the materials from which it is made are kept in the economy whenever possible. They can be used over and over again, creating added value. The transition to a circular economy will be systemic, profound and transformative, both inside and outside the EU. Sometimes this transition will be destabilizing, so it needs to be fair. This will require the alignment and cooperation of all stakeholders at all levels - European, national, regional, local and international. This paper presents the petrographic composition of the sterile sludge from U.P. Coroiești, which highlighted a significant share of vitrinite and clay minerals. Elementary analyzes indicate that this residue has a calorific value between 2110 and 2180 kcal / kg, which may be an advantage in advancing the idea of capitalizing on these ponds. Recultivation or biological arrangement is one of the main solutions for rendering in the economic circuit the land surfaces degraded by mining.*

**Keywords:** *circular economy, waste, resources, sterile sludge, biomass*

### 1. INTRODUCTION

The consumer society that emerged at the end of the twentieth century, along with the growing trend of the world's population, the intensification of the urbanization process, the development and diffusion of information and communication technology, the continuous increase of the standard of living, the reduction of the product life cycle. have contributed to increasing the volume and diversification of waste streams. [6]

Given the sharp decline in natural resources, the rapid deterioration of air, water, soil quality and the deterioration of natural ecosystems, international concerns about waste management have become dynamic in identifying the best solutions and technologies. In this context, waste management has become a fundamental issue of future socio-economic evolution, a direct result of a present linear economic development.

There is now a general consensus that sustainable economic and social development requires proper management of raw materials, waste, by-products, energy,

---

<sup>1</sup> Assoc. Prof. Eng. Ph.D., University of Petrosani

<sup>2</sup> Assoc. Prof. Eng. Ph.D., University of Petrosani

<sup>3</sup> Eng. Ph.D.

and so on. enabling the conservation of the planet's limited natural resources and the protection of the environment.

The transition to a circular economy, in which the value of products, materials and resources is kept in the economy for as long as possible and the production of waste is kept to a minimum, has gained special attention, being on the agenda of public authorities, business, research institutes and non-governmental organizations. Lately, the concept of circular economy has experienced an exponential development through the active involvement of all stakeholders. [6]

Valuable materials are used in food preparation, in the construction of infrastructure and buildings, in the production of consumer goods or in the supply of energy - in fact, everywhere. Once they are consumed or no longer needed, they are disposed of as waste. However, due to population growth and wealth, the demand for limited resources is higher than ever and leads to environmental degradation. Now is the time to take care of those resources and equip the business with the right tools to join the circular economy model.

Thus, in the literature there are several definitions of the circular economy, centered around key concepts such as: sustainable development, the 4R (Reduction, Reuse, Recycling, Recovery).

The definition of the circular economy proposed by the European Commission: *“in a circular economy, the value of products and materials is maintained as much as possible; waste and resource use are kept to a minimum, and when a product reaches the end of its life, it is used again to create added value; this can bring major economic benefits, contributing to innovation, growth and job creation”*. [6]

The circular economy promotes an ecological philosophy such as *"Nothing is lost, everything is transformed"* or *"One's garbage is another's treasure"*. [4, 5]

## **2. THE TRANSITION FROM THE LINEAR ECONOMY TO THE CIRCULAR ECONOMY**

We can best understand the concept of the circular economy if we look at natural, living systems that work optimally because each piece of them is part of the whole. The products are intentionally designed to fit into a particular cycle of materials, and these materials have a flow that keeps them of added value for as long as possible and reduces residual waste to almost zero.

The circular economy is a system based on reduction, reuse and recycling because waste is considered a valuable resource. Used or defective products can be repaired and reused, other products can be reused directly, and others can be recycled.

As the name suggests, this type of economy requires a continuous system of production and reuse of resources and waste that can be used in many fields, from the fashionable food industry to the automotive and energy industries. There are already initiatives in this regard, albeit only on a small or medium scale.

The circular economy has become an extremely popular term in recent years. It is seen as a solution to the global environmental crisis that is affecting the whole world and is as severe as the pandemic, although perhaps less obvious.

The implementation of the circular economy will implicitly lead to [4, 6]:

- ✓ reducing the amount of waste generated;
- ✓ increasing the productivity of the resources used;
- ✓ considering waste as a valuable product;
- ✓ encouraging the recycling of valuable materials;
- ✓ reducing the destructive impact that production and consumption processes have on the environment.

The transition to a circular economy promotes sustainable production and consumption patterns that can be implemented in a society in constant search of new sources for self-sustaining economic growth. The process of transforming the classical-linear model into a circular one involves reconsidering unsustainable aspects in order to identify future development opportunities.

The notion of circular economy represents a new, emerging perspective on sustainable development. The roots of this perspective lie in the biosphere, where anything can become a resource for the next level of the food chain, in order to eliminate waste. [6]

The notion of circular economy also calls into question the current linear model, based on production and consumption. The linear model comprises the following four steps:

- ✓ take from nature;
- ✓ make a product;
- ✓ use the product;
- ✓ dispose of waste, which often results in pollution of resources.

This model has created an economy that depends heavily on the use of energy and other resources to produce and deliver products and services, which leads to the degradation of the natural environment, of which we are part and on which we depend to meet our needs. everyday.

Also part of this model is wear programming - designing a product to have a limited lifespan to encourage consumers to buy a new one. The European Parliament has called for measures to combat this practice.

The purpose of the circular economy is to break the classic cycle of raw materials - processing - consumption - waste. Specifically, it aims to take the waste and put it back into production. Thus, the cycle looks something like this: raw materials - processing - consumption - reuse of waste in production. And then the process starts from scratch.

The circular economy involves more than waste management, it brings to the fore the idea of closing the loops of resource consumption whenever it is technically feasible. [4]

### **3. GREEN ECONOMY**

A concept interconnected with the circular economy is the one referring to the green economy, which proposes, through the conceptual definition, a direct reference to "improving social welfare and equity, while significantly reducing environmental risks and ecological deficit".

The concept of the "green economy" has been hotly debated lately because it is considered essential for the future of the world economy. This concept aims to find

concrete solutions with applicability in the international issue of environmental development as a result of the massive problems generated by the multiple crises that can no longer be solved.

From this perspective, the transition to a green economy can be interpreted from several angles, namely:

- efficient use of resources by implementing innovative approaches to optimize resource consumption and minimize greenhouse gas and waste emissions.

- a sustainable approach to resources to ensure the preservation of natural capital, the resilience of ecosystems, and ensuring social inclusion.

Issues that are interconnected with the approach proposed by the circular economy relate, in particular, to waste management, the promotion of resource efficiency and, implicitly, the achievement of a higher degree of social welfare.

The perspectives offered by the green and circular economy reinforce the broader approach to sustainable development as a whole, with the common denominator of environmental protection, increasing the competitiveness and productivity of the resources available in an economy.

The transition to a green economy is a medium- and long-term process that involves a political commitment on the part of states that want a change in the pattern of economic development. In this sense, the characteristics of this process are a series of various initiatives, namely:

- raising public awareness of the implementation of a green approach in national policies (renewable energy, energy efficient buildings, low GHG technologies and processes);

- promoting new indicators that complement the GDP (steps towards the implementation of the green GDP, the ecological footprint);

- development of green investment markets (eg banking and green investment services).

Given that half of total greenhouse gas emissions and over 90% of biodiversity loss and water stress are caused by resource extraction and processing, the European Green Pact has launched a concerted strategy for a neutral economy in terms of climate impact, resource efficient and competitive. Extending the circular economy from pioneers to major economic actors will make a decisive contribution to achieving climate neutrality by 2050 and decoupling resource growth from resource use, while ensuring the EU's long-term competitiveness and the fact that no one is left behind.

To achieve this ambitious goal, the EU must accelerate the transition to a model of regenerative growth, giving back to the planet more than it takes, moving towards a situation in which it keeps its consumption of resources within the limits of the planet, and therefore, to strive to reduce its consumption footprint and double its rate of circular use of materials over the next decade.

For businesses, working together to create a framework for sustainable products will provide new opportunities in the EU and beyond. This gradual but irreversible transition to a sustainable economic system is an indispensable component of the EU's new industrial strategy. A recent study estimates that applying the principles of the circular economy to the EU economy as a whole has the potential to increase EU GDP by 0.5% by 2030, creating around 700.000 new jobs. There are also clear economic



arguments for individual companies: given that EU manufacturing companies spend, on average, around 40% on materials, closed-loop materials management models can increase their profitability, while protecting them from resource price fluctuations.

Europe will not achieve radical change if it acts alone. The EU will continue to play a leading role in the transition to a global circular economy and use its influence, expertise and financial resources to implement the 2030 Sustainable Development Goals. [4]

#### **4. DESIGNING SUSTAINABLE PRODUCTS AND CREATING A FUNCTIONAL EU MARKET FOR SECONDARY RAW MATERIALS**

Up to 80% of products' environmental impacts are determined in the design phase, but the "take-produce-use-throw-away" linear model does not provide producers with sufficient incentives to ensure greater circularity for their products. Many products break down too quickly and cannot be easily reused, repaired or recycled, and many are made to be used only once. However, the single market provides a critical mass that allows the EU to set global standards for product sustainability and to influence product design and global value chain management.

As part of this legislative initiative and, where appropriate, through complementary legislative proposals, the Commission will consider establishing sustainability principles and other appropriate ways to address the following issues:

- ✓ improving the sustainability of products and the potential for reuse, updating and repair, controlling the presence of hazardous chemicals in products and increasing the efficiency of products in terms of energy consumption and resource use;
- ✓ increasing the content of recycled materials in products, while ensuring their performance and safety;
- ✓ ensuring that products can be remanufactured and recycled at a high quality level;
- ✓ reducing the carbon footprint and the environmental footprint;
- ✓ restricting disposable products and combating premature obsolescence;
- ✓ the introduction of a ban on the destruction of durable goods that have not been sold;
- ✓ stimulating "product-as-a-service" business models or other models in which manufacturers retain ownership of the product or are responsible for its operation throughout the entire product life cycle;
- ✓ mobilizing the potential for digitization of product information, including solutions such as passports, labels and digital watermarks;
- ✓ rewarding products based on their sustainability performance, including providing incentives for high levels of performance.

It is difficult for secondary raw materials to compete with primary raw materials, for reasons that are related not only to safety but also to performance, availability and costs. A number of actions envisaged in this plan, in particular the introduction of requirements on the content of recycled material in products, will help to prevent an imbalance between the demand and supply of secondary raw materials and ensure the

gradual development of the recycling sector in the EU. In addition, in order to create a functioning internal market for secondary raw materials, the Commission [4]:

- ✓ assess the possibility of developing additional criteria for determining the cessation of waste status at EU level for certain waste streams, based on monitoring the application by Member States of the revised rules on the cessation of waste status and by-products, and support cross-border cooperation initiatives to harmonize national criteria for the cessation of waste status and those for by-products;
- ✓ strengthen the role of standardization on the basis of a continuous assessment of existing standardization activities at national, European and international level;
- ✓ make timely use of restrictions on the use of substances of very high concern in cases where the use of those substances is subject to an authorization requirement, while continuing to improve border controls, and
- ✓ assess the feasibility of setting up an observatory of the market for essential secondary raw materials.

## **5. DESCRIPTION OF THE COROIȘTI SETTLEMENT PONDS**

The ponds are located in the meadow on the right bank of the West Jiul River, downstream of the preparation plant. In this area, the flow direction of the West Jiu River is V-E, the meadow having a slope of 7% along the river and 18% on the N-S direction, towards the riverbed.

The location of the tailings ponds is crossed by the Mohora brook, which flows into the West Jiul, the last part of the course being located between the SE dam of compartment I B and the western dam of pond II. The rainwater flow is  $376 \text{ l/s} \cdot \text{ha}$ .

The basic geological formation on which the tailings ponds were formed consists of deposits of the Oligocene age represented by clayey rocks and sandstone rocks. Recent deluvial and quaternary deposits are found over the basic formation.

The alluvial bed of the West Jiu meadow has a thickness of 3-4 m in this area, being made up of gravels and boulders, in a mass of medium and fine sand, over which lenticular clay-sand deposits develop lenticularly.

From the petrographic point of view, the productive horizon consists of an alternation of gray clays, sometimes black, gray or bituminous marls, marl-limestone and fine cemented sandstones.

The basal horizon is characterized by an alternation of thick layers of clays and sandstones, subordinated by breccias and microconglomerates.

At the Coroiști preparation plant, due to the low inclination of the site, the solution was adopted to build some "field" type ponds by damming some surfaces that amount to approximately 25 hectares.

The perimeter dams were made of local material excavated from the dam of future tailings dumps, with a trapezoidal cross section.

The tailings pond no. I, put into operation in 1964, consists of two compartments A and B and is located in the meadow to the right of the western Jiu, downstream of the preparation plant and occupies a total area of 14 ha. The elevation of the beach level in

compartment I A is 601.5 m and in compartment IB 597.5 m. Currently the amount of tailings stored in pond I is approx. 3.300.000 tons.

Compartment A is made by closing with perimeter dams, whose heights from the natural terrain are between 7.1 and 12.6 m on the west side, increasing in the S-N direction between 14.60 m on the north side. The slopes of the slopes are 27° on the western dam, 28° on the southern one and 32° on the northern one.

At compartment B of pond I, the heights of the dams are between 7.1 m and 13.5 m on the southern side, towards the Mohora brook, increasing in the S-N direction. The slopes of the contour dams are 30-31° on the south side and 28-31° on the north side.

The tailings pond II occupies an area of 10.8 ha, the dams have a trapezoidal cross section, with an average height of 2.7 m, a crown width of 3.5 m, an inclination of the outer slope of 33°. The amount of sterile sludge stored in this pond is about 2.000.000 tons. This pond came into operation in 1968. [2, 4]

In accordance with the methodology for establishing the importance categories of dams - TNLH 021, the tailings ponds from Coroești fall into the category of importance B - dam of special importance, as a result of the value of the associated risk index, which is determined by the relationship (1):

$$RD = \frac{CA}{BA + CB} \quad (1)$$

where:

CA = 25 - consequences of deposit damage;

BA = 54 - characteristics of the deposits and conditions of the site;

CB = deposit status.

The classification in the importance classes was established on the basis of the technical analysis, taking into account:

- the consequences of a possible damage for the neighboring areas;
- the degree of confidence of the basic data used in the design of the ponds;
- information on the behavior over time of tailings ponds. [2]

## 6. SAMPLING AND CHARACTERISTICS OF THE STERILE COROIEȘTI SLAM

Sampling was performed on the surface of the two tailings ponds I A, IB and II. The 10 boreholes were drilled to a depth of 3 m, taking samples from meter to meter. The ash of the sterile sludge, on the drilling depth, is shown in Table 1. [2, 4]

**Table 1.** Ash contents on drilling depth

Nr. sample	Drilling depth (m)		
	1 m	2 m	3 m
IA-1	53.55	54.20	39.99
IA-2	66.50	58.50	56.08
IA-3	54.18	57.70	47.51
IA-4	74.61	57.98	28.37
IA-5	23.31	27.47	44.01

IA-6	40.06	46.72	58.36
IA-7	69.79	67.40	53.44
IB-1	78.40	77.65	82.85
IB-2	78.65	78.25	66.95
II -1	69.22	80.02	75.68

Table 2 shows the petrographic composition of the sterile sludge from U.P. Coroești, which highlighted a significant share of vitrinite and clay minerals. [2, 4]

**Table 2.** The petrographic composition of the sterile sludge from U.P. Coroești

Petrographic component name	Content (%)
Showcase with 5% free	40.23
Clay minerals	43.21
Iron minerals	16.89
Iron carbonates	0.56
Pyrites	0.85

Table 3 shows the physico-chemical parameters of the sterile sludge from U.P. Coroiesti [2, 4].

**Table 3.** Elementary analyzes of sterile sludge

Parameter	U.M.	Determined value
Volatile matter	%	14.40
Higher calorific value	kcal/kg	2180
Lower calorific value	kcal/kg	2110
Carbon	%	21.13
Hydrogen	%	1.5
Sulfur	%	0.62
Azote	%	0.32
Oxygen	%	3.30

The elementary analyzes performed showed that this residue has a calorific value between 2110 and 2180 kcal / kg, which can be an advantage in advancing the idea of capitalizing on these ponds. [2]

Recultivation or biological arrangement is one of the main solutions for rendering in the economic circuit of degraded land surfaces during mining. [3]

### 3. THE EXPERIMENTAL PART

After taking the Coroiesti sterile sludge samples, in November-December 2021, the following five recipes were designed and verified (Figure 1) [1, 4]:

- R1 - 100% sterile slurry composition Coroiesti;
- R2 - composition 75% sterile sludge Coroiesti and 25% soil;
- R3 - composition 50% sterile sludge Coroiesti and 50% soil;
- R4 - composition 25% sterile sludge Coroiesti and 75% soil;
- R5 - composition 100% soil.



**Figure 1.** Vegetation pots (Coroiesti sterile sludge - fertile soil) according to R1-R5 recipes and plant evolution

The experimental level was followed (Figure 2) [4]:

- ✓ localization of water absorption at the root level;
- ✓ the circulation of raw sap at the level of the stem, leaves and flowers;
- ✓ highlighting aerobic respiration after oxygen consumption;
- ✓ highlighting the aerobic breath after the carbon dioxide produced;
- ✓ highlighting the phenomenon of perspiration in plants;
- ✓ highlighting the morphological phenomena of plant germination;
- ✓ highlighting the types of germination;
- ✓ determination of the faculty and germinal energy of the seeds;



**Figure 2.** Sequences in measuring pH, temperature, brightness and other indicators (in 2021)

- ✓ location of root growth areas.
- ✓ highlighting plant movements (geotropism, phototropism and hydrotropism). [4]

## 8. CONCLUSIONS

The implementation of the circular economy will implicitly lead to:

- ✓ reducing the amount of waste generated;
- ✓ increasing the productivity of the resources used;
- ✓ considering waste as a valuable product;

- ✓ encouraging the recycling of valuable materials;
- ✓ reducing the destructive impact that production and consumption processes have on the environment.

The re-fertilization of degraded lands following the extraction of useful mineral substance and sterile rocks is difficult and must be analyzed as a whole from one climatic and pedological zone to another, in order to determine the possibilities of adapting various plant species and varieties to recultivation. and the steps to be taken to improve these lands.

Biological recultivation or re-fertilization of sterile material, involves laboratory studies consisting of physical-mechanical analyzes on the lands to be re-fertilized, regarding granulometry, acidity, permeability, pH, sulfur, phosphorus, calcium and humus content, experiments in vegetation vessels or in the field, where various species of plants are cultivated, using the material from the improved and unimproved pond and on which a series of phenological observations are made such as: date of emergence of plants, number of mature plants, length of plants at maturity, delays in ripening and the attack of various diseases.

Green manure cultivation is an ecological means of fertilizing and protecting the soil. Green manures are special crops, which are incorporated into the soil to reach a maximum of dry matter accumulated in the vegetative parts, often in the flowering phase, to improve the soil. In addition, these crops have the role of protecting its surface, which, in the intervals between two crops, remains uncovered by the carpet and is exposed to climatic factors, especially weather (eg torrential rains with speeds exceeding the speed of soil infiltration and which cause runoff) and wind (wind erosion, especially in less structured soils).

The essential role of organic matter in defining soil fertility and plant production capacity has gained new production under the conditions of intensifying agriculture in our country. Organic matter stores in its constituents chemical energy and biogenic elements, which release them into the soil in small quantities and continuously, during the transformations under the influence of the activity of microorganisms.

#### **4. REFERENCES**

- [1]. Ciolea, Daniela Ionela, Ionel Ioana, Mihaiuti A. (2019) - Research Concerning the Possibility of Turning Sterile Soil Into a Fruitful One, by Using Sludge, pp. 3236-3241, *Revista de Chimie*, București, 70, No. 9, <https://www.revistadechimie.ro/pdf/32%20CIOLEA%209%2019.pdf>,
- [2]. Bădulescu Camelia (2021) - *Procesarea diferitelor tipuri de deșeuri industriale*, Editura Universitas, ISBN 978-973-741-746-6, Petroșani
- [3]. Dunca Emilia, Biro Carol (2006) - *Pedologie, îndrumator de laborator*, ISBN 973-741-33-5, Editura Universitas, Petroșani
- [4]. \*\*\* Contractul de cercetare universitară nr. 6445/07.10.2021 - Cercetare științifică universitară privind ecologia și protecția mediului în economia circulară, Universitatea din Petroșani, 2021
- [5]. <https://wasteix.ro/2020/07/22/protejarea-mediului-inconjurator-si-economia-circulara/>
- [6]. [http://ier.gov.ro/wp-content/uploads/2019/03/Final\\_Studiul-3\\_Spos-2018\\_Economie-circular%C4%83-1.pdf](http://ier.gov.ro/wp-content/uploads/2019/03/Final_Studiul-3_Spos-2018_Economie-circular%C4%83-1.pdf)

## USE OF INDUSTRIAL WASTE IN THE CONTEXT OF THE CIRCULAR ECONOMY CASE STUDY - POWER PLANT ASHES

Bădulescu Camelia <sup>1</sup>

**Abstract:** *The paper presents the researches undertaken for the superior capitalization, in the context of the circular economy, of the power plant ashes and other industrial wastes, in the construction materials industry. Taking into account the specific properties of the ash from the thermal power plant, a technological scheme was elaborated through which the recovery of iron oxides was pursued (their share being significant). Due to the hydraulic properties of power plant ash, similar to those of classical construction materials, laboratory research was conducted in order to develop a material usable in the construction materials industry with superior characteristics.*

**Keywords:** *industrial waste, ash, bricks*

### 1. INTRODUCTION

The ashes and the breezes from the fossil combustible burning in thermoelectric plants are situated in the category of industrial hazardous wastes, which can be stock-piled in non-hazardous waste deposits.

These, due to their volume and multiple utilization possibilities represent the most important industrial wastes with high economic and ecological implications. The recovery of these wastes is a major concernment imposed by a series of factors:

- the limitation of the natural resources of utile minerals;
- environmental protection;
- the possibility of capitalizing on this industrial waste;
- the limited functioning of the ash ponds.

### 2. METHOD AND MATERIALS

#### 2.1. *The properties of fly ashes*

The research was based on the ash and breeze ponds from the two thermoelectric coal plants in Hunedoara county: SC Electrocentrale SA Mintia and SC Termoelectrica SA-SE Paroşeni which cover an approximate 250 ha area and can store more 30 million tones of waste [15].

---

<sup>1</sup> *Assoc.Prof.Ph.D.Eng. University of Petrosani, E-mail: badulescu\_c@yahoo.com)*

According to the actual estimates, in the world, 30 % of the ash from the coal burning can be reutilized. From that, approximate 40% is used to produce concrete and 4% for the asphalt filling. [3], [5]. [6], [7].

In our country, the utilized percent of these industrial wastes is approximate 1%.

The utilization domains of the thermoelectric plant ashes, in our country are: in the construction materials industry like an addition to the cement production; in concrete processing and in the manufacturing of light aggregates like granulites; in road construction; for soil amendments; like backfill material.

Such type of research has been made since 1954 on ashes from CET Paroşeni and CET Doiceşti [4], [12],[13], [14].

All of these domains for the utilization of this industrial waste take no account of physical chemical and mineralogical specific properties of this waste and the potential infestation of the phreatic water with heavy metals from these wastes.

The most common usage of these ashes is like a substitute in cement and concrete, that being a good thing in the actual context when, in order to reduce the pollution (the cement factories are responsible for 6% of the carbon dioxide emissions), appears the necessity of finding eco-friendly materials. In this sense, in France, there was created a “geopolimer” that contains silica and alumina, the macroelements that are in a high percentage in thermoelectric plants ashes. These geopolimers obtained from the ashes, have the carbon emissions almost zero because they don't need preliminary calcination, and the final price decreases with 30% below that of the classic cement.

Regarding the recovery of the utile elements from thermoelectric plants' ashes, the researchers direct their efforts precisely on the recovery of iron oxides ( $\text{Fe}_2\text{O}_3$ ,  $\text{Fe}_3\text{O}_4$ ) in order to create ferrous concentrates, utile in the metallurgic industry [8], [9], [10].

### ***The ashes chemical composition***

The ashes resulting from the burning of coal from the Jiu Valley contain: Si, Al, Fe, Ca, Mg, S, Na, K, Ti, P [1] - considered macroelements and a series of chemical elements such as: Ag, Au, Pb, Be, As, Mo, Ge etc. considered as microelements because they have a content of less than 1.0%.

### ***The ashes mineralogical composition***

The ash pond from Paroşeni (Jiu Valley) and Mintia is a result of the superposition of two feeding sources, one inorganic and another of organic nature. The mineralogical composition of this ashes is: magnetite, bloodstone, sphene, pyrites calcite, dolomite, oxidized products of sulphates and carbonates of Pb, Zn, Cu, metakaolinite, kaolinite, chlorite

The physical analysis shows that the ashes deposit from Paroşeni looks as a compact powder, microporous spheres or compact glassy spheres; other characteristics



are: the grinding fineness is about 68% - 0.074 mm, low permeability and a high magnetic susceptibility [1].

In conclusion, starting from the physical-mechanical characteristics of the ashes we tried an integral and efficient capitalization in the construction materials domain.

### **3. RESULTS AND DISCUSSIONS**

#### ***3.1. Setting-up the technological scheme of the ash processing***

Taking into account the physical-chemical and mineralogical characteristics, the aim of ash processing is to obtain a heavy product, respectively a magnetic concentrate with a high grade of precious metals.

In figure 1 it is shown the technological scheme of the ash processing.

Three main products are obtained as a result of the ash recycling:

- a solid waste "B" for the construction materials industry (92.94% of ash mass, with 5.11% Fe);
- a radioactive nonmagnetic product "R"(1.14 % of the ash mass) with 0.016% U, which can be recovered; Any case, it must be relieved from the first component;
- a magnetic product "C" with precious metal content, 5.92 % of the ash mass, with 55.31 % of Fe. [1].

#### ***3.2. Research regarding the usage possibilities of the ashes in the construction materials industry***

The physical-chemical processes which determine the hydraulic capacity of the ashes is an important step in order to establish the optimal methods of the ashes' usage.

The hydraulic properties of the ashes are the result of the presence of two oxides categories: acidic oxides ( $\text{SiO}_2$ ,  $\text{Al}_2\text{O}_3$ ,  $\text{Fe}_2\text{O}_3$ ) and basic oxides ( $\text{CaO}$ ,  $\text{BaO}$ ,  $\text{Na}_2\text{CO}_3$ ,  $\text{Na}_2\text{SiO}_3$ ).

The basic salts used in the system ash-water, generate reactions with hydrated mineralogical compounds which assure the resistance structure development. The activation and the reinforcement process are encouraged also by the chemical, mineralogical composition and by the report between the vitrous and crystalline mass, etc.

The ashes, after a cooling process in fast thermodynamic conditions, have a strong acid character and a microstructure with a great vitrous weight (45-88%). The main crystalline components from the Jiu Valley ashes deposit are: mullite, quartz, hematite, magnetite and feldspars.

In the hydraulic reinforcement process, some mineralogical components are inert (mullite, quartz, magnetite) and another are active, determining the selfreinforcing reactions. The report between the vitrous and crystalline phases determines the value of hydraulic activity.

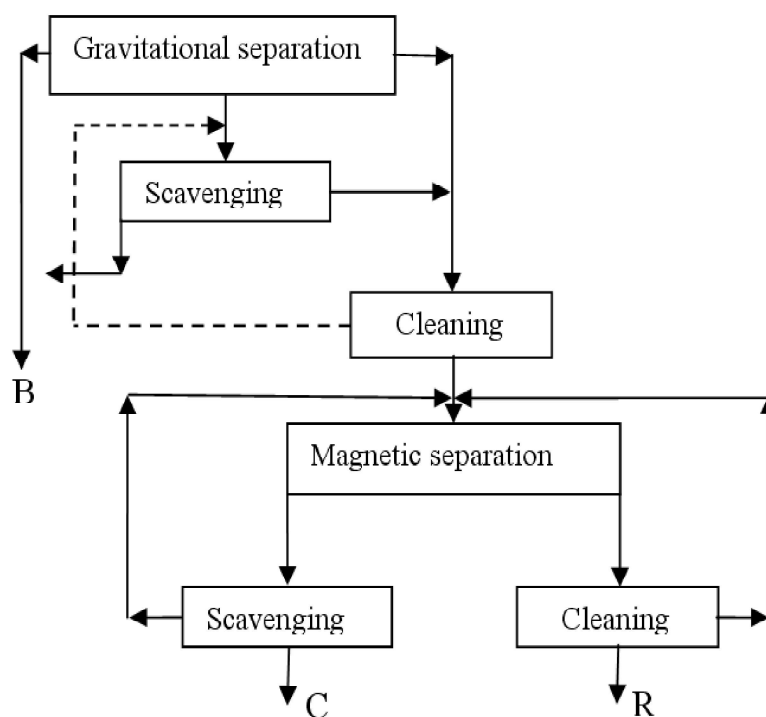

**Figure 1.** The processing of ash scheme [2]

Simultaneously with the cvasicrystalline structure forming, increases the number of structural faults, the disassociation degree and the polarity. These aspects conduct to the increasing of the ashes hydraulic activity.

The ashes from the Jiu Valley have very good reinforcement characteristics which could be increased by using some chemical substances called activators. The activators enhance the starting of some chemical reactions and physical processes which determine the obtaining of resistance structure and durability similar with the hydraulic binding materials. The best activator is the calcium oxide. This is indicated for his activity, first of all because it creates an optimum basic medium in the ash-water-activator system; and second, this medium is capable to release the chemical reactions which are the basis of the resistance structure. The kinetics of the physical-chemical process at calcium activating ashes depends of some influence parameters such as: the  $\text{SiO}_2 + \text{Al}_2\text{O}_3 + \text{Fe}_2\text{O}_3$  content, the specific surface, crystalline structure, carbon content, the  $\text{Ca}(\text{OH})_2$  quantity, etc. It was established that for the siliceous-aluminous ashes with the parameter  $\% \text{SiO}_2 + \% \text{Al}_2\text{O}_3 + \% \text{Fe}_2\text{O}_3 > 70$ , the activating is efficient.

Starting from these reasons, we made a lot of trials to the laboratory scale in order to obtain different types of BCFA (cellular concrete without autoclaving) bricks utilizing some industrial and domestic wastes (ashes from thermoelectric plants, expanded polystyrene, granules or ribbons of PETs). These trials are part of an invention patent [11].

In this paper we propose some recipes for light cellular concrete based on cement, thermoelectric plant ash, expanded polystyrene, ribbons of PETs, some mechanical foam and water to obtain a good consistency.

In figures 2, 3, 4, there is presented the influence of the ash quantity on the compression resistance (fig.2), porosity (fig.3), density (fig.4) and the variation of the porosity of BCfA with froth agent consumption (fig.5).

The qualitative obtained characteristics, as well as the thermic and phonoisolated properties, recommend the utilization of these products in special insulation works, these taking successfully the place of conventional BCfAs in construction works, due to their mechanical resistance. The trials regarding the mechanical resistance, porosity degree and density for different recipes of BCfA are presented in table no. 1 .

Using the proposed procedure there can be obtained some advantages:

- The utilization, in the process of manufacturing BCfAs, of some industrial and domestic wastes and the inert of those in a hydraulic matrix;
- Obtaining some products with characteristics comparable with those of the conventional products;
- The obtained products due to their characteristics can be used in thermic and phonic insulation works;
- Decreasing the manufacturing price, by replacing, partially the cement and sand with thermoelectrical plant ash and with other composite materials;
- Cellular concretes do not contain aluminum powder;
- The recycling of some non-biodegradable materials.

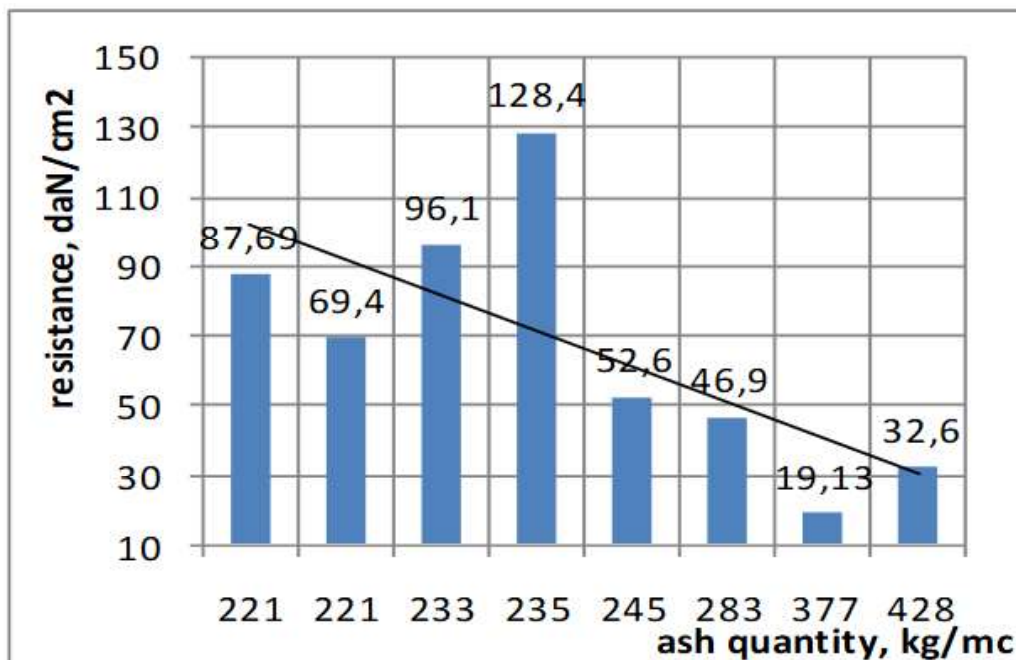

Figure 2. The variation of compression resistance of BCfA with ashes content

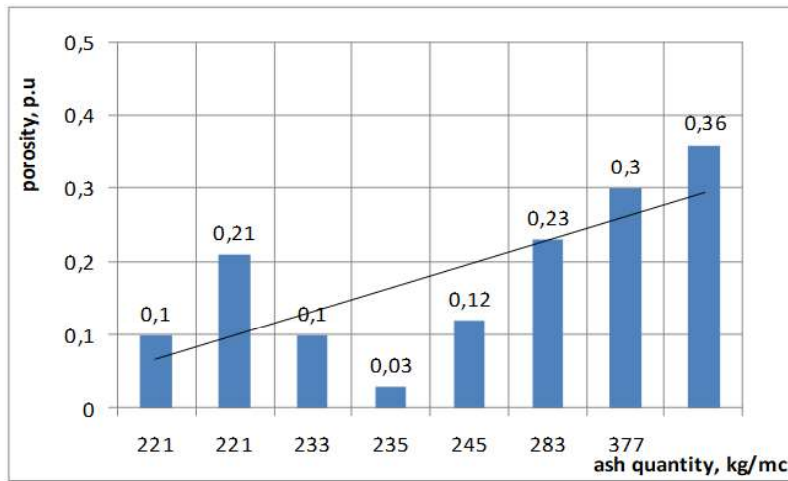

Figure 3. The variation of the porosity of BCfA with ashes content

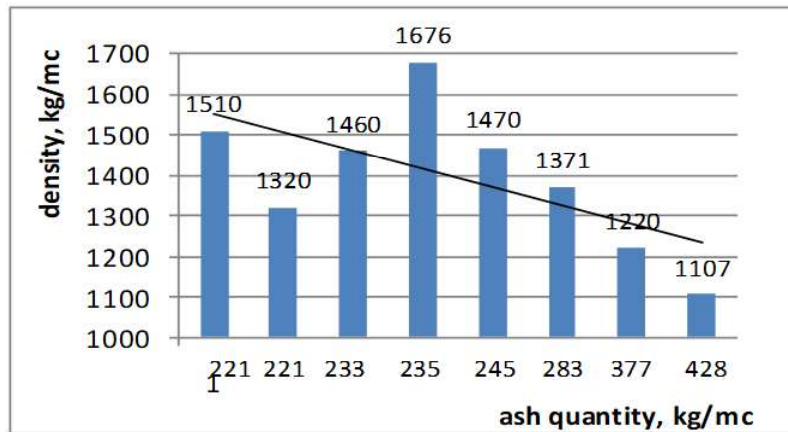

Figure 4. The variation of the density of BCfA with ashes content

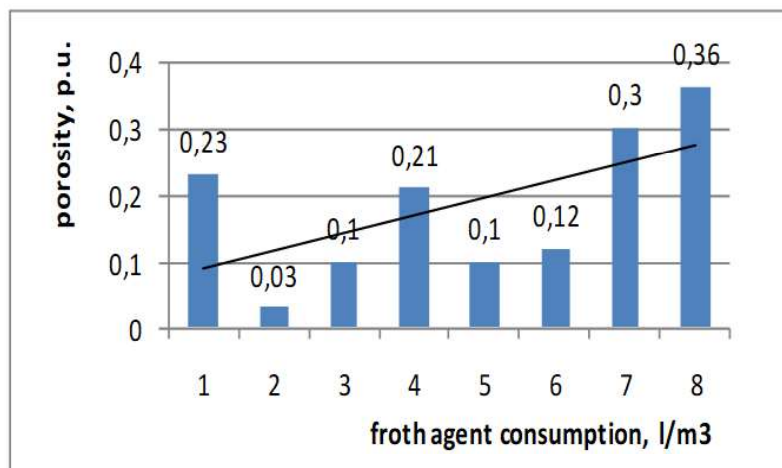
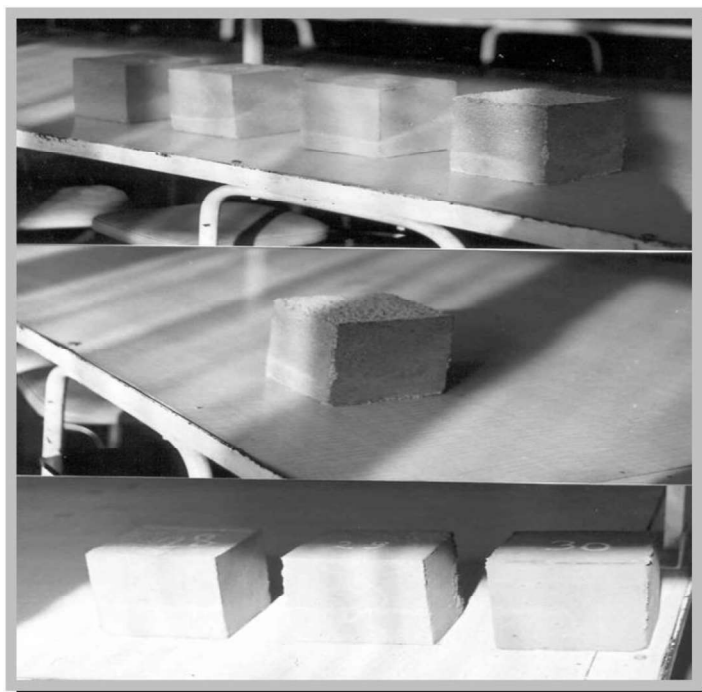

Figure 5. The variation of the porosity of BCfA with froth agent consumption

**Table 1.** BCfA recipes and their physical characteristics

Sample Composition	1	2	3	4	5	6	7	8
Sand – 0.3 mm, kg/m <sup>3</sup>	-	<b>353</b>	-	<b>332</b>	<b>350</b>	<b>209</b>	<b>214</b>	-
Cement Port.32.5	<b>121</b>	<b>348</b>	<b>125</b>	<b>332</b>	<b>350</b>	<b>104</b>	<b>285</b>	<b>223</b>
Ash, kg/m <sup>3</sup>	<b>242</b>	<b>235</b>	<b>378</b>	<b>233</b>	<b>233</b>	<b>377</b>	<b>428</b>	<b>312</b>
Lime, kg/m <sup>3</sup>	-		-	-				<b>45</b>
Polistirene kg/m <sup>3</sup>	-		<b>4,0</b>					<b>4,63</b>
Granulated PET, kg/m <sup>3</sup>	<b>33,4</b>		<b>8,5</b>					-
Froth agent, l/m <sup>3</sup>	<b>6,0</b>	<b>1.2</b>	<b>6,0</b>	<b>2.0</b>	<b>3.0</b>	<b>10.0</b>	<b>7.9</b>	<b>0,9</b>
Compression resistance, daN/cm <sup>2</sup>	<b>68</b>	<b>128.4</b>	<b>25.0</b>	<b>69.40</b>	<b>96.10</b>	<b>19.13</b>	<b>32.6</b>	<b>28</b>
Porosity, p.u.	<b>00,35</b>	<b>0.03</b>	<b>0.2</b>	<b>0.26</b>	<b>0.10</b>	<b>0.3</b>	<b>0.36</b>	<b>0,35</b>
Density, kg/m <sup>3</sup>	<b>950</b>	<b>1676</b>	<b>802</b>	<b>967</b>	<b>1460</b>	<b>1220</b>	<b>1107</b>	<b>950</b>

**Figure 6.** BCfA samples obtained in the laboratory

#### **4. CONCLUSIONS**

The present study emphasizes the utilization of some industrial waste – ashes from thermoelectric plants - polystyrene and PETs to create some cellular concrete, trying to obtain some particularities that may permit those to be used instead of conventional products.

- The specific properties of the ashes from the burning of Jiu Valley energetic coal permit the utilization of this kind of industrial wastes as a composite material for BCfA;
- The proposed recipes for cellular concrete had the purpose of obtaining some materials with qualitative characteristics comparable with those of conventional materials: compression resistance higher than 30daN/cm<sup>2</sup>, low porosity, reduced wrack density;
- Having special hydraulic properties the ashes from thermoelectric plants permit the substitution of lime and cement to a certain content - not higher than 40%;
- The implementation of the proposed process has some advantages:
- The utilization, in the process of manufacturing BCfA, of some industrial and domestic wastes and the inert of those in a hydraulic matrix;
- Obtaining some products with characteristics comparable with those of the conventional products;
- The obtained products due to their characteristics can be used in thermic and phonic insulation works;
- Decreasing the manufacturing price, by replacing, partially the cement and sand with thermoelectrical plant ash and with other composite;
- Protecting the environment by recycling some non-biodegradable.

#### **5. REFERENCES**

- [1].Badulescu,C, Traista, E 1998. Researches Regarding the Possibilities to Extract Utile Compounds from Thermoelectric Plant Ashes (Romanian), In: Revista Minelor, no.4, vol.85, pp.38;
- [2].Badulescu, C, Andras, I 1997. Mathematical Model Setup of the Dependence between the Hydrodynamic Parameters of Hydrogravimetric Concentration of Ash Processing in Case of Thermoelectric Plant Ash Recycling, Proc. 6-th Int. Symp. on Mine Planning and Equipment Selection , Ostrava, pp.831;
- [3].Fu,X, Wang,Z, Tao, W 2002. Studies on Blended Cement with a large amount of Fly Ash, Cement and Concrete Research, , pp. 1153-1159;
- [4].Hetea, M. – Vitroceramic Products from the Recovery of Thermoelectric Plant Ashes (Romanian), In: Revista Materiale de Construcții nr.2/1978;
- [5].Ianceu, A 1973. Results Regarding The Usage Of Ashes And Breezes From Thermoelectric Plants To Produce Construction Materials (Romanian), 1st Conf. regarding the valorification of ashes from Thermoelectric Plants, Deva, pp.34;
- [6].Ilic, I, Andric, L, Kostovic, M, 2009. Investigation of Mechanical Properties of Portland Cement – Fly Ash Mixtures, Proc.13th Balkan Mineral Congress, vol. II, Bucuresti, pp. 792;
- [7].Jingbang, S, Hao, Li 1997. Fly Ash Utilization in China , 20th Proc. Int. Mineral Congress, Aachen, vol.5, , pp. 109;

- [8].Michalikova, F, Florekova L (1996. Magnetic separation of energetical fly ashes, 5-th Int. Symp. On the Reclamation Treatment and Utilization of Coal Mining Wastes, Ostrava, pp.267;
- [9].Michalikova, F, Florekova L 1995. Reclaiming Of Utility Components By Treatment Of Energetical Fly Ashes, Proc. 6-th Balkan Conference on Mineral, Ohrid, , pp..358;
- [10].Nagy, B, Gonteanu, A.- Possibilities of extracting iron from Thermoelectric Plant Ashes (Romanian), Revista Minelor, XXIII, nr.6/1972, pp.305;
- [11].R.Sârbu, C.Bădulescu, E.Traistă, I.Nedelcu, (2003), Using Industrial And Domestic Waste To Make Construction Materials (Romanian), OSIM, Romania, nr. A/00717/28.08,2003;
- [12].Voina, I.N., 1978. Establishing The Optimum Quantity Of Ash On Pure Mineralogical Compounds (Romanian), Communicate Construction Institute, Bucharest.
- [13].Voina, I.N. , Todor, D.N., 1978. Thermal Analysis Of Coal And Coal Ashes. In: Analytical Methods For Coal Products. Vol. II , Academic Press, New-York,
- [14].Voina, I.N. 1979. Orientation And Perspective In The Domain Of Industrial Wastes' Utilization In Construction Materials Domain. (Romanian), Scientific Communication Session, Construction Institute, Bucharest;
- [15].xxx Annual, (2009) – National Environment Agency, Hunedoara;  
xxx European Commission, Eurostat waste statistic, 2016.





## EVALUATION OF BÂC RIVER WATER QUALITY

Sîli Nicolae<sup>1</sup>, Apostu Izabela-Maria<sup>2</sup>

**Abstract:** *Water is a vital natural source, indispensable for life and society, being vulnerable and limited. Water consuming and non-consuming activities produce qualitative and quantitative changes on water resources, and the proper application of laws is a determining factor in maintaining their ecological balance. The Republic of Moldova seems to be a negative example in this regard. Although there are legislative regulations on the management of water resources and waste from anthropogenic activities, it seems that the nation encounters difficulties when it comes to their effective application or application of sanctions in situations where the law is not respected which is very well observed in the country. This paper presents an evaluation study regarding the water quality of the Bâc River, a river that crosses the country's capital and attracts attention by its deplorable state downstream of Chisinau: dark green color, unpleasant odor, lack of aquatic fauna, the presence of waste, and the lack of interventions in order to eliminate pollution sources and improve water quality.*

**Keywords:** *water pollution, water quality, assessment, Bâc, river*

### 1. INTRODUCTION

The Bâc River basin is located in the center of the Republic of Moldova. It has an area of approximately 2200 km<sup>2</sup>, crosses several cities and villages, including the capital - Chisinau, numerous agricultural lands, and feeds the Ghidighici artificial lake, from which it then continues its course to the southeast until it flows into the Dniester (Nistru) River (Figures 1-2) [1].

Within the river basin of the Bâc River, tens of thousands of economic units operate in the following sectors: food, agriculture, livestock, forestry, energy, transport and communications, trade, and services, etc. The Bâc River suffers from a large water deficit upstream of Chisinau, 45% of the river's sources being captured for the population's drinking water supply. The Bâc River is polluted with waste and discharged wastewater due to malfunction or lack of sewerage systems and treatment plants and the existence of dozens of illegally constructed landfills. In addition, agriculture is a polluting activity as a result of the inadequate management of pesticides and fertilizers [2-6].

Evaluation of water quality is a process of analysis, interpretation, and communication, which is based on the fundamental physical, chemical, biological and microbiological features.

---

<sup>1</sup> MSc Stud., University of Petrosani, Faculty of Mining, Environmental management and protection

<sup>2</sup> Assist.prof.dr.eng., University of Petrosani, Faculty of Mining, Department of Environmental Engineering and Geology

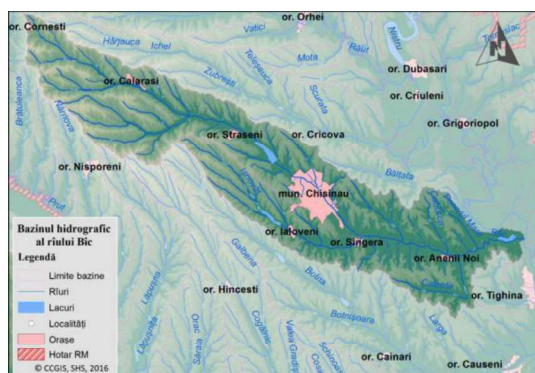

Figure 1. The river basin of the River Bâc [1]



Figure 2. Ghidighici artificial lake

In the Republic of Moldova, this process is carried out systematically, monthly, by the Environmental Reference Laboratory, subordinated to the Ministry of Agriculture, Regional Development and Environment of the Republic of Moldova. Although the name "monthly bulletin" indicates the frequency with which monitoring and quality assessments should be performed, at the level of the Bâc River the time interval between analyzes was 2, 3 or 5 months. This fact denotes the low interest or inability of the state to maintain a high quality of water resources, of the components of the environment in general, and last but not least, of the quality of life.

## 2. MATERIALS AND METHODS

In order to assess the quality of surface and groundwater, each country has its own law governing the issues of rational management of water resources in its territory. Water Law no. 272/2011 [7] is valid on the territory of the Republic of Moldova and the Water Law no. 107/1996 [8] is valid on the Romanian territory. To establish the reference points to which we can report the results of the quality analyzes and to be able to carry out an adequate evaluation of the water quality of the Bâc River, the laws applied in the two countries were studied comparatively. The purpose of this comparative study was to assess the degree of permissiveness or restrictiveness that the Republic of Moldova has towards Romania. The results of this paper will relate to more restrictive regulations, as they are those that ensure a better quality of water resources and thus life. According to Order no. 161/2006 [9] and Decision no. 890/2013 [10], 5 ecological states for rivers and natural lakes were established based on biological, hydromorphological, chemical, and physico-chemical quality elements (Table 1). For lakes, the degree of trophic is also taken into account, the 5 ecological states corresponding to 5 degrees of trophic: ultra-oligotrophic, oligotrophic, mesotrophic, eutrophic and hypertrophic. For artificial or irreversibly modified aquatic ecosystems, 3 classes have been established depending on the ecological potential: very good (E), good (B) or moderate (M) ecological potential.

Overall, both legislative regulations are favorable in terms of environmental protection, but the Republic of Moldova does not apply the law properly, thus resulting in major pollution of environmental components.

**Table 1.** Quality classes according to Order no. 161/2006 of Romania and Decision no. 890/2013 from the Republic of Moldova (extracted part)

No.	Group of indicators	Parameters	Unit of measurement	Maximum Permissible Concentrations *									
				Quality class									
				I		II		III		IV		V	
RO	MD	RO	MD	RO	MD	RO	MD	RO	MD	RO	MD		
1	Physical indicators	Temperature	°C	-	natural variations in temperature	-	cold water: 20 °C summer, 5 °C winter; warm water: 28 °C summer, 8 °C winter	-	cold water: 20 °C summer, 5 °C winter; warm water: 28 °C summer, 8 °C winter	-	cold water: >20 °C summer, >5 °C winter; warm water: >28 °C summer, >8 °C	-	cold water: >20 °C summer, >5 °C winter; warm water: >28 °C summer, >8 °C
2		pH	pH units	6,5 – 8,5	6,5 – 8,5	6,5 – 8,5	6,5 – 9,0	6,5 – 8,5	6,5 – 9,0	6,5 – 8,5	6,5 – 9,0	6,5 – 8,5	< 6,5 or > 9,0
3		Suspensions	mg/l		<10		10		25		50		> 50
4	Oxygen regime	Dissolved oxygen	mgO <sub>2</sub> /l	7	> 8	6	> 7	5	> 5,5	4	> 4	< 4	< 4
5		CBO <sub>5</sub>	mgO <sub>2</sub> /l	3	3	5	5	10	6	25	7	> 25	> 7
6		CCO <sub>Cr</sub>	mgO <sub>2</sub> /l	10	< 10	25	15	50	30	125	90	> 125	> 90
7		Nutrients	NH <sub>4</sub> <sup>+</sup>	mg/l	0,2	0,2	0,3	0,4	0,6	0,8	1,5	3,1	> 1,5
8	NO <sub>2</sub> <sup>-</sup>		mg/l	0,01	0,01	0,06	0,06	0,12	0,12	0,3	0,3	> 0,3	> 0,3
9	NO <sub>3</sub> <sup>-</sup>		mg/l	1	1	3	3	6	5,6	15	11,3	> 15	> 11,3
10	Total N		mg/l	1,5	1,5	4	4	8	8	20	20	> 20	> 20
11	PO <sub>4</sub> <sup>3-</sup>		mg/l	0,05	0,05	0,1	0,1	0,2	0,2	0,5	0,5	> 0,5	> 0,5
12		Total P	mg/l	0,1	0,1	0,2	0,2	0,4	0,4	1	1	> 1	> 1
13	General ions, salinity	Dry filterable residue at 105°C	mg/l	fond		500		1000		1300		> 1300	
14		Ca <sup>+2</sup>	mg/l	75		150		200		300		> 300	
15		Cl <sup>-</sup> (cloruri)	mg/l	fond	< 80	100	150	250	250	300	300	> 300	> 300
16		SO <sub>4</sub> <sup>2-</sup>	mg/l	80	< 100	150	150	250	200	300	350	> 300	> 350
17	Organic substances	Fenols	µg/l	fond	< 1	1	1	20	5	50	100	> 50	> 100
18		Detergents	µg/l	fond		500		750		1 000		>1 000	
19		Fecal coliforms	col./100 ml	100	100	2 000	2 000	> 2 000	10 000		20 000		> 20 000

\*Ro – Romania; MD – Republic of Moldova; very good ecological status; good ecological status; moderately polluted / moderate ecological status; polluted / poor ecological status; very polluted / very poor ecological status

### 3. RESULTS AND DISCUSSIONS

#### 3.1. Bâc river water quality

The analysis of the water of the Bâc River is performed at the Environmental Reference Laboratory. In Figure 3 the water quality monitoring points are presented, and

in Table 2 are centralized the results of the analyzes from the existing bulletins [11], from August 2019 to March 2021.

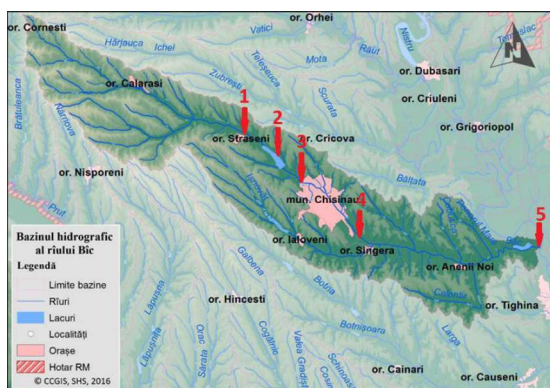

1. Strășeni city, downstream;
2. Vatra city, Ghidighici lake;
3. Chișinău city, upstream;
4. Chișinău city, downstream;
5. Gura Bâcului village;

Figure 3. Bâc River – monitoring points

Table 2. The centralized results of the analyzes of Bâc River water

Investigated parameters	Substances in suspension	Dissolved O <sub>2</sub>	CCO <sub>2</sub>	CBO <sub>5</sub>	Durity	Mineralization	Ammonium nitrogen	Nitrite nitrogen	Nitrate nitrogen	Mineral phosphorus	Total phosphorus	Petroleum products	
Unit of measurement	mg/l		mgO <sub>2</sub> /l		Mmol/l	mg/l	mgN/l			mgP/l		mg/l	
Monitoring point	CMA	25	min. 6.0 – summer. 4.0	15	3.0	6.0	1000.0	0.8	0.12	5.6	0.2	0.4	0.05
Data													
Strășeni city, downstream	13.11.2019	-	0.25	-	11.86	9.8	-	23.39	-	-	0.21	0.35	-
	12.02.2020	-	3.30	-	9.96	-	-	14.55	5.84	-	-	1.92	0.25
	10.04.2020	-	-	39.16	8.61	-	-	-	-	-	2.69	3.13	-
	15.07.2020	-	2.84	-	6.72	-	-	10.95	-	-	1.643	1.759	-
	15.10.2020	-	2.54	-	11.24	6.85	1355.0	6.534	0.32	-	1.278	1.805	-
Ghidighici Lake	11.03.2021	-	11.88	12.85	3.64	6.1	1503.7	1.445	-	1.71	0.46	0.51	0.013
	13.11.2019	-	-	-	-	8.8	-	2.64	-	-	2.06	7.38	-
	10.04.2020	56.0	-	32.12	-	-	-	-	-	-	-	-	-
Chișinău city, upstream	15.10.2020	-	-	-	-	-	983.0	-	-	-	0.152	0.359	-
	11.03.2021	-	14.92	16.96	2.62	2.45	829.5	0.202	-	0.08	0.02	0.03	0.03
	17.12.2019	-	-	-	8.06	-	-	1.93	0.145	3.78	0.78	0.97	-
	12.02.2020	-	-	-	-	-	-	1.88	0.27	4.10	-	0.365	-
	10.04.2020	-	-	124.30	-	-	-	-	0.12	-	0.273	0.274	-
Chișinău city, downstream	15.07.2020	-	4.32	-	5.54	-	-	1.678	-	-	0.249	0.341	-
	12.10.2020	-	6.33	-	9.04	-	831.0	0.466	-	-	0.303	0.434	0.169
	11.03.2021	-	12.2	29.3	7.08	5.9	1031.3	1.738	-	1.18	0.2	0.32	0.026
	17.12.2019	-	0.74	-	24.37	-	-	46.0	0.095	-	4.33	4.66	-
	13.02.2020	-	0.86	-	14.86	-	-	10.8	0.17	-	-	0.98	-
Gura Bâcului village	10.04.2020	83.6	0.70	290.1	59.56	-	-	6.02	-	-	2.05	2.34	-
	15.07.2020	-	0.61	-	14.01	-	-	11.43	-	-	1.155	1.721	0.223
	12.10.2020	-	0.85	-	22.64	-	987.0	5.805	-	-	1.796	1.941	0.124
	11.03.2021	-	0.52	277.56	41.8	4.3	3044.7	52.39	-	2.37	1.92	2.15	0.184
	20.08.2019	86.8	0.55	59.76	25.96	-	-	-	-	-	1.655	1.842	-
Gura Bâcului village	19.11.2019	30.0	2.14	-	10.16	6.35	-	26.14	-	-	1.81	2.55	-
	18.02.2020	-	2.70	-	9.66	-	-	11.18	-	-	-	2.01	-
	21.07.2020	-	2.81	61.0	14.81	-	-	7.02	0.131	-	1.515	2.49	0.122
	23.10.2020	-	0.81	-	23.2	-	1358.0	5.905	-	-	0.929	1.815	-
	16.03.2021	-	1.72	61.17	17.21	5.4	1218.3	13.502	-	0.04	1.4	2.01	0.09

It is important to mention that, following a simple visual analysis, the water quality at the spring was estimated as good, clear, without color or odor, downstream of Chisinau the aquatic life being present. The analysis of the water from the Bâc River performed by the Environmental Reference Laboratory, shows that the norms of the basic indices are significantly exceeded. Oxygen levels are reduced dozens of times, especially at the monitoring point downstream of Chisinau, after the wastewater from the city's wastewater station flows into the river.

According to the assessments, the Bâc River is in the 5th class of quality in all monitoring points with one exception, the Ghidighici lake which is in a moderate ecological status. The Vth class corresponds to surface waters that have major alterations in the physical-chemical and biological values of the natural background of water quality, as a result of human activities. The biological components, especially fish, are damaged and the water cannot be used for drinking purposes. It is found that the water from the Bâc River negatively influences the biodiversity in the area. Also, the water from the river downstream of the city is not recommended to be used for irrigation.

The Ghidighici lake is located between the monitoring points downstream of the Straseni city and upstream of Chisinau city. The water quality of the Bâc River at the entrance and exit of Ghidighici lake has a very big difference. According to the results from the points before and after the lake, there is a significant reduction of the maximum permissible concentrations for some indicators. This fact indicates the existence of supply sources (underground or surface) of the lake with qualitative waters and identifies Ghidighici lake as a reservoir for diluting the water from the Bâc River.

### **3.2. Evaluation of water quality using the global impact index method ( $I_{GI}$ )**

The method makes it possible to express the state of the environment based on a ratio between the ideal value and the value at a given time of the quality indicators specific to the analyzed environment, thus obtaining an index called the global impact index ( $I_{GI}$ ).

In order to assess the environmental condition both in a situation considered ideal and in the situation in which it is affected by anthropogenic activities, creditworthiness scales are used for environmental factors and environmental components that include grades from 1 to 10, when 1 corresponds to a particularly serious situation of deterioration of the analyzed environmental factors and 10 corresponds to the natural state, unaffected by anthropogenic activities.

Depending on the credit ratings that define the environment in the initial situation (natural environment, unaffected by anthropogenic activities) and in the case of a project, two polygons are built (with three, four or more sides, depending on the number of environmental components analyzed), one of which illustrates the ideal state, and the other the state affected by the impacts generated by a certain project. The global impact index is calculated by reporting the areas of the two polygons (Formula 1) [12-15].

$$I_{GI} = \frac{S_i}{S_r}; \quad S_i > S_r \quad (1)$$

where:

$S_i$  – the ideal surface/the surface of the geometric shape corresponding to the state considered ideal;

$S_r$  – the actual surface/the surface of the geometric shape corresponding to the real state;

The evaluation method using the global impact index has several advantages, including the following: it provides an overview of the state of the environment, allows comparison of different areas by analyzing them based on the same indicators and allows analysis of time dynamics of an area.

In this case, the creditworthiness grades were given according to the quality classes in which the water was classified in each monitoring point and for each selected indicator (dissolved  $O_2$ ,  $CCO_{Cr}$ , Mineralization, and Total Phosphorus), as it follows: for the I<sup>st</sup> quality class, grade 10 was awarded; for the II<sup>nd</sup> quality class, grade 8 was awarded; for the III<sup>rd</sup> quality class, grade 6 was awarded; for the 4<sup>th</sup> quality class, grade 4 was awarded; for the 5<sup>th</sup> quality class, grade 2 was awarded.

We evaluated the global impact index for each monitoring point, using the results of the latest analyzes, from March 2021, for each of the 4 mentioned indicators, as shown in Table 3 and Figure 4.

**Table 3.** Creditworthiness grades - March 2021 [2]

Punctele de prelevare	Dissolved $O_2$	$CCO_{Cr}$	Mineralization	Total phosphorus
1. Strășeni city, downstream	10	8	4	4
2. Vatra city, Ghidighici lake	10	6	6	10
3. Chișinău city, upstream	10	6	4	6
4. Chișinău city, downstream	2	2	2	2
5. Gura Bâcului village	2	4	4	2

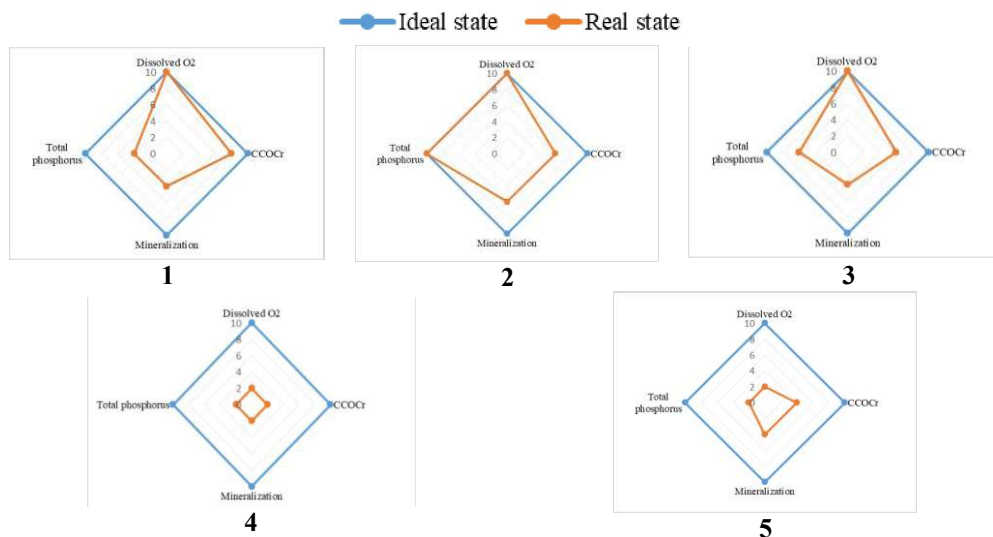

**Figure 4.** Determination of the global impact index for monitoring points 1 – 5 [2]

By calculation of the ideal and real surfaces, the values of the global impact index for each monitoring point were determined, as follows:  $I_{GI1} = 2.38$ ,  $I_{GI2} = 1.61$ ,  $I_{GI3} = 2.38$ ,  $I_{GI4} = 25$ ,  $I_{GI5} = 8.33$ .

Depending on the value of the global impact index, the aquatic environment, but also the environment in general, can be defined as follows [12, 14]:

- $I_{GI} = 1$  - natural aquatic environment unaffected by anthropogenic activity;
- $I_{GI} = 1 - 2$  - aquatic environment subjected to anthropogenic activity within permissible limits;
- $I_{GI} = 2 - 3$  - aquatic environment subjected to anthropogenic activity, causing discomfort to life forms;
- $I_{GI} = 3 - 4$  - aquatic environment subjected to anthropogenic activity, causing disturbances of life forms;
- $I_{GI} = 4 - 6$  - aquatic environment severely affected by anthropogenic activities, dangerous for life forms;
- $I_{GI} > 6$  - degraded aquatic environment, unsuitable for life forms.

Therefore, we can establish that Lake Ghidighici is subjected to anthropogenic activities within the allowable limits, while the Bâc River, at the monitoring points downstream of Straseni city and upstream of Chisinau city is also subjected to anthropogenic activities but causing discomfort to life forms, and water downstream of Chisinau city, up to the drain near the village of Gura Bâcului, is very polluted, degraded and unsuitable for life.

It is found that, although favorable credit grades were given for all situations (the highest value that can be given for each quality class: 2, 4, 6, 8, and 10 instead of 1, 3, 5, 7, and 9, grades which could also have been given), the values obtained indicate that the situation is critical.

Thus, we propose the elimination of current pollution sources, if possible, and investments in order to modernize wastewater treatment plants and resize them so as to ensure the collection and disposal of the entire amount of domestic and industrial wastewater, construction of compliant landfills and proper management of pesticides and fertilizers in agriculture, these representing the main sources of pollution of the Bâc River.

### **3.3. Highlighting the causal factors using the monitoring matrices method**

The matrix method allows a representation of the relationships between different categories of terms that intervene in an environmental assessment process. The relevant actions are represented on the matrix lines, and the list of causal factors is represented on the matrix columns [14, 16].

In order to solve the proposed problem, the evaluation was performed for three anthropogenic activities considered polluting for Bâc River: agriculture, urbanization, and landfills (Table 4), on two different typologies of areas through which the river passes: natural areas and urbanized areas.

**Table 4.** The relationships between the relevant actions and the list of causal factors [2]

Relevant actions/activities	Causal factors									
	Emissions of macro-	Emissions of micro-pollutants	Radioactive emissions	Noise emissions	Water consumption	Wastewater discharge	Flooding of surfaces	Land occupation	Waterproofing of soil	Car traffic
Agriculture	I	P			S	P		I	I	I
Urbanization	P	S		S	S	S		S	S	S
Landfills	S	S			I	P		S	I	P

The existence of a relationship between a relevant action and a causal factor is highlighted by marking the cell at the intersection of the line representing the action with the column corresponding to the causal factor with various symbols. In the present case, the symbols used describe the existing relationship as certain (S), probable (P), uncertain (I) or null.

**Table 5.** Hierarchy of the need to monitor causal factors [2]

Priority	Relevant actions/activities		
	Agriculture	Urbanization	Landfills
1	Water consumption Wastewater discharge	Wastewater discharge Water consumption Waterproofing of soil Car traffic	Emissions of macro-pollutants Wastewater discharge
2	Car traffic	-	Water consumption
3	Waterproofing of soil Emissions of macro-pollutants	Emissions of macro-pollutants Emissions of micro-pollutants Land occupation	Waterproofing of soil
4	Land occupation Emissions of micro-pollutants	Noise emissions	Emissions of micro-pollutants Land occupation Car traffic

Going through all the specific steps of this method, we identified that the main causal factors that determine water pollution are water consumption and wastewater discharge. Analyzing the hierarchy of the need to monitor the causal factors (Table 5) it was found that it is imperative to monitor the activity of wastewater discharge (domestic wastewater, industrial, leachate, etc.). Wastewater is, maybe, the main cause of pollution of the Bâc River.

#### 4. CONCLUSIONS

The water quality of the Bâc River deteriorates considerably from the spring to the place where it flows into the Dniester River, generally presenting itself in a poor or very poor state (polluted or very polluted). In the monitoring point located downstream of Chisinau city, the capital of the Republic of Moldova, it is found that the water is in the worst quality state throughout its entire course. Water quality degrades as it encounters new and new sources of pollution. In the lower course the water has a state unsuitable for life compared to the upper and middle course. Following the ranking of



causal factors, it was found that wastewater discharges are among the main factors, or even the main one, that determine the pollution of the River Bâc and must be monitored.

Even if the legislation in force is appropriate, the major problem is their breach, inadequate management of drinking water resources and wastewater and the lack of verifications made by the competent authorities in order to ensure a proper water management in all sectors of activity.

#### 4. REFERENCES

- [1]. Ministry of Environment, State Hydrometeorological Service, Environmental Quality Monitoring Directorate, Annual Report, State of surface water quality according to hydrochemical indices on the territory of the Republic of Moldova in 2015 (in Romanian), Republic of Moldova (2015).
- [2]. Sîli N., Identification of pollution sources of the river Bâc and assessment of quality status, (in Romanian), Bachelor's thesis, Petroșani (2021).
- [3]. Mustea M., Ecological situation in the Bâc River Basin (in Romanian), National Environmental Center, Chișinău (2013).
- [4]. Vlădicescu V., Postolachi L., Environmental Management Plan, Rainwater Sewerage Project, Promotion and Implementation of Innovative Climate Change Actions, (in Romanian), Chișinău (2010).
- [5]. Faur F., Apostu I.M., Lazăr M., Study regarding the water quality of Jiu River in Dolj county, Research Journal of Agricultural Science 49(4), pp 118-127 (2017).
- [6]. Faur, F., Lazăr, M., Apostu, I.-M., Pinchuk, O., and Klimov, S., Monitoring the water quality of Jiu River in Dolj County, Ukraine, E3S Web of Conferences 280, 10002 (2021).
- [7]. Water Law no. 272/2011, Republic of Moldova.
- [8]. Water Law no. 107/1996, Romania.
- [9]. Order no. 161/2006, Regulation on the classification of surface water and sediment quality (in Romanian), Romania.
- [10]. Decision no. 890/2013 for the approval of the Regulation on environmental quality requirements for surface waters (in Romanian), Annex 1, Republic of Moldova.
- [11]. \*\*\*, Monthly bulletin on the quality of the environment on the territory of the Republic of Moldova (in Romanian). <http://www.mediu.gov.md/ro/node/215> Accessed in may 2021
- [12]. Lazăr M., Faur F., Identification and evaluation of the anthropic impact on the environment (in Romanian), Universitas Publishing House, Petroșani (2011).
- [13]. Lazăr M., Surface water management (in Romanian), Universitas Publishing House, Petroșani (2001).
- [14]. Ciolea D.I., Dumitrescu I., Pollution and environmental protection (in Romanian), Universitas Publishing House, Petroșani (2012).
- [15]. Munteanu C., Ecology and Environmental Quality Protection (in Romanian), Balneară Publishing House, București (2011).
- [16]. H.G. 1076/2004 concerning the establishing of procedure for carrying out the environmental assessment for plans and programs, published in the Official Monitor, part I no. 707 from 5 august 2004.



## ANALYSIS OF THE THERMAL AND PLUVIOMETRIC REGIME IN RAMNICU VALCEA, IN THE CONTEXT OF CLIMATE CHANGE

Nimară Ciprian <sup>1</sup>

**Abstract:** *Climate change is one of the most important issues today. We must be aware that we no longer have the same climate as in the past, that the weather is warming and becoming more and more changeable. The most important parameter is the increase in average temperature. But people do not feel the average temperature. They notice only the concrete consequences. Climate change over the last 30 years has had a negative impact on how classic meteorological phenomena have become a danger to communities, infrastructure and the environment. This paper aim to highlight this aspect on the city of Râmnicu Vâlcea, Romania.*

**Key words:** *climate change, air temperature, precipitation, Ramnicu Valcea*

### 1. INTRODUCTION

Râmnicu Vâlcea is located in the Getic Subcarpathians, 18 km away from the Olt gorge, in the river meadow and forms at the confluence with the Olănești river a hook area with N-W orientation. The maximum width of the meadow is 2.5 km in the North, 1.9 km in the central area and 2 km in the South. The city is located on the terraces of the major riverbed of Olt river, which are highlighted more in the West, because in the East the hills descend too close to the water. In the past, the urban agglomeration was arranged on the upper terrace, due to the frequencies of the floods. Later, after the hydroelectric arrangement of Olt, the living area was extended on the lower terrace. The western part of the city extends along the Olănești River, most of the buildings being located on the left bank of this river.[4]

The city borders the following localities: Bujoreni commune to the North, Dăești and Golești communes to the Northeast, Budești commune to the East, Ocele Mari town to the West, Mihăești commune to the Southwest and Vlădești commune to the Northwest. It stretches East of Capela Hill, beyond the course of the Olt River, passing to the South its confluence with the waters of the Olanesti River. It is bordered on the South by Troian Hill, and on the Southwest by Petrișor Hill. To the North, the border of the locality is marked by the Cetățuia hill. It is located at almost equal distances, approx. 20 km, from three important balneo-climatic resorts: Călimănești-Căciulata-Cozia, Băile Olănești and Băile Govora.

---

<sup>1</sup> lecturer Ph.D., University of Petroșani, Mining Faculty, Department of Environmental Engineering and Geology ( E-mail: ciprian.nimara@yahoo.com)

The municipality is vulnerable to risky climatic phenomena, especially those with rapid development, such as torrential rains, lightning, hail, but also to frost and frost phenomena in the off-season.

## **2. THE EVOLUTION OF THE THERMAL REGIME**

In Râmnicu Vâlcea the impact of climate change was felt as well, 2019 being the warmest year in the last three decades, with an average of annual air temperature of 12.7°C, while the lowest average annual temperature of 9.9°C was registered in 1991. The absolute maximum of the last thirty years was 40.7°C and was registered in August, 2012, and the absolute minimum of -22.9°C was registered in January, 2000.

Analyzing the increase of the average monthly air temperature over decades, it is observed that in the period 1991-2020 it registered a continuous increase, from 0.4 °C in January to 2.5°C in September. The highest values of the average monthly air temperature were registered in July, and the lowest in January. There has also been an increase in the average multiannual air temperature over the last 30 years (figure 1) of 1.2°C, an increase of 0.4°C between the first and second decades and a double increase between the second and third decades, of 0.8°C.

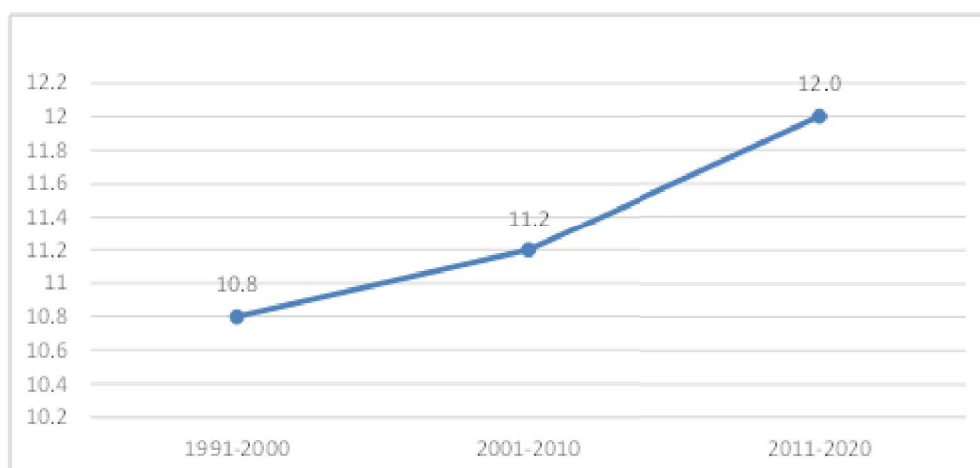

**Figure 1.** Rising average air temperature for decades

## **3. THE EVOLUTION OF THE PLUVIOMETRIC REGIME**

Atmospheric precipitation is the component element of the climate that is reflected, to a large extent, in the geographical landscape and in the agricultural economy of any region.

In winter, the lowest amounts of precipitation are generally added, due to the low water vapor content of the air masses, conditioned by the lowered temperatures. In spring the average monthly quantities are more abundant. The highest quantities are recorded in summer and an appreciable decrease is observed in autumn. The highest amount of precipitation is recorded between April and October.

Analyzing the April-October interval, the monthly average of the amount of precipitation in Râmnicu Vâlcea, in the period 1991-2020 registers an ascending course from April to June. From June to September there is a decrease in the average amount of rainfall, so that in October it increases slightly.

One month was free of precipitation, namely August 2008. The month with the most significant amount of precipitation was July 2014, the year that totaled the highest amounts of precipitation in the analyzed period (240.4 mm).

In the period 1991-2020, no clear significant trend of changing precipitation amounts was identified, alternating rainy and dry periods.

The highest amounts of precipitation in the last thirty years were recorded in 2014 and amounted to 1135.0 mm, and the lowest amounts totaled in 2000, being only 350.2 mm (figure 2).

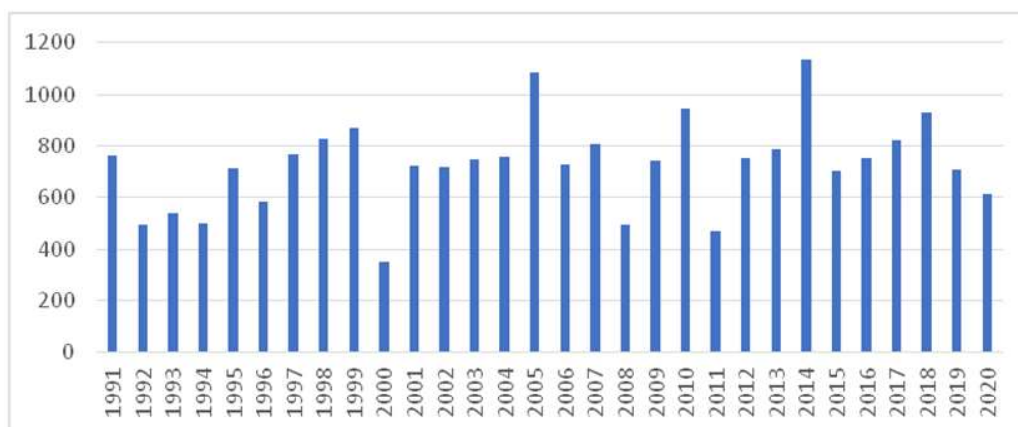

**Figure 2.** Annual amount of precipitation during 1991-2020

#### 4. DEVIATIONS FROM MONTHLY AND MULTIANNUAL AVERAGES

Regarding the thermal regime, the last decade (2011-2020) recorded the highest values of the average air temperature from 1991-2020. In Table 1 and 2 I have compared the average air temperature of this decade to the multiannual average of the last thirty years.

**Table 1.** Reporting of the average air temperature from 2011-2020 to the multiannual average (January - June)

Decade/ Month	I	II	III	IV	V	VI
2011-2020	-0,2	2,2	7,2	12,6	16,8	21,0
Monthly average	-0,4	1,6	6,2	11,8	16,7	20,5
Deviation	0,2	0,6	1,0	0,8	0,1	0,5

**Table 2.** Reporting of the average air temperature from 2011-2020 to the multiannual average (July - Decembre)

Decade/ Month	VII	VIII	IX	X	XI	XII	Average/ decade
2011-2020	22,9	22,9	18,5	11,8	6,6	1,9	12,0
Monthly average	22,4	22,1	16,9	11,4	5,9	0,9	11,3
Deviation	0,5	0,8	1,6	0,4	0,7	1,0	0,7

From this tables, it is noted that the air temperature in 2011-2020 shows a deviation from the multiannual temperature of 0.7°C.

Figure 3 shows that the air temperature of the last decade is a deviation from the average monthly temperature throughout the year, with values between 0.2 oC in January and 1.6°C in September.

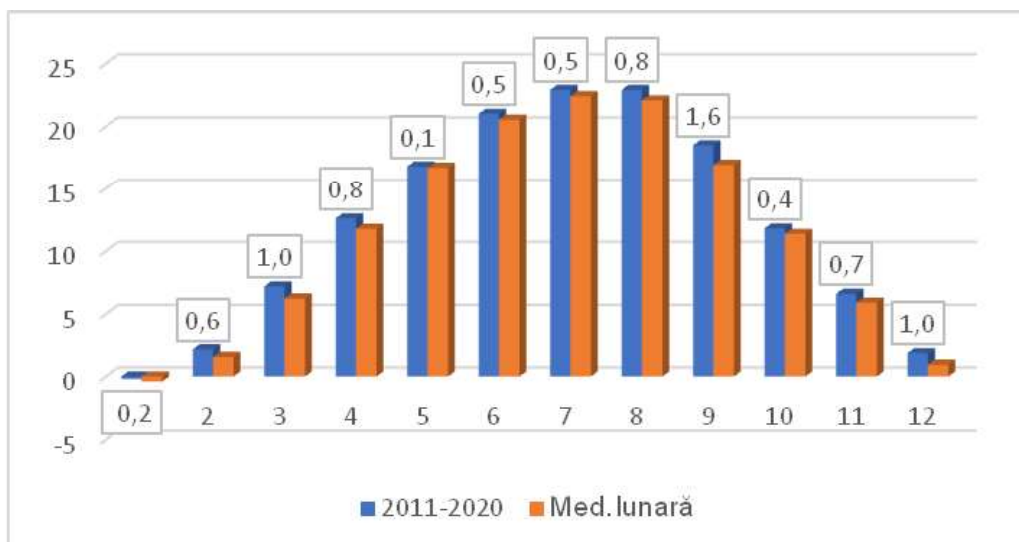

**Figure 3.** Deviations of the average monthly air temperature in the last decade compared to the monthly average of the last 30 years

The temperature increases in both the hot and cold seasons fragment the city's temperate continental climate into one with shades of excess.

Regarding the pluviometric regime it is found that the highest amounts of precipitation in the last thirty years were recorded in 2014 and amounted to 1135 mm, 407 mm more than the multiannual average. Next, I reported the amount of precipitation from the rainiest year, 2014 to the multiannual average of the amount of precipitation from 1991-2020.

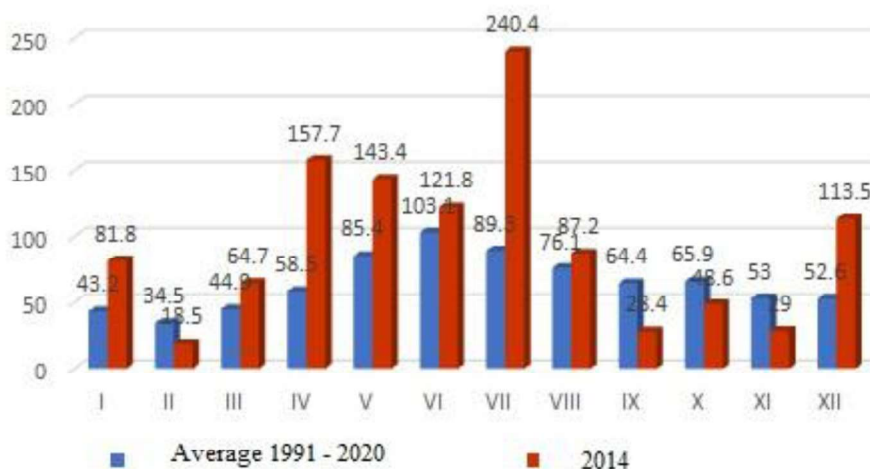

**Figure 4.** The amount of precipitation in 2014 compared to the multiannual average

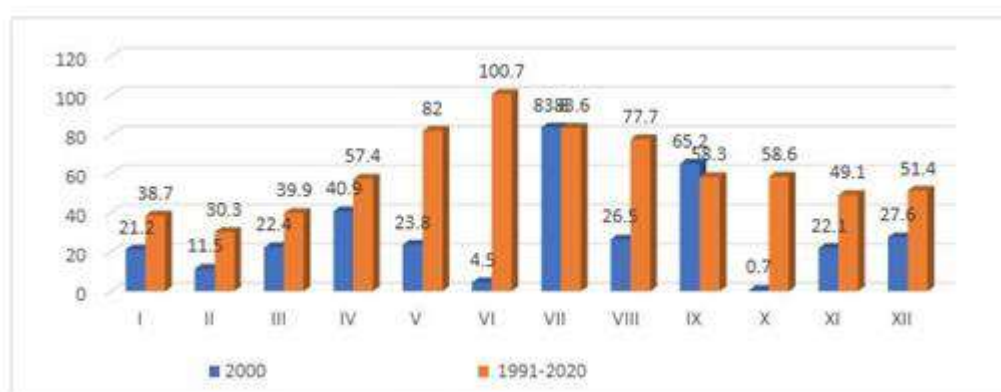

**Figure 5.** The amount of precipitation in 2000 compared to the multiannual average

Figure 4 shows that the highest amount of precipitation in 2014 amounted to July, when the amount was almost 3 times higher than the multiannual average, and in April the difference was 2.7 times higher. In January and December the amount was double compared to the multiannual average. The only months in which the multiannual average was not exceeded were the months of the cold period of the year: September, October, November and February.

The lowest amounts of precipitation in the last three decades totaled in 2000 being 350.2 mm, half of the multiannual average (figure 5).

It is noted that the only months in which the amount of precipitation in 2000 exceeds the multiannual average are July and September, with a deviation between 0.2 mm and 6.9 mm. The lowest rainfall in 2000 was recorded in October (0.7 mm), when the accumulated amount was almost 84 times lower than the multiannual average, and in June the amount was 22 times lower than the multiannual average.

## **5. CONCLUSIONS**

We must be aware that we no longer have the same climate as in the past and that changes will continue in the future. Heat waves and hot summers will be more frequent, even if we keep global warming below 2°C. Climate change over the last 30 years has negatively influenced how classic weather events have become a danger to communities, infrastructure and the environment [1, 3]. A warmer world is expected to lead to extreme weather conditions, with more rainfall during rainy periods, longer periods of drought and much stronger storms and blizzards.

New records are still being reached in terms of average air temperatures, in the last 30 years, in Râmnicu Vâlcea, with an increase of this temperature of 1.2°C. There is also a continuous increase in the average temperature throughout the year, the largest deviation being recorded in September, and being 2.5°C. The warmest year of this period, with an average temperature of 12.7°C, was 2019, while the lowest average temperature of 9.9°C was recorded in 1991. Due to the increase in average temperature, the amount increases of humidity in the atmosphere, which leads to the formation of torrential rains.

## **6. REFERENCES**

- [1]. Nimară C., Analysis of climate indicators with a specific role in tourist activities from the Petroșani Depression. Case study: thermal regime, *Annals of the University of Petroșani, Mining Engineering*, 21 (2020), ISSN 1454-9174;
- [2]. \*\*\* *Adapting to the Impacts of Climate Change*, (2010). National Research Council;
- [3]. \*\*\* *Impacts of Europe's changing climate. An indicator-based assessment*, European Environment Agency, Report No 2 (2004);
- [4]. \*\*\* *Primăria Municipiului Râmnicu Vâlcea*, (2017), *Strategia integrată de dezvoltare urbană 2014-2020 a Municipiului Râmnicu Vâlcea*, Râmnicu Vâlcea;
- [5]. \*\*\* [www.meteoromania.ro](http://www.meteoromania.ro);
- [6]. \*\*\* [www.inmh.ro](http://www.inmh.ro);



## THE INFLUENCE OF URBAN CLIMATE ON THE RESIDENTS OF RÂMNICU VALCEA CITY

Nimară Ciprian <sup>1</sup>

**Abstract:** *The urban climate is more aggressive for humans, compared to the rural one, because it allows the temperature to rise and the air to heat up strongly, the city being considered a “heat island”. A noticeable role in the appearance of the thermal superiority of the city is also played by the lower humidity of the urban air. This paper aims to analyze the evolution of the annual average temperature values, the temperature-humidity index, thermal inversions and the role played in the influence on the residents of Râmnicu Vâlcea city, Romania.*

**Keywords:** *urban climate, temperature-humidity index, thermal inversion*

### 1. INTRODUCTION

Environmental factors constantly act on the human body, forcing it to react to all stimuli, the climatic component of the geographical environment also requires a response from the body, so some climatic parameters can be analyzed as bioclimatic indices, and an example in this is also the number of summer days. The number of hot days is higher in cities, due to the influence of urban climate, where ventilation is lower, and neighborhoods of compact blocks prevent sufficient air ventilation, compared to scattered houses in villages, gardens and green spaces, which determine a temperature relatively cooler. The urban climate is more aggressive for humans, compared to the rural one, because it allows the temperature to rise and the air to heat up strongly, the city being considered a “heat island”.

A noticeable role in the appearance of the thermal superiority of the city is also played by the lower humidity of the urban air.

The construction materials that cover most of the city's surface are practically impermeable, which prevents infiltration and favors the rapid flow of rainwater to the sewer system. In this way the heat that would be consumed to evaporate the water becomes available to heat the lower layer of urban air.

One of the controversial causes of the thermal superiority discussed is artificial heating. The role of artificial heating is challenged by the fact that if it contributes significantly to global warming, then the biggest differences should occur in the cold season. It seems that the role of this factor in creating urban thermal superiority differs depending on the general climatic conditions in the region where the city is located. It seems that in cities from regions that do not frequently register warm air advections during the winter (temperate continental climate) the role of artificial heating is more

---

<sup>1</sup> *lecturer Ph.D., University of Petroșani, Mining Faculty, Department of Environmental Engineering and Geology ( E-mail: ciprian.nimara@yahoo.com)*

important; in contrast, in regions with temperate oceanic climates, especially those influenced by warm ocean currents, the contribution of artificial warming is diminished by the frequent advections of warmer air during the winter.

## 2. TEMPERATURE - HUMIDITY INDEX

Thus, Râmnicu Vâlcea being a city in permanent development, I have analyzed the index of thermal discomfort in the summer months, June-August, of the years 2009-2018 (before 2009 and after 2018 there are no data in the data archive). Thermal discomfort in the hot season occurs when the air temperature exceeds 37°C or when the temperature-humidity index (ITU) exceeds the critical threshold of 80 units. When the thermal discomfort occurs, emergency measures are taken regarding the protection of the persons at work, applying the Government Emergency Ordinance no. 99/2000.

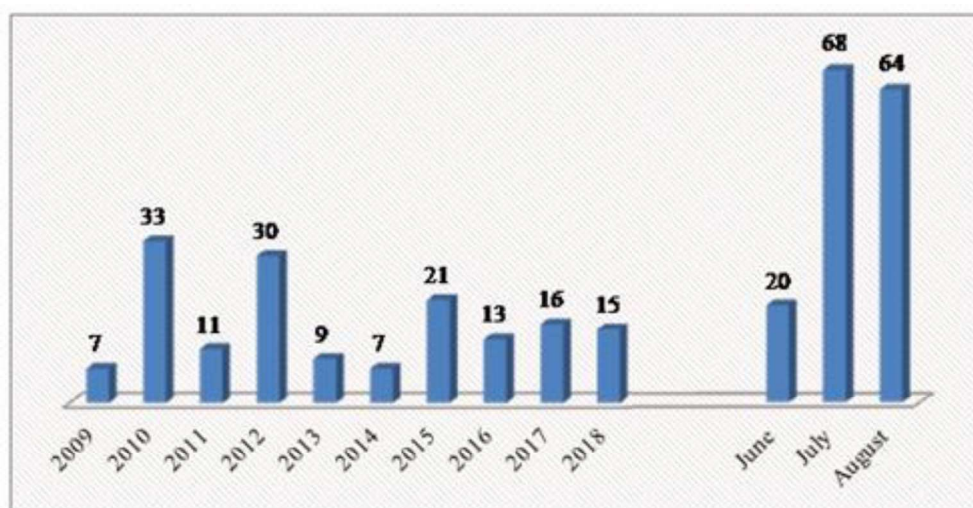

**Figure 1.** Number of THI over 80 units

Temperature-humidity index (THI) is calculated based on measurements from weather stations, including two factors:

- the air temperature in degrees Celsius, (which is taken in the shade, at the standard height of 2.00 m) this if it exceeds 35°C (heat wave);
- the relative humidity of the air, which is defined as the amount of water vapour in the atmosphere, measured in percent (%).

The parameters of these values refer to the period 2009-2018, June-August, the study made at the meteorological station Râmnicu. Vâlcea.

Following the analysis of the period 2009-2018 (June-August), it was found that the maximum value occurred on 07.08.2012, THI having 84 units, the air temperature having a maximum value of 39.9°C, and the air humidity being 20%.

It is observed that most cases with THI over 80 units occurred in 2010 (33 cases), and the least THI cases over 80 units occurred in 2018 (5 cases). Most cases with THI

over 80 units occurred in July (68 cases in all 10 years analyzed), followed closely by August (64 cases in all 10 years analyzed),

### 3. THERMAL INVERSION

It is formed by the cooling of the earth's surface and the air layer in the vicinity of the soil. The effect of this cooling is felt at heights from 10-15 m to 200-300 meters.

The temperature difference between the ground air and the altitude air can reach 10-15°C. The night cooling is higher as the longer is the night, the lower the amount of water vapor in the air and the clearer the atmosphere.

After sunrise, the earth's surface begins to heat up and the thermal inversion may disappear.

The town of Râmnicu Vâlcea is located in the Getic Subcarpathians. The climate of the Subcarpathians is the mildest in the whole county. No conditions are created for thermal inversions with sharp drops in temperature.

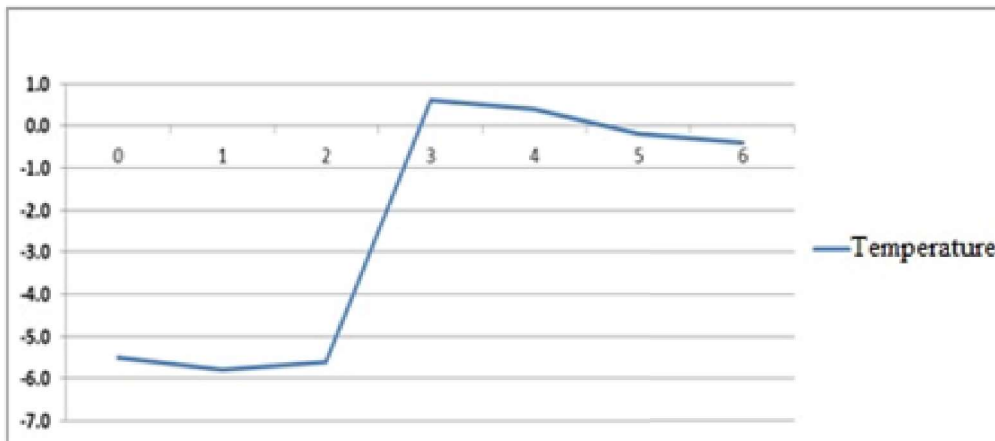
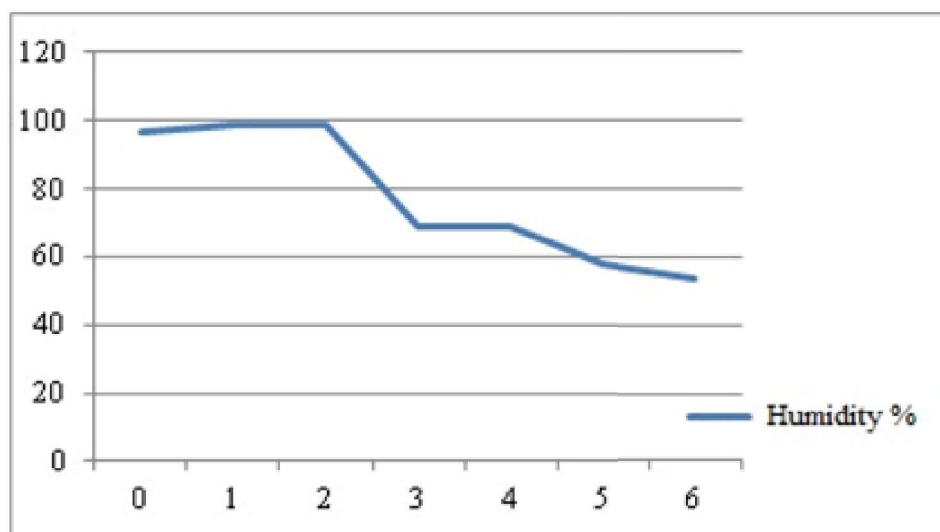

**Figure 2.** The air temperature per hour in Râmnicu Vâlcea on 15.01.2019

Râmnicu Vâlcea has a relative humidity of 74% (below the annual territorial average of 76%) and is explained by the high frequency of downward movements, which have the effect of heating the air and decreasing the relative humidity (thermal inversion phenomenon). Such a case occurred in Râmnicu Vâlcea on the night of 15.01.2019, between 02-03 AM (figure 1).

The air temperature increased from -5.6 °C at 02 AM to 0.6 °C at 03 AM, with an increase of 5 °C in one hour. This increase is significant considering that the phenomenon of thermal inversion occurred in winter, in January, where night temperatures are usually negative.

The relative humidity has dropped from 99% as of 02 AM to 69% as of 03 AM, with a 30% drop in one hour (figure 2).



**Figure 3.** Humidity of the air per hour in Râmnicu Vâlcea on 15.01.2019

This figure shows that the humidity is inversely proportional to the air temperature. The increase in air temperature, respectively the decrease in air humidity in the time interval 02-03 AM, from 15.01.2019, indicates that a thermal inversion took place that night from which no other meteorological phenomena resulted.

**Table 1.** Meteorological parameters measured during thermal inversion

Hour	Temperature (°C)	Humidity (%)	Wind velocity (m/s)	Air pressure (mb)	Cloudiness (in tenth)
0	- 5.5	97	1.2	972	5
1	- 5.8	99	0.1	973	3
2	- 5.6	99	0.3	973	5
3	0.6	69	2.7	974	6
4	0.4	69	2.6	975	4
5	- 0.2	58	5	976	6
6	- 0.4	54	4.7	977	5

In the period 1981-2020, in Ramnicu Valcea the following were observed (figure 3):

- the average seasonal temperature has positive values in all four seasons (due to the characteristics of the analyzed area);
- the average difference of the seasonal temperature (20.8°C) expresses the contrast between winter and summer and shows the degree of continental climate;
- the average seasonal temperature of the two intermediate seasons, spring (11.4°C) and autumn (11.2°C), is very similar, this similarity is characteristic of the settlement of Râmnicu Vâlcea.



**Figure 4.** Non-periodic variation of the monthly average temperature in relation to the seasonal average in Râmnicu Vâlcea (1981-2020)

From one month to another the average monthly temperature shows variable changes, the cause of these changes being the intense atmospheric circulation and the thermal variation between the hot / cold season.

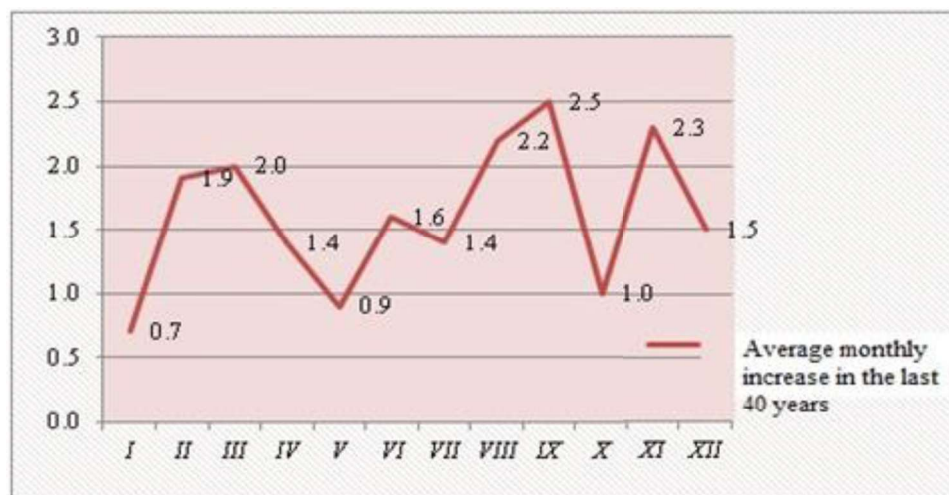

**Figure 5.** Rising of monthly average temperature in Râmnicu Vâlcea (1981-2020)

The analysis of the evolution of the annual average values in Râmnicu Vâlcea shows an increase of 1.4°C in the 40 years analyzed. The variability between the lowest increase (0.7°C) and the highest increase (2.5°C) being 1.8°C. It is very important to note that the highest increase was recorded in September (2.5°C), the increase being progressive from 16.0°C to 18.5°C (figure 4).

## **6. CONCLUSIONS**

The town of Râmnicu Vâlcea is located in the Getic Subcarpathians. The climate of the Subcarpathians is the mildest in the whole county. No conditions are created for thermal inversions with sharp drops in temperature. Râmnicu Vâlcea has a relative humidity of 74% (below the annual territorial average of 76%) and is explained by the high frequency of downward movements, which have the effect of heating the air and decreasing the relative humidity (thermal inversion phenomenon). The temperature difference between the ground air and the altitude air can reach 10-15°C.

Thermal discomfort in the hot season occurs when the air temperature exceeds 37°C or when the temperature-humidity index (ITU) exceeds the critical threshold of 80 units. It was observed that most cases with THI over 80 units occurred in 2010 (33 cases), and the least THI cases over 80 units occurred in 2018 (5 cases). Most cases with THI over 80 units occurred in July (68 cases in all 10 years analyzed), followed closely by August (64 cases in all 10 years analyzed),

## **6. REFERENCES**

- [1]. \*\*\* Adapting to the Impacts of Climate Change, (2010). National Research Council;
- [2]. \*\*\* Impacts of Europe's changing climate. An indicator-based assessment, European Environment Agency, Report No 2 (2004);
- [3]. \*\*\* Planul de menținere a calității aerului în județul Vâlcea perioada 2020-2024, Consiliul Județean Vâlcea;
- [4]. \*\*\* Primăria Municipiului Râmnicu Vâlcea, (2017), Strategia integrată de dezvoltare urbană 2014-2020 a Municipiului Râmnicu Vâlcea, Râmnicu Vâlcea;
- [5]. \*\*\* [www.meteoromania.ro](http://www.meteoromania.ro);
- [6]. \*\*\* [www.inmh.ro](http://www.inmh.ro);

## COMPARATIVE RISK ASSESSMENT FOR „DRILLING RIG OPERATOR“ IN OIL AND GAS ONSHORE DRILLING COMPANY

Moraru Roland Iosif<sup>1</sup>, Popescu-Stelea Mihai<sup>2</sup>

**Abstract:** *The present paper aims to develop a comparative analysis of the results obtained during the occupational health and safety risk assessment in the case of the workplace "drilling rig operator" which operates on two types of drilling rigs (F320-3DH and respectively Bentec 350t-AC) belonging to a Romanian oil and gas onshore drilling company. The obtained results are studied comparatively in order to observe the impact of the technological development on the reduction of the risk at work exposure. A well-established tool was used, but also - somewhat - controversial from the perspective of experts in this major field of activity, reaching conclusions that confirmed with certainty the positive impact of technological development on minimizing occupational risks and the validity of the method applied in the conditions of following the good practice recommendations.*

**Keywords:** *oil and gas drilling, drilling rig operator, occupational health and safety, risk assessment*

### 1. INTRODUCTION

It is well known that the starting point in the design and implementation of an effective occupational health and safety management system is always the assessment of risks at work. Although, in principle, risk assessment is a powerful and effective tool, if not used with caution and discernment, the results obtained may be completely incorrect, leading to erroneous decisions, practically inapplicable [1]. The risk assessment must be structured in such a way as to enable the analysis team to [2]:

- identify existing hazards and assess the risks associated with these hazards in order to establish measures to protect the health and safety of workers, in accordance with legal requirements;
- assess the risks for the optimal selection, in good faith, of the equipment, substances or chemical preparations used, as well as the arrangement and organization of workplaces;
- verify that the measures taken are appropriate;
- set both the priorities for action and the opportunity to take further action, following the analysis of the conclusions of the risk assessment;

---

<sup>1</sup> Professor, Ph.D., University of Petroșani

<sup>2</sup> Lecturer, Ph.D., University of Petroșani

- to confirm to employers, competent authorities, employees and / or their representatives that all relevant factors related to the work process have been taken into account;
- ensure that prevention / protection measures, considered necessary and adopted on the basis of risk assessment, contribute effectively to the improvement of occupational safety and health.

Regarding relatively immutable jobs [3] (offices, construction or garment workshops, etc.) risk assessment:

- will take into account the usual conditions;
- will not be repeated when jobs are comparable;
- will consider the need for a revised or different assessment when circumstances change, for example through the introduction of new equipment or technology [4].

In workplaces where circumstances and conditions change, evaluation involves an approach that facilitates the consideration of these changes. The choice of how to approach the evaluation process depends on the following elements [5, 6]:

- nature of the job (permanent or temporary);
- process type (repetitive operations, variable / evolutionary processes);
- particularities of the workload (repetitive, occasional tasks, such as batch treatments or seasonal application of pesticides, high-risk tasks such as interventions in energy systems or penetration of isolated spaces);
- the technical complexity of the job.

In some cases, a single assessment that "covers" all the risks in a system, a job or an activity may be sufficient. In general, it is recommended to take different approaches depending on the purpose of the analysis and the information available in the preliminary analysis phase [7].

The investigated organization is one of the largest drilling companies in Romania, offering oil and gas drilling services, civil and industrial construction, general mechanics and carpentry. In terms of drilling services, the company performs the full range of services associated with drilling projects, starting with civil engineering works, transport services, assembly works, drilling, drilling fluid engineering, cementing works, geological cabin services, well drilling interventions and tests, commissioning of the well, dismantling works, restoration of the land in the agricultural circuit and restoration of the access road. Among the most important clients in the country of the company are OMV Petrom, Rompetrol, Amromco Energy, Stratum Energy Romania, Romgaz SA, etc. The organization's fleet of drilling rigs includes a number of 17 drilling rigs that have the possibility of drilling wells to a depth of 8500 m. From these, we selected in order to assess the risks at the “*drilling rig operator*” workplace, for two similar drilling rigs in terms of drilling capacity and performance up to a depth of 6000 m: drilling rig type F320-3DH, with drive diesel with three MB820 engines of 890 hp each and drilling winch of 2000 hp, manufactured in 1981; the other installation is Bentec 350t-AC, with diesel-electric drive with three CAT 3512 engines of 960 hp each and drilling winch of 1500 hp, manufactured in 2009.



In this paper we have evaluated the risks for the same job in both drilling rigs and the results obtained were studied comparatively in order to observe the impact of technological development on reducing exposure to risks in the workplace.

## **2. MATERIAL AND METHOD**

### ***2.1. The risk assessment tool***

Although there is no valid universal principle for occupational risk assessment methodology, two rules are still essential in the field [8]:

- the assessment must be structured in such a way that all potential hazards and risks are analyzed (for example, cleaning tasks will not be ignored, even if this activity is carried out outside the normal working hours) [9];
- when a risk has been identified, the first question to be answered is whether the associated hazard cannot be eliminated. [10].

Based on the essential elements listed above, different approaches (or combinations of approaches) can be adopted, usually involving the following operations:

- observation of the specific environment of the workplace (access roads, condition of buildings, safety of technical equipment, gas, dust, temperature, noise, lighting) [11];
- all job-specific tasks to be considered, in order to be sure that all will be taken into account in the assessment;
- analysis of the risks induced by the different work tasks [12];
- observing the manner in which the work processes are carried out, in order to verify the conformity of the applied procedures with the established ones and the existence / non-existence of additional risks;
- analysis of the modes of operation, for the evaluation of the exposure to hazard [13, 17];
- analysis of external influencing factors (meteorological factors, in case of outdoor works);
- detailed analysis of psychological, social and physical factors likely to contribute to stress at work, as well as their interaction with organizational and environmental factors;
- analysis of the provisions adopted to ensure safety conditions, in particular with regard to the existence of risk assessment systems due to new technologies and materials and the updating of risk information [16].

Out of the multitude of methods used worldwide and nationally for assessing the risks of occupational injury and illness, the most frequently used in Romania is the method of assessing the risks of occupational injury and illness developed by INCDPM Bucharest, approved by the Ministry of Labor and Social Protection in 1993, revised in 1996, edited in 1998 and reissued in 2002, experienced so far in most industries. It has already been a significant period since the recourse to the method developed by the I.N.C.D.P.M. Bucharest and, at European and global level, other methods of the same kind, called "quantification" of risks, are widely performed in the field of occupational

safety and health, to prioritize the risks of a trade, profession or job. Given the high level of knowledge of the method, we no longer consider it necessary to present its theoretical premises, specific tools and how to apply it [14, 15].

## **2.2. Brief description of the work system „Drilling rig operator”**

The work process aims to coordinate the drilling team in the well drilling activity. It is carried out according to the specific operational and technical procedures, the work instructions established and approved by the management of the unit. Coordinates and executes together with the team the drilling works at the well, the excavation works of the wells, carries out its activity in continuous work regime, in accordance with the established plan tasks, the provisions from the well execution project and the additional programs.

### **a. Means of production / work equipment**

- Service shed - desk, table, telephone, station, flashlight;
- Drilling rig - F320-3DH, BENTEC 350-t AC;
- All technical equipment, installations, technological networks, lifting and transport vehicles inside the company, from the work points, as well as those rented with the help of which the drilling equipment with which the personnel comes into contact during the performance of the work is transported;
- Apparatus, tools and equipment required in the activity (drilling tools: drilling rigs, stabilizers, drill rods, reducers, jaws, bolts, elevators, wedges, hammer, fixed wrenches, stamped cables, straps, etc.);
- SDV - Verification systems and devices, AMC - Measuring and control devices, DMM - Monitoring and measuring devices, other apparatus and equipment required for monitoring.

### **b. Work task**

The basic operations of the drilling activity are:

- drilling fluid preparation;
- inserting / removing the tubular material from the tower
- formation, introduction, extraction of the drilling rig;
- digging wells;
- tubing of sewer columns;
- cementing the columns;
- instrumentation in case of technical accidents;
- cleaning the beams;
- production samples.
- Knowledge and compliance with the provisions of GD 1050/2006 regarding the minimum requirements for ensuring the safety and health of workers in the extractive drilling industry;

- Compliance with the provisions of GD 1146/2006 regarding the minimum safety and health requirements for the use of work equipment by workers at work;
- Leads the activity on the shift or the drilling team that directly performs the excavation works of the wells and carries out its activity in a continuous working regime;
- Perform the drilling work on the well together with the team in accordance with the established plan tasks, the provisions of the well execution project and the additional programs;
- In order to carry out drilling work at appropriate quality conditions, he will coordinate the team in such a way as to comply with established technological programs, accident and eruption prevention regulations, fire prevention and extinguishing, occupational safety and health standards, compliance with procedures and of work instructions specific to the activity carried out, etc.;
- Performs drilling, shunting, tubing, production testing with drilling team;
- He is responsible for complying with the instructions received from the well chief;
- Checks and receives at the entrance in the shift, the situation of the well together with the tubular material inserted in the well, information about the depth of the well and the drilling parameters and reports to the head of the well the deficiencies found;
- He works on the well bridge together with the drilling team in the preparation and provision of the tubular material in the order of insertion or extraction.;
- While digging on the drilling foot, monitors compliance with drilling parameters by activating the commands available to him;
- Supervises the preparation, treatment and maintenance of the drilling fluid and receives information on the proper functioning of the vibrating screens that separate the detritus from the drilling fluid.;
- Supervises the cleaning and care of the tubular material (lubrication of the threads, calibration and recording of the tubular material introduced into the well), maintaining order on the ramp and in the chemical barracks;
- Oversees the preparation of the advancement piece;
- Supervises unloading, handling, tool storage, devices, materials, at the well;
- Supervises the maintenance of cleanliness on the well bridge and outside it, takes care of the good management of the material resources provided;
- Complies with the provisions of the internal regulations and the organization and functioning regulations of the company;
- Demonstrates loyalty to the company and maintains the confidentiality of data and information entrusted or aware of the company's activity;

- Responsible for the rational use of consumables, chemicals, fuel at the well, good management of the installation, equipment, devices, tools provided;
- Responsible for the execution in good condition, without technical and human accidents of all the operations it performs at the well;
- It has access to all the data and information necessary to carry out in quality conditions the works it performs and uses the equipment and materials provided by the company for the drilling works.

### **c. Work environment**

The performer carries out his activity in an open space. The activity takes place at the work points where the specific works contracted with the beneficiaries of drilling wells are performed.

- Explosive, flammable substances;
- Pneumoconogenic dusts, toxic gases emitted by the fluid used in drilling operations;
- Noise from drilling rigs, compressors, motors, as well as from other work equipment;
- Low temperatures in winter and high in summer, air currents;
- Insufficient lighting, exhaust fumes from the means of transport and lifting from the workplace as well as from the engines that drive the drilling rig;
- Toxic, corrosive, caustic substances used in mud treatment operations.

### **2.3. Risk identification and assessment**

Applying the tools and the procedure specific to the INCDPM Bucharest method, the concrete forms of manifestation of the risks were identified, the severity classes and the probability classes related to each of the identified risks were assigned, and then - using the scale of framing the risk levels, the partial risk levels were set.

The results obtained are centralized in Table 1 with the specification that the risks that were only identified at the drilling rig manufactured in 1981 are marked in RED, all other risks being common to the two drilling rigs analyzed.

The meaning of the notations in table 1 is as follows: *WSE* - Work system element; *IR* - identified risk; *RF* – risk factor; *MC* - Maximum consequence; *S* - Severity; *Likelihood*; *RL* - Risk level; *WE* - Working equipment; *OE* - Occupational environment; *WT* - Working task; *HF* - Human factor; *LTI 3-45* – Lost Time Injury from 3 to 35 days; *LTI 45-180* – Lost Time Injury from 45 to 180 days; *INV I* – first degree invalidity; *INV II* – second degree invalidity; *INV III* – third degree invalidity; *D* – death.

Table 1. Risk Assessment card

Unit: Onshore drilling rig		<b>RISK ASSESSMENT CARD</b>	Workers exposed: 12			
Drilling rig: F320- 3DH/ Bentec 350t-AC			Exposure length: 12 h/shift			
Drilling rig operator			Assessment Team: Moraru, R.I., Popescu- Stelea, M.			
WS E	IR	The concrete form of manifestation of risk factors (description, parameters)	MC	S	L	RL
0	1	2	3	4	5	6
WE	Mec h. RF	1. Hand grip, drive, body impact by moving machine parts (couplings, belt drives, fans, clamps, etc.) of technical equipment	D	7	3	5
		2. Hit by vehicles or haulage and lifting equipment due to deviations from normal trajectory caused by some technical failures, defective brakes, failure of drivers to insure when parking on sloping surfaces, skidding on wet, frozen surfaces	D	7	2	4
		3. Mechanical or thermal accidents caused by the installation of storage, cleaning, preparation and handling of drilling mud by leakage, spillage, eruption, jet of fluids at high temperature and pressure	D	7	2	4
		4. Sliding, rolling of the tubular material during its retrieval from the ramp in order to enter the tower	D	7	2	4
		5. Hitting the crane hook in the crown of the window due to failure of the crane stroke limiter, elongation of the chain	INV I	6	2	4
		6. Accidental starting of the stirrers during mud cleaning of the beams	D	7	2	4
		7. Load drop from crane hook due to rupture of unmanned steel cables for handled masses.	D	7	1	3
		8. Tubular material falls from the crane hook due to non-securing with chain pliers during assembly, disassembly of rods, during column tubing operation	D	7	1	3
		9. Falling objects, tools, parts from a height on the bridge deck, the bridge of the well, etc.	D	7	2	4
		10. Balance of masses transported by lifting means (cranes, lifting and towing equipment, etc.)	D	7	2	4
		11. Ejection of bodies, and particles from the means of transport, work equipment with unsecured, non-compliant fasteners, bolts, screws, nuts, valves, etc.)	D	7	2	4
		12. Ejection of subassemblies, parts, fittings, valves due to exceeding operating pressures, failure and defective assembly after repairs, overhauls.	D	7	3	5

		13. Deviation from the normal trajectory of the drive rod during its pulling and guiding in order to enter the pipe	D	7	1	3
		14. Drilling fluid spill on the well bridge	D	7	2	4
		15. Surfaces and parts with dangerous contours (slippery, sharp etc.)	INV III	4	2	3
		16. Eruptive manifestation, free eruption during the verification of logging and drilling works	D	7	2	4
		17. Jet of fluids at high temperature and pressure produced at the installation of storage, cleaning, preparation and handling of drilling mud by leakage, discharge, eruption	D	7	2	4
		18. Head and body hit by fluid jet with high pressure and temperature from the eruption prevention installation, motor pump groups, due to leaks in fittings, valves, use of unregulated and unmarked safety valves, etc.	D	7	2	4
		19. Hit the body by the jet of fluid under pressure when performing the check and hydraulic test at the pressure, of the installation, of the column, of the pipes, etc. due to improper seals	D	7	2	4
	Pressure vessel	20. Pressure vessels, boiler battery, air preparation units, compressed air containers, oil and oxygen or acetylene cylinders, etc.	D	7	2	4
	Vibration	21. Excessive vibrations, in the area of the well bridge, of the installation of storage, cleaning, preparation and handling of the drilling mud, of the installation of eruptions prevention, of the air preparation groups, of the groups motor-pump, etc.	D	7	2	4
		22. Low temperature of surface objects during the cold season	LTI 3-45	2	4	2
	Electrical RF	23. Direct contact electric shock due to protection or insulation defects in power cords or electrical installation.	D	7	1	3
		24. Indirect touch electrocution due to grounding faults or lack of protection circuits	D	7	1	3
	Chemical RF	25. Working with toxic substances - corrosives, additives, fuels used to treat mud etc.	LTI 45-180	3	5	4
		26. Flammable substances, flammable gases - lubricants, fuels - fire	D	7	2	4
		27. Explosive substances, gases, vapors resulting from emanations, eruptive manifestations - pressure vessels, pulsation dampers, air preparation units, etc.	D	7	3	5
		28. Skin conditions, contact dermatitis, contact with hands or other parts of the body with toxic, corrosive, caustic substances in the drilling fluid;	LTI 3-45	2	4	2
	Biological RF	29. Dangerous animals - vipers, venomous snakes, rodents	D	7	1	3
OE	Physical RF	30. Respiratory disorders due to low air temperature, exposure to the weather, during the cold season while traveling or checking workplaces	LTI 3-45	2	5	3

		31. Caloric cramps, sunburn due to high workplace temperatures and during the hot season	LTI 3-45	2	4	2
		32. Air currents when moving from one job to another while performing work	LTI 45-180	3	5	4
		33. Increased humidity during the cold season, or with precipitation	LTI 45-180	3	3	3
		34. Diseases of the osteo-articular system, dorso-lumbar diseases, sciatica, due to exposure to variable microclimate conditions, high / low temperatures, bad weather, high speed air currents, high humidity, through permanent outdoor activity	LTI 45-180	3	5	4
	Ligh ting	35. Insufficient lighting in some workplaces, well cellar, etc.	LTI 3-45	2	5	3
	Nois e	36. Noise from drilling rig work equipment (compressors, boiler battery, air preparation units, eruption prevention plant, etc.) - hearing loss	INV III	4	4	4
		37. Circulatory disorders, high blood pressure due to noise and vibration	D	7	1	3
		38. Disorders of the digestive tract, gastrointestinal tract, labyrinthine hyper excitability, visual disturbances, irritability, depression, asthenia due to noise, vibration.	D	7	1	3
		39. Natural disasters - collapse (earthquake, lightning, wind, hail, blizzard, landslides, etc.)	D	7	3	5
	Che mica l R F	40. Toxic gases, vapors suspended in the air from the emanations resulting from the gasification of the drilling fluid	D	7	3	5
		41. Digestive poisoning and / or respiratory problems due to pneumoconio-genic particles (cement dust, additives, etc.) during the supervision of drilling fluid quality improvement operations.	LTI 3-45	2	4	2
WT	Inad equat e WT cont ent	42. Improper work loading, coordination, poor supervision of work operations, incomplete training for eruptions, fires, explosions, emergencies, etc.	D	7	2	4
		43. The danger of being killed or taken hostage both in the country and abroad	D	7	1	3
	Phys ical over load	44. Very high dynamic physical effort, with intense metabolism	LTI 45-180	3	6	5
		45. Professional gestures with high amplitudes of the joint movements, with sudden movements, requiring great force and with elements of static contractions of some muscle groups during the work load	INV II	5	3	4
		46. Activity in orthostatic posture, work at height, forced, vicious work positions, involving static effort of postural muscles	LTI 45-180	3	6	5
		47. Constraints of an organizational nature determined by the pace imposed by the need to comply with emergency requirements in the activity, recovery times that do not allow sufficient physical rest	LTI 45-180	3	5	4

	Psyc hic overl oad	48. Working under stress, neuropsychological sensory overload. caused by: - the responsibility imposed by the workplace, difficult decisions in a short time; demanding pace of work, danger of fire, explosion at work, living conditions away from family	LTI 3-45	2	5	3
HF	Wro ng actio ns	49. Failure to insure work equipment during the intervention, tests performed after overhauls and repairs, relocation	D	7	3	5
		50. Incorrect coordination of the following operations: handling the masses, materials with the help of the crane; screwing or unscrewing the feed rod; pulling the rope on the spool; maneuvering the elevators at the mouth of the well, other operations carried out on the well's bridge	D	7	3	5
		51. Use of non-dimensioned cables when fastening, tying the masses handled with the crane	D	7	1	3
		52. Carrying out various interventions on machinery and equipment, in which the guard / housings / protection devices were removed during their operation	D	7	2	4
		53. Unbalance of the load with the help of chain pliers, improper binding of the masses, materials handled with the help of the crane	D	7	1	3
		54. Flipping the manifold during mounting on the connection pipe to the preventer due to a wrong maneuver	D	7	1	3
		55. Interventions on table squares with levers, hooks, etc. when the table is moving or when the feathered rods are twisted	D	7	1	3
		56. Improper placement of personal items, tools on the guards of the transmission, on the bridge of the rig	D	7	1	3
		57. Non-synchronization of operations - delays or advances in teamwork when performing interventions during an eruption	D	7	2	4
		58. Failure to follow working and safety instructions, (Leaving the winch brake during the operation of the installation; Working simultaneously with two ropes or with a cable on the spool; Use of the spool without crease separator when working on the working bridge of the drilling rig, etc.)	D	7	3	5
		59. Hit by mudguard due to mounting on the left side instead of the right side of the well bridge	D	7	1	3
		60. Hitting by drilling pliers not anchored to the side walls or toes of the tower (their balance)	D	7	2	4
		61. Clamping the fingers between the rope, the chain and the rod during the operation of screwing-unscrewing the rod with the help of a calibrated rope or chain	D	7	1	3
		62. Falling objects, tools, tools from a height on the bridge deck, well bridge, etc.	D	7	2	4
		63. Falling from a height during installation and tightening of the studs in the eruption prevention installation due to the use of inadequate protective equipment	D	7	1	3
64. Staying in the hazardous area of high pressure valves, mud pump compression body covers, in the probe cellar during the handling of the preventer, during installation with improper devices	D	7	1	3		
65. Standing in the range of the drilling pliers while tightening or loosening the tubular material, placing the foot on the rotary table when the table is moving, in the area of the pole lift	D	7	2	4		



		66. Standing in hazardous areas (access roads, vehicles, transport and lifting, technical equipment);	D	7	2	4
		67. Falling from a height due to imbalance, slipping on the access stairs to the well bridge and / or due to the lack of barriers along the length of the access roads	D	7	3	5
		68. Fall at the same level due to slipping on free leaks of oil, drilling fluid, mud, water from rainfall, leaking pipes from utilities, condensation, imbalance of materials, improperly stored parts, etc.	D	7	1	3
	Omissions	69. Failure to use the protective equipment provided (helmet, seat belt, harness, goggles, lap belt, etc.)	D	7	3	5

### 3. RESULTS AND DISCUSSION

The overall risk level of the F320-3DH „drilling rig operator” is:

$$N_{rg} = \frac{\sum_{i=1}^{69} r_i \cdot R_i}{\sum_{i=1}^{69} r_i} = \frac{12 \cdot (5 \times 5) + 29 \cdot (4 \times 4) + 24 \cdot (3 \times 3) + 4 \cdot (2 \times 2)}{12 \times 5 + 29 \times 4 + 24 \times 3 + 4 \times 2} = \frac{996}{256} = 3,89$$

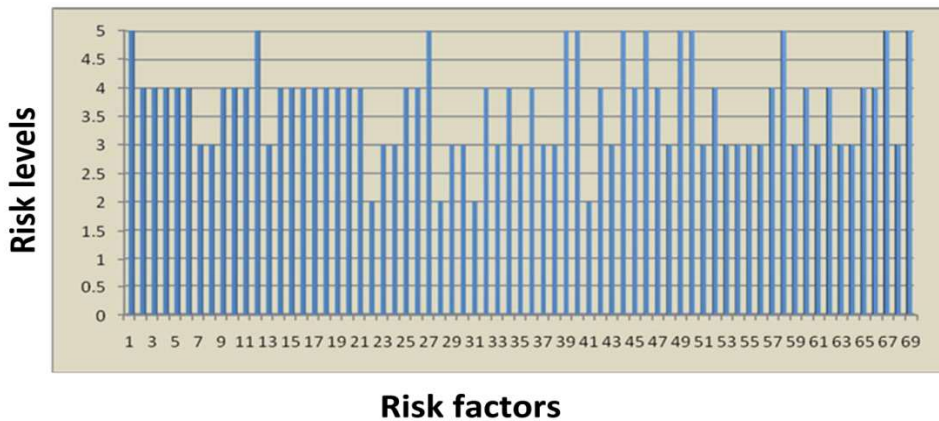

**Figure 1.** Partial risk levels by risk factors. Job: „drilling rig operator” on drilling rig F320-3DH. Overall risk level: 3.89

The overall risk level of the Bentec 350t-AC „drilling rig operator” is:

$$N_{rg} = \frac{\sum_{i=1}^{57} r_i \cdot R_i}{\sum_{i=1}^{57} r_i} = \frac{3 \cdot (5 \times 5) + 19 \cdot (4 \times 4) + 27 \cdot (3 \times 3) + 8 \cdot (2 \times 2)}{3 \times 5 + 19 \times 4 + 27 \times 3 + 8 \times 2} = \frac{684}{188} = 3,32$$

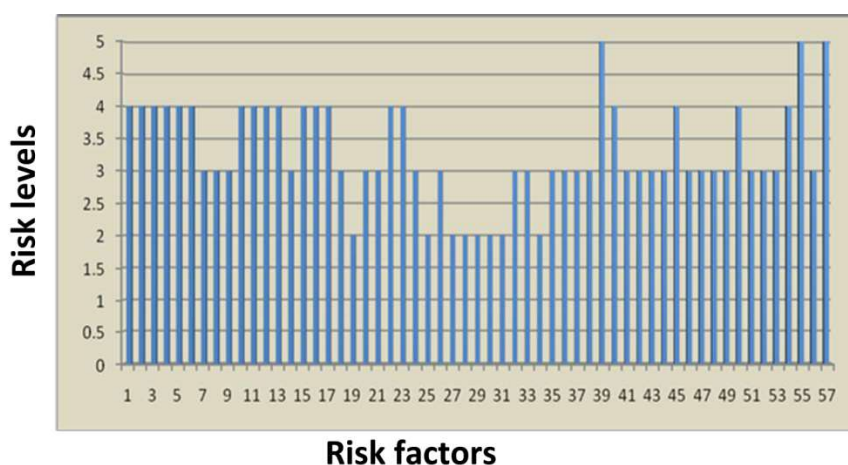

**Figure 2.** Partial risk levels by risk factors. Job: „drilling rig operator" on drilling rig Bentec 350t-AC. Overall risk level: 3.32

The overall risk level calculated for the “*drilling rig operator*” job on the F320-3DH drilling rig (figure 3) has a value of 3.89 which represents a much higher degree of risk at the workplace, compared to the level of risk globally calculated for the same job, on an automated drilling rig Bentec 350t-AC (figure 4), for which the value of 3.32 was obtained. In order to argue the conclusions, in the following are presented representative photos with the analyzed job.

In order to be able to compare the two values obtained of the overall risk level for the same job on two different drilling rigs, we should first consider the existence of *two dimensions* of this difference: *the quantitative dimension* - given by the figures obtained and *the qualitative dimension* - which consists in the physical and mental influence of the improvements of the means of work and of the work environment on the occupant of the job.

*From a quantitative point of view*, we can draw the following conclusions from the previous risk assessment:

- Decreasing the overall risk level from 3.89 in the first case to 3.32 in the second; expressed as a percentage this difference is almost 15%;
- The number of risk factors has decreased substantially, from a number of 69 risk factors in the first case to 57 risk factors in the second case; as in the global risk level case, expressed as a percentage, this difference has the value of 17%;
- Another improvement that can be expressed quantitatively is that of the number of high level risk factors (value 4 and 5). In the first case, there are 41 high-level risk factors (12 level 5 risk factors and 29 level 4 risk factors) compared to the second case in which the number of high-level risk factors decreased considerably: 22 (3 level 5 risk factors and 19 level 4 risk factors);
- Similar to high level risk factors, medium / low level risk factors can be quantified (values 2 and 3). Thus, the number of these risk factors

increased from a number of 28 in the first case to a number of 35 in the second case.

Thus, a first conclusion that can be drawn after assessing the risks of the “drilling rig operator” job is that, over time, the advancement of technology and therefore, implicitly of the means of work, contributes to a very important extent to the increase of safety at the workplace. This change in the value of the risk level of the workplace, analyzed from a quantitative point of view, indicates that, where possible, a number of risks have been eliminated and another part of the risks to which the operator is exposed have been minimized.

*From the second point of view, the qualitative one*, the work environment is much improved, by:

- Replacing the dials and analog manometers with digital monitoring devices (except the drill meter) much easier to track, has reduced the effort made by the operator in monitoring the drilling parameters (fig. 6);
- The controls of the equipment used have become from levers with manual operation buttons with immediate reaction or adjusting potentiometers (fig. 7);
- A very important change in the means of work is that the brake lever of the grinder and the drill string has been transformed from a metal lever into an electronic "joystick" (fig. 8);
- At the same time it can be noticed that the ergonomics of the workplace has changed: in the first case the worker carries out the activity in an orthostatic position, a tiring position considering the daily duration of the work schedule of 12 hours. The working position has become "seated" in an ergonomic chair that has various adjustments to ensure maximum operator comfort and access to the multitude of controls as well as a visibility of the entire well's bridge, the place of activity;
- Addition of soundproof and thermally insulated head drill cab to protect the operator against temperature variations and avoid acoustic shocks, with a very large glazed surface in order to ensure visibility, metal grilles have been installed to protect the roof windows against possible falling objects from the installation tower, telephone and intercom were installed to communicate with the other sectors of activity (engine room, mud pumps, chemical mixers, mud washers, offices) within the installation (fig. 5).

All these improvements reduce the operator's movement effort in the idea of leaving more energy to monitor the equipment. The work environment is safer and more comfortable, which has a beneficial effect on the worker. We can say that also from a qualitative point of view, the changes brought to the workplace by improving the working equipment and the work environment, the transformation is a major one.

From an organizational point of view, the task of the chief driller to coordinate the activities and operations during drilling wells has not changed, however, by increasing the level of technology and changes in the environment and equipment, the task of the human operator becomes easier to do, also reducing possible operating errors. These changes observed in the analysis are summarized in the graphs in Fig. 9 and Fig. 10.



**Figure 3.** F320-3DH drilling rig



**Figure 4.** Bentec 350t-AC drilling rig



**Figure 5.** Drilling rig's operator working station



**Figure 6.** Drilling parameters monitoring boards



Figure 7. Control panels of used equipment



Figure 8. Drill winch brake control lever / "Joystick" control lever

In comparison, the percentage changes analyzed by risk-generating sources and which were the basis for the conclusions drawn from the results obtained from the calculations of the global level of risk at the “drilling rig operator” workplace are presented in table 2:

**Table 2.** Percentage difference in quantitative changes of risk factors for the analyzed job

<b>Risk generating source</b>	<b>F 320-3DH</b>	<b>Bentec 350t-AC</b>	<b>Difference (%)</b>
Equipment	29	26	-10.34
Working environment	12	8	-33.33
Work task	7	7	0.00
Human factor	21	16	23.81
<b>TOTAL NO. OF RISK FACTORS</b>	<b>69</b>	<b>57</b>	<b>17.39</b>
<i>Global risk level</i>	<i>3.89</i>	<i>3.32</i>	<i>14.65</i>

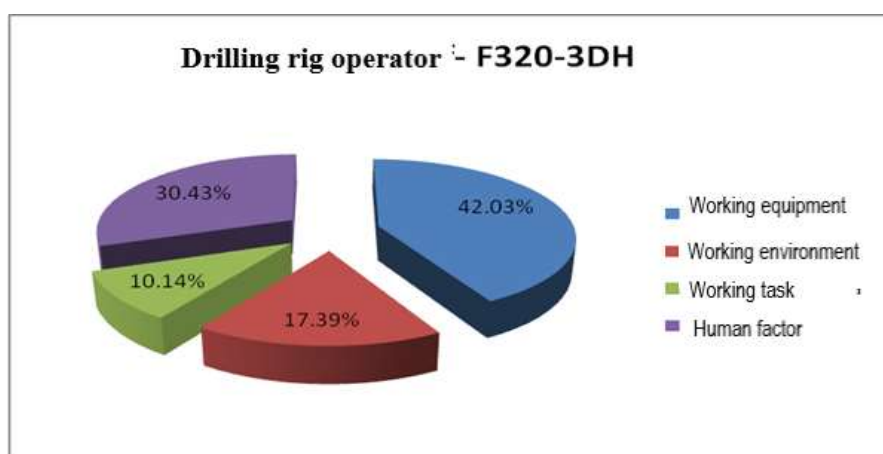

Figure 9. The share of risk factors identified by the generating source within the work system at the drilling rig F320-3DH

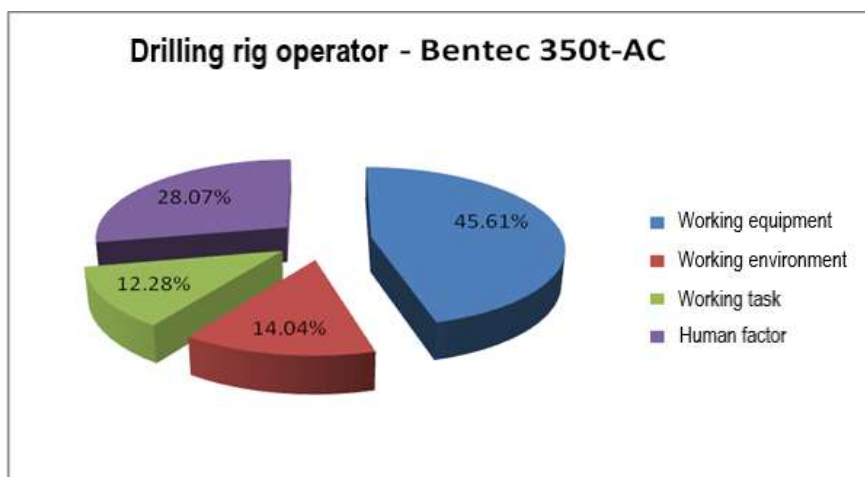

Figure 10. The share of risk factors identified by the generating source within the work system at the drilling rig Bentec 350t-AC

#### 4. CONCLUSIONS

As can be seen from the research carried out, at the same workload, under different conditions, not only the number of risk factors have decreased but also the overall risk level of the job is considerably reduced by almost 15%. Finally, for the “drilling rig operator” job, following the application of the I.N.C.D.P.M. two values were obtained: 3.89 for the F320-3DH drilling rig and 3.32 for the Bentec 350t-AC drilling rig. Thus, the second value falls into the category of "low-risk jobs" being below the maximum acceptable limit ( $3 < 3.44 < 3.5$ ), which proves that always in the field of health and safety in risk factors are controllable and also the prevention of risk exposure can lead to the avoidance of accidents or unwanted events.

Currently, more and more experts in the field criticize the limitations and disadvantages of this category of evaluation methods, considering them incomplete, unreliable, with a too pronounced subjective character. Other experts have clarified their views, proposing that such methods be applied only as complementary or informative tools.

However, the method applied has many advantages such as, for example, accessibility, simplicity of application and the possibility of using it to introduce the notions of probability, frequency and severity to workers in a qualitative manner. As a result, the method can be an ideal tool for raising staff awareness. As long as certain elements are not neglected, the method retains its purpose and *raison d'être*. First of all, this method remains very useful for ensuring the monitoring of the implementation of prevention measures. On the other hand, it is (or should be) a participatory and therefore didactic method. Applied in a working group, the method can be a valuable tool, as it is not complicated and allows for reflections on the basic components of risks.

## 5. REFERENCES

- [1] Bedford, T., Cooke, R., Probabilistic risk analysis - Foundation and methods, Cambridge University Press, 2001.
- [2] Cioca, M.; Cioca, L. I.; Duta, L. Web technologies and multi-criteria analysis used in enterprise integration, *Studies in informatics and control* 20 (2), 130, 2011.
- [3] Cioca, M.; Cioca, L. I. Multi-criterion analysis of reference architectures and modeling languages used in production systems modeling, *INDIN'05. 2005 3rd IEEE International Conference on Industrial Informatics*, 2005.
- [4] Darabont, A., ș.a., Evaluation of the security quality of technical equipment (in Romanian), AGIR Publishing House, Bucharest 2001
- [5] Guvernul României, H.G. no. 1425/2006 for the approval of the Methodological Norms for the application of the provisions of the Law on safety and health at work no. 319/2006, *Official Gazette of Romania, Part I*, no. 882 / 30.10.2006.
- [6] Guvernul României, H.G. no. 955/2010 for the modification and completion of the Methodological Norms for the application of the provisions of the Law on safety and health at work no. 319/2006, approved by H.G. no. 1425/2006, *Official Gazette of Romania, Part I*, no. 661 / 27.09.2010.
- [7] Joy, J., Griffiths, D., National minerals industry safety and health risk assessment guideline, version 3, March 2008, MCA and MISHC, Australia, [www.planning.nsw.gov.au](http://www.planning.nsw.gov.au)
- [8] Moraru, R.I., Current Trends and Future Developments in Occupational Health and Safety Risk Management în Roland Iosif Moraru (2012). *Current Trends and Future Developments in Occupational Health and Safety Risk Management, Risk Management for the Future - Theory and Cases*, Dr Jan Emblemşvåg (Ed.), , InTech, DOI: 10.5772/1809
- [9] Moraru, R.I., Occupational safety and health. University treaty. (in Romanian) FOCUS Publishing House, Petroşani, 2013
- [10] Moraru, R.I, Băbuş, G.B., Cioca, L.I., Knowledge Based Hazard Analysis Guidelines for Operational Transportation Projects, *Proceedings of the 15th International Conference the Knowledge Based Organization: Management*, Volume 2, pp. 117-122, Sibiu, Romania, 26-28.11.2009.
- [11] Neal, A., Griffin, M.A., Hart, P.M., The impact of organizational climate on safety climate and individual behavior, *Safety Science*, vol. 34, pag. 99-109. 2000.

- [12] Niskanen, T., Assessing the safety environment in work organization of road maintenance jobs. *Accident Analysis and Prevention* (26), pp. 27–39, 1994.
- [13] Ostroff C, Kinicki AJ, Tamkins MM. Organizational culture and climate. In *Handbook of Psychology: Industrial and Organizational Psychology*, ed. WC Borman, DR Ilgen, RJ Klimoski, vol. 12, pp. 565–93, New York: Wiley, 2003.
- [14] Paques, J.J., Gauthier, F., Pérez, A., Charpentier, F. Bilan raisonné des outils d’appréciation des risques associés aux machines industrielles, R-459, IRSST, Canada, (www.irsst.qc.ca), 2006.
- [15] Rasmussen, J., Risk management in a dynamic society: a modelling problem. *Safety Science*, vol. 27, nr. 2-3/, pp. 183-213, 1997.
- [16] Romanian Parliament, Occupational safety and health law no. 319/2006, Official Gazette of Romania, Part I, no. 646 / 26.07.2006.
- [17] Vasilescu, G., Unconventional methods of occupational risk analysis and assessment (in Romanian), ISBN 978-973-88590-0-5, INSEMEX Publishing House, 2008.



## INDEX OF AUTHORS

<b>A</b>	<b>H</b>	<b>R</b>
Apostu, I.M. – 185	Hulea, L. – 151	Roman, L. – 53
<b>B</b>	<b>M</b>	<b>S</b>
Bădulescu, C. – 157, 175, 185	Mangu, S.I. – 135, 143 Marian, D.P. – 41, 99, 113 Moraru, R.I. – 207	Sîli, N. – 185
<b>C</b>	<b>N</b>	<b>T</b>
Ciolea, D.I. – 165	Nimară, C. – 35, 195, 201	Terleccki A.E. – 5 Tiuzbăian, I.N. – 151 Tomuş, A.V. – 127
<b>D</b>	<b>O</b>	<b>V</b>
Dima, N. – 81	Onica, I. – 41, 99, 113	Vangu, G.M. – 81
<b>G</b>	<b>P</b>	
Georgescu, M. – 5, 127	Popescu-Stealea, M. – 207	

## INSTRUCTIONS FOR AUTHORS PAPER TITLE TNR 14p bold

Author 1 Surname, Name<sup>1</sup>, Author 2 Surname Name<sup>2</sup> TNR 12p bold

**Abstract:** 5-15 lines, TNR 10p italic

**Keywords:** 4-7 key words, TNR 10p italic

### 1. INTRODUCTION, TNR 11p bold

Body text, 11p normal, paragraph first line 12.5 mm.

### 2. TITLE HEADER, TNR 11p bold

#### 2.1. Subtitle header, TNR 11p bold italic

Body text, 11p normal, paragraph first line 12.5 mm.

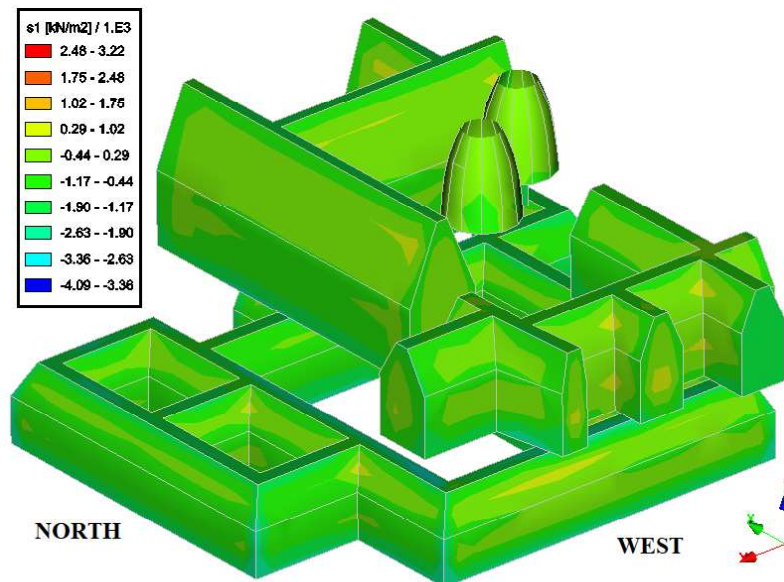

Figure 1. Figure title 10p TNR

---

<sup>1</sup> Author 1 title, affiliation

<sup>2</sup> Author 2 title, affiliation

**Table 1.** Table title 10p TNR

<b>Heading 1</b>	<b>Heading 2</b>	<b>10p TNR bold</b>		
Content 1	Content 2	10p TNR		

Formula, TNR 11p alignment right (1)

## ***2.2. Subtitle header, TNR 11p bold italic***

Body text, 11p normal, paragraph first line 12.5 mm. Body text, 11p normal, paragraph first line 12.5 mm. Body text, 11p normal, paragraph first line 12.5 mm. Body text, 11p normal, paragraph first line 12.5 mm. Body text, 11p normal, paragraph first line 12.5 mm. Body text, 11p normal, paragraph first line 12.5 mm. Body text, 11p normal, paragraph first line 12.5 mm. Body text, 11p normal, paragraph first line 12.5 mm. Body text, 11p normal, paragraph first line 12.5 mm. Body text, 11p normal, paragraph first line 12.5 mm. Body text, 11p normal, paragraph first line 12.5 mm.

Body text, 11p normal, paragraph first line 12.5 mm. Body text, 11p normal, paragraph first line 12.5 mm. Body text, 11p normal, paragraph first line 12.5 mm. Body text, 11p normal, paragraph first line 12.5 mm. Body text, 11p normal, paragraph first line 12.5 mm. Body text, 11p normal, paragraph first line 12.5 mm. Body text, 11p normal, paragraph first line 12.5 mm. Body text, 11p normal, paragraph first line 12.5 mm. Body text, 11p normal, paragraph first line 12.5 mm. Body text, 11p normal, paragraph first line 12.5 mm. Body text, 11p normal, paragraph first line 12.5 mm.

Body text, 11p normal, paragraph first line 12.5 mm. Body text, 11p normal, paragraph first line 12.5 mm. Body text, 11p normal, paragraph first line 12.5 mm. Body text, 11p normal, paragraph first line 12.5 mm. Body text, 11p normal, paragraph first line 12.5 mm. Body text, 11p normal, paragraph first line 12.5 mm. Body text, 11p normal, paragraph first line 12.5 mm. Body text, 11p normal, paragraph first line 12.5 mm. Body text, 11p normal, paragraph first line 12.5 mm. Body text, 11p normal, paragraph first line 12.5 mm. Body text, 11p normal, paragraph first line 12.5 mm.

Body text, 11p normal, paragraph first line 12.5 mm. Body text, 11p normal, paragraph first line 12.5 mm. Body text, 11p normal, paragraph first line 12.5 mm. Body text, 11p normal, paragraph first line 12.5 mm. Body text, 11p normal, paragraph first line 12.5 mm. Body text, 11p normal, paragraph first line 12.5 mm. Body text, 11p normal, paragraph first line 12.5 mm. Body text, 11p normal, paragraph first line 12.5 mm. Body text, 11p normal, paragraph first line 12.5 mm. Body text, 11p normal, paragraph first line 12.5 mm. Body text, 11p normal, paragraph first line 12.5 mm.

Body text, 11p normal, paragraph first line 12.5 mm. Body text, 11p normal, paragraph first line 12.5 mm. Body text, 11p normal, paragraph first line 12.5 mm. Body text, 11p normal, paragraph first line 12.5 mm. Body text, 11p normal, paragraph first line 12.5 mm. Body text, 11p normal, paragraph first line 12.5 mm.

### **3. CONCLUSIONS**

Body text, 11p normal, paragraph first line 12.5 mm. Body text, 11p normal, paragraph first line 12.5 mm. Body text, 11p normal, paragraph first line 12.5 mm. Body text, 11p normal, paragraph first line 12.5 mm. Body text, 11p normal, paragraph first line 12.5 mm. Body text, 11p normal, paragraph first line 12.5 mm. Body text, 11p normal, paragraph first line 12.5 mm. Body text, 11p normal, paragraph first line 12.5 mm. Body text, 11p normal, paragraph first line 12.5 mm. Body text, 11p normal, paragraph first line 12.5 mm. Body text, 11p normal, paragraph first line 12.5 mm. Body text, 11p normal, paragraph first line 12.5 mm. Body text, 11p normal, paragraph first line 12.5 mm.

### **4. REFERENCES**

[1]. Author, Paper title, Publisher (year) – TNR, 10p

**Do not insert page numbers**

## SCIENTIFIC REVIEWERS

*Commission reviewers for article in the journal „Annals of the University of Petroșani - Mining Engineering”*

### FIELDS OF COMPETENCE

- ✓ **MINING ENGINEERING:**
  - Prof. PhD. Eng. Iosif ANDRAȘ - University of Petroșani
  - Prof. PhD. Eng. Eugen COZMA - University of Petroșani
  - Prof. PhD. Eng. Dumitru FODOR - University of Petroșani
- ✓ **MINING SURVEYING:**
  - Prof. PhD. Eng. Nicolae DIMA - University of Petroșani
  - Prof. PhD. Eng. Mircea ORTELECAN - U.S.A.M.V. Cluj Napoca
  - Prof. PhD. Eng. Ioel VEREȘ - University of Petroșani
- ✓ **MANAGEMENT IN MINING**
  - Prof. PhD. Eng. Florian BUȘE - University of Petroșani
  - Prof. PhD. Eng. Tudor GOLDAN - University of Petroșani
  - Prof. PhD. Eng. Andreea IONICĂ - University of Petroșani
  - Assoc. Prof. PhD. Eng. Dumitru JULA - University of Petroșani
  - Assoc. Prof. PhD. Lavinia Elisabeta POPP - University “Eftimie Murgu” Reșița
  - Prof. PhD. Eng. Sorin-Mihai RADU - University of Petroșani
- ✓ **ENGINEERING AN ENVIRONMENTAL PROTECTION:**
  - Prof. PhD. Eng. Ioan DUMITRESCU - University of Petroșani
  - Assoc. Prof. PhD. Eng. Emilia DUNCA
  - Prof. PhD. Eng. Mircea GEORGESCU - University of Petroșani
  - Prof. PhD. Eng. Maria LAZĂR - University of Petroșani
- ✓ **MINE CONSTRUCTION:**
  - Prof. PhD. Eng. Constantin SEMEN - University of Petroșani
  - Prof. PhD. Eng. Mihaela TODERAȘ - University of Petroșani
- ✓ **VENTILATION AN MINE SAFETY:**
  - Prof. PhD. Eng. Nicolae BĂNCILĂ - University of Petroșani
  - Prof. PhD. Eng. Roland MORARU - University of Petroșani
- ✓ **PROCESSING OF MINERAL RESOURCES:**
  - Assoc.Prof. PhD. Eng. Nicolae CRISTEA - University of Petroșani
  - Prof. PhD. Eng. Sanda KRAUSZ - University of Petroșani
- ✓ **MINING GEOLOGY**
  - Prof. PhD.Eng. Grigore BUIA - University of Petroșani
  - Assoc.Prof.PhD. Laura COMĂNESCU - Universitatea din București
- ✓ **ROCK ENGINEERING**
  - Prof. PhD.Eng. Victor ARAD - University of Petroșani
  - Prof. PhD.Eng. Ioan BUD - University of Petroșani

## **REVIEWERS OF THE CURRENT VOLUME**

Prof. PhD. Eng. BUIA Grigore;  
Prof. PhD. Eng. COZMA Eugen;  
Assoc. Prof. PhD. Eng. FILIP Larisa Ofelia;  
Prof. PhD. Eng. GEORGESCU Mircea;  
Prof. PhD. Eng. LAZĂR Maria;  
Lecturer PhD. Eng. MANGU Sorin;  
Lecturer PhD. Eng. RADERMACHER Ladislau;  
Lecturer PhD. Eng. TIUZBĂIAN Ioan Nicolae;  
Assoc. Prof. PhD. Eng. TRAIȘTĂ Eugen;  
Scientific researcher I, PhD. Habil. Eng. VASILESCU Gabriel-Dragoș;